



Urologie | Urologie
Urology | *Urología*
Urologia



Nierensteinzangen
Kidney stone forceps

Pinces pour les calculs rénaux
Pinzas para cálculos renales
Pinze per calcoli renali

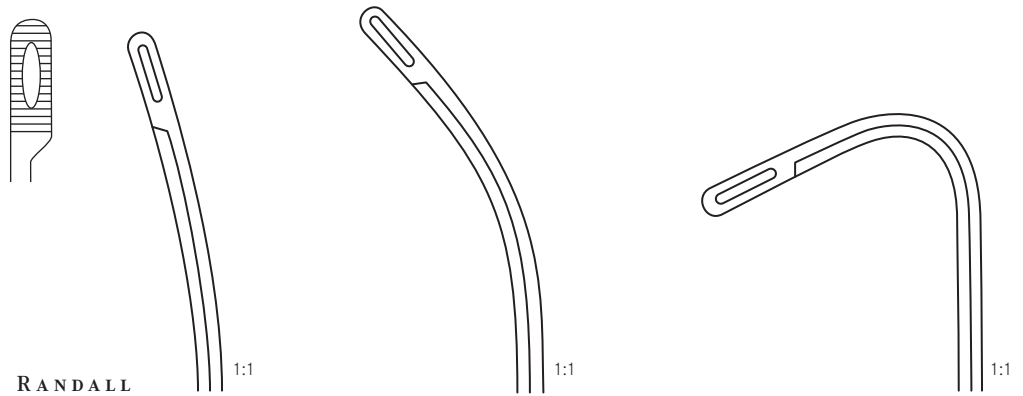

RANDALL		
Fig. 1	Fig. 2	Fig. 3
230 mm – 9"	220 mm – 8¾"	190 mm – 7½"
tk 30221-23	tk 30222-22	tk 30223-22

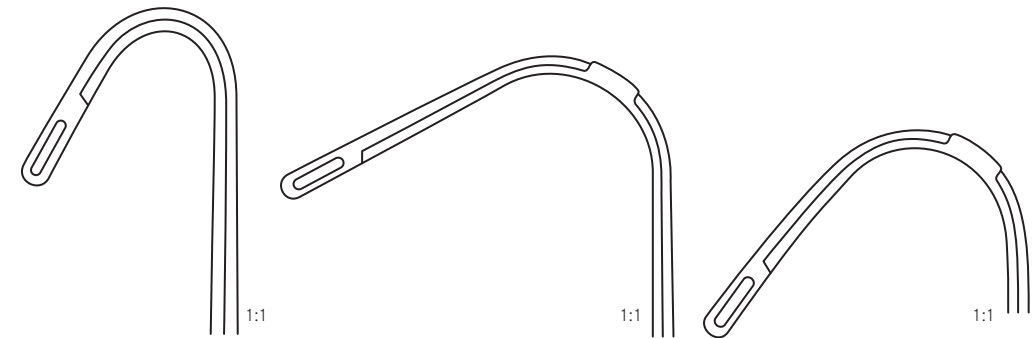
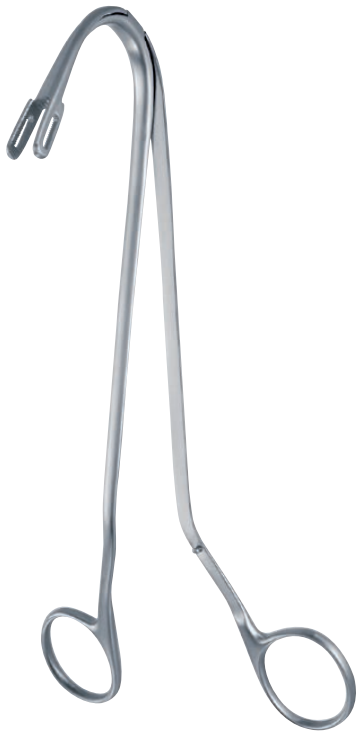

Fig. 4	Fig. 5	Fig. 6
190 mm – 7½"	190 mm – 7½"	190 mm – 7½"
tk 30224-22	tk 30225-19	tk 30226-19

Gallenstein-Instrumente
Gall stone instruments

Instruments pour calculs biliaires
Instrumental para coger cálculos biliares
Strumenti per canali bilari



1:3

	1 mm	2 mm	3 mm	4 mm	5 mm	6 mm	7 mm
	1:1	1:1	1:1	1:1	1:1	1:1	1:1
BAKES	Fig. 1	Fig. 2	Fig. 3	Fig. 4	Fig. 5	Fig. 6	Fig. 7
300 mm – 12"	tk 30100-01	tk 30100-02	tk 30100-03	tk 30100-04	tk 30100-05	tk 30100-06	tk 30100-07

biegsam
malleable
malléable
malleable
flessibile

	8 mm	9 mm	10 mm	11 mm	12 mm	13 mm
	Fig. 8	Fig. 9	Fig. 10	Fig. 11	Fig. 12	Fig. 13
300 mm – 12"	tk 30100-08	tk 30100-09	tk 30100-10	tk 30100-11	tk 30100-12	tk 30100-13

biegsam
malleable
malléable
malleable
flessibile



1:3

	1:1	1:1	1:1
DESJARDINS	Fig. 1	Fig. 2	Fig. 3
280 mm – 11"	tk 30260-01	tk 30260-02	tk 30260-03

federnd
elastic
élastique
elastica
elastico

Gallenstein-Instrumente
Gall stone instruments

Instruments pour calculs biliaires
Instrumental para coger cálculos biliares
Strumenti per canali bilari



1:3

DESJARDINS



1:1



1:1



1:1



1:1

	Fig. 1	Fig. 2	Fig. 3	Fig. 4
300 mm – 12"	tk 30110-01	tk 30110-02	tk 30110-03	tk 30110-04

federnd
elastic
élastique
elastica
elastico



1:3

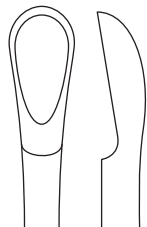

1:1



1:1

MOYNIHAN

	x = 5 mm
340 mm – 13½"	tk 30258-34

biegsam
malleable
malléable
maleable
flessibile

Gallensteinlöffel
Gall stone scoops

Curettes pour calculs biliaires
Cucharillas para coger cálculos biliares
Cucchiai per colcoli bilari



LUER-KOERTE



1:1



1:1



1:1



1:1

	Fig. 000	Fig. 00	Fig. 0	Fig. 1
320 mm – 12½"	tk 30285-01	tk 30285-02	tk 30285-03	tk 30285-04

biegsam, stumpf
malleable, blunt
malléable, mousse
maleable, roma
flessibile, smussa



1:1



1:1



1:1



1:1

	Fig. 2	Fig. 3	Fig. 4	Fig. 5
320 mm – 12½"	tk 30285-05	tk 30285-06	tk 30285-07	tk 30285-08

biegsam, stumpf
malleable, blunt
malléable, mousse
maleable, roma
flessibile, smussa



MAYO

280 mm – 11"	tk 30290-28
--------------	--------------------

1:2



FERGUSSON

215 mm – 8½"	220 mm – 8¾"	235 mm – 9¼"
tk 30295-21	tk 30295-22	tk 30295-23



1:1



1:1



1:1



1:1



1:1



1:1

Gallenstein-Instrumente
Gall stone instruments

Instruments pour calculs biliaires
Instrumental para coger cálculos biliares
Strumenti per canali bilari



BLAKE

200 mm – 8"



1:1

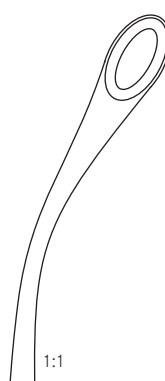

1:1

tk 30200-20

tk 30201-20



DESJARDINS

230 mm – 9"



1:1



1:1

tk 30210-23

tk 30212-23

Gallenstein-Instrumente
Gall stone instruments

Instruments pour calculs biliaires
Instrumental para coger cálculos biliares
Strumenti per canali bilari



CZERNY

245 mm – 9¾"

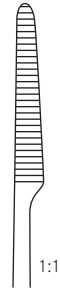

1:1

tk 30267-25



TURNER-
WARWICK

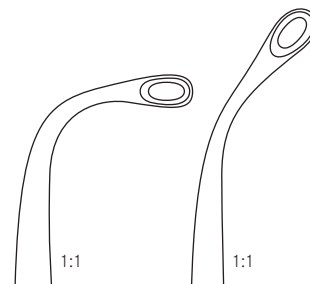

1:1

1:1

180 mm – 7"

190 mm – 7½"

tk 30265-18

tk 30265-19

Prostatahaken
Prostatic retractors

Ecarteurs prostatiques
Separadores para la próstata
Divaricatori prostatici



YOUNG

tk 30300-21 | 210 mm – 8 1/4"

1:2



YOUNG

tk 30302-22 | 220 mm – 8 3/4"

1:2



YOUNG

tk 30304-21 | 210 mm – 8 1/4"

1:2



YOUNG

tk 30306-22 | 220 mm – 8 3/4"

1:2

Instrumente für Prostata-Operationen
Prostatectomy instruments

Instruments pour prostatectomie
Instrumentos para prostatectomía
Strumenti per operazioni della prostata

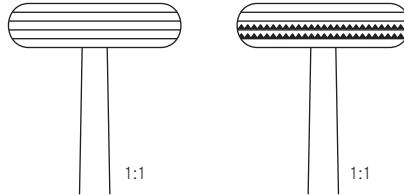

MILLIN

230 mm – 9"	235 mm – 9 1/4"
tk 30320-23	tk 30328-24 Atrauma

Kapselfasszange zur retropubischen Prostatektomie
Capsule forceps for retropubic prostatectomy

Pince pour saisir les capsules pour la prostatectomie rétropubique
Pinza capsular para le prostatectomía retropúbica
Pinza a capsula per prostatectomia retropubica



MILLIN

230 mm – 9"	tk 30322-23
-------------	--------------------

Fasszange für die vorderen Lappen
Prostatic lobe holding forceps

Pince pour saisir les lambeaux
Pinza para coger los lóbulos anteriores
Pinza da presa per lobo prostatico

Instrumente für Prostata-Operationen
Prostatectomy instruments

Instruments pour prostatectomie
Instrumentos para prostatectomía
Strumenti per operazioni della prostata

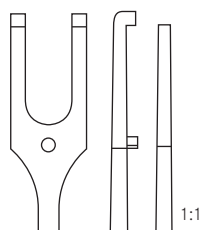

MILLIN

240 mm – 9½" **tk 30324-24**

Fadenführungszange
Ligatur carrying forceps

Pince porte-fil
Pinza porta-ligaduras
Pinza per fili di sutura

1:2



YOUNG

205 mm – 8" **tk 30310-20**

Prostata-Fasszange
Prostate holding forceps

Pince pour saisir la prostate
Pinza para coger la próstata
Pinza da presa per lobo prostatico

1:2

Blasenwundspreizer
Bladder retractors

Ecarteurs vésicaux
Separadores vesicales
Divaricatori vescicali



THOMSON-WALKER

tk 30335-00

komplett mit 2 Paar Seitenvalven, 1 Mittelvalve
complete with 2 pairs of lateral blades, 1 central blade
complet, avec 2 paires de valves latérales, 1 valve centrale
completo con 2 pares de valvas laterales, 1 valva central
completo, con 2 paia di valve laterali, 1 valva centrale



MILLIN

		57 mm x 25 mm	80 mm x 25 mm	120 mm x 45 mm
tk 30352-00	tk 30352-10	tk 30352-11	tk 30352-12	tk 30352-13
komplett <i>complete</i>	Sperrer, allein <i>Spreader, only</i>	2 Blätter <i>2 Blades</i>	2 Blätter <i>2 Blades</i>	1 Mittelblatt <i>1 Center blade</i>
complét <i>completa</i>	Retracteur, seul <i>Retracteur, solo</i>	2 Valves <i>2 Valvas</i>	2 Valves <i>2 Valvas</i>	1 Valve centrale <i>1 Valva central</i>
completa	Divaricatore, solo	2 Valve	2 Valve	1 Valva centrale

tk 30352-01

komplett mit Kaltlichtaufsatz
complete with cold light carrier
complét avec guide de lumière froide
completa con guía de luz fría
completa con portaluze fredda

tk 30352-02

Kaltlichtaufsatz
Cold light carrier

Guide de lumière froide
Guía de luz fría
Porta luce fredda, solo

Blasenwundspreizer
Bladder retractors

Ecarteurs vésicaux
Separadores vesicales
Divaricatori vescicali



LEGUEU
tk 30336-00

1:3

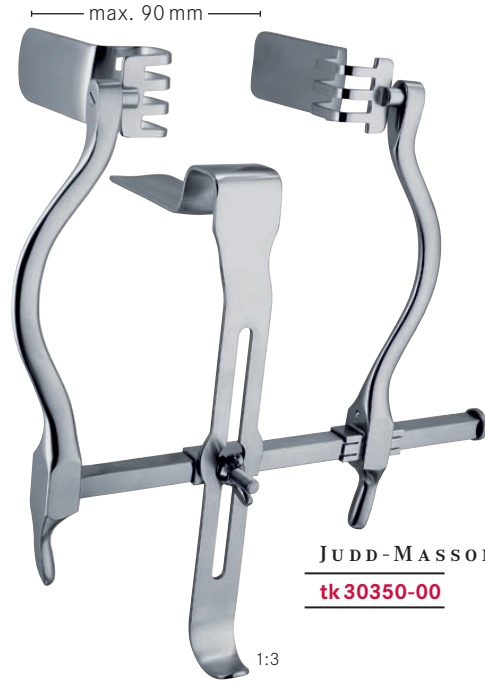

JUDD-MASSON
tk 30350-00

1:3



LEGUEU

1:3

	x = 35 mm
270 mm – 10 ³ / ₄ "	tk 30361-27



KOCHER

1:3

	x = 67 mm
260 mm – 10 ¹ / ₄ "	tk 30363-26

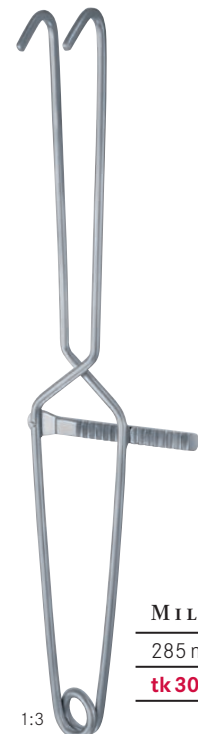

MILLIN

1:3

	285 mm – 11 ¹ / ₄ "
	tk 30331-00

Dilatationsbougies
Dilating bougies

Bougies dilatatrices
Bujías dilatadoras
Candelette dilatatrici

DITTEL

		220 mm–8¾"
2⅓ mm Ø	8 Charr./Fr.	tk 30390-08
3 mm Ø	9 Charr./Fr.	tk 30390-09
3⅓ mm Ø	10 Charr./Fr.	tk 30390-10
3½ mm Ø	11 Charr./Fr.	tk 30390-11
4 mm Ø	12 Charr./Fr.	tk 30390-12
4⅓ mm Ø	13 Charr./Fr.	tk 30390-13
4½ mm Ø	14 Charr./Fr.	tk 30390-14
5 mm Ø	15 Charr./Fr.	tk 30390-15
5⅓ mm Ø	16 Charr./Fr.	tk 30390-16
5½ mm Ø	17 Charr./Fr.	tk 30390-17
6 mm Ø	18 Charr./Fr.	tk 30390-18
6⅓ mm Ø	19 Charr./Fr.	tk 30390-19
6½ mm Ø	20 Charr./Fr.	tk 30390-20
7 mm Ø	21 Charr./Fr.	tk 30390-21
7⅓ mm Ø	22 Charr./Fr.	tk 30390-22
7½ mm Ø	23 Charr./Fr.	tk 30390-23
8 mm Ø	24 Charr./Fr.	tk 30390-24
8⅓ mm Ø	25 Charr./Fr.	tk 30390-25
8½ mm Ø	26 Charr./Fr.	tk 30390-26
9 mm Ø	27 Charr./Fr.	tk 30390-27
9⅓ mm Ø	28 Charr./Fr.	tk 30390-28
9½ mm Ø	29 Charr./Fr.	tk 30390-29
10 mm Ø	30 Charr./Fr.	tk 30390-30
10⅓ mm Ø	32 Charr./Fr.	tk 30390-32
11 mm Ø	33 Charr./Fr.	tk 30390-33
11⅓ mm Ø	34 Charr./Fr.	tk 30390-34
12 mm Ø	36 Charr./Fr.	tk 30390-36

1:2



gerade
straight
droit
recta
rette

DITTEL

		350 mm–13¾"
2⅓ mm Ø	8 Charr./Fr.	tk 30392-08
3 mm Ø	9 Charr./Fr.	tk 30392-09
3⅓ mm Ø	10 Charr./Fr.	tk 30392-10
3½ mm Ø	11 Charr./Fr.	tk 30392-11
4 mm Ø	12 Charr./Fr.	tk 30392-12
4⅓ mm Ø	13 Charr./Fr.	tk 30392-13
4½ mm Ø	14 Charr./Fr.	tk 30392-14
5 mm Ø	15 Charr./Fr.	tk 30392-15
5⅓ mm Ø	16 Charr./Fr.	tk 30392-16
5½ mm Ø	17 Charr./Fr.	tk 30392-17
6 mm Ø	18 Charr./Fr.	tk 30392-18
6⅓ mm Ø	19 Charr./Fr.	tk 30392-19
6½ mm Ø	20 Charr./Fr.	tk 30392-20
7 mm Ø	21 Charr./Fr.	tk 30392-21
7⅓ mm Ø	22 Charr./Fr.	tk 30392-22
7½ mm Ø	23 Charr./Fr.	tk 30392-23
8 mm Ø	24 Charr./Fr.	tk 30392-24
8⅓ mm Ø	25 Charr./Fr.	tk 30392-25
8½ mm Ø	26 Charr./Fr.	tk 30392-26
9 mm Ø	27 Charr./Fr.	tk 30392-27
9⅓ mm Ø	28 Charr./Fr.	tk 30392-28
9½ mm Ø	29 Charr./Fr.	tk 30392-29
10 mm Ø	30 Charr./Fr.	tk 30392-30
10⅓ mm Ø	32 Charr./Fr.	tk 30392-32
11 mm Ø	33 Charr./Fr.	tk 30392-33
11⅓ mm Ø	34 Charr./Fr.	tk 30392-34
12 mm Ø	36 Charr./Fr.	tk 30392-36

1:2



gebogen
curved
courbe
curva
curve

Dilationsbougies | **Bougies dilatatrices**
Dilating bougies | **Bujías dilatadoras**
Candelette dilatatrici



VAN BUREN

2 2/3 mm Ø	8 Charr./Fr.	tk 30391-08
3 1/3 mm Ø	10 Charr./Fr.	tk 30391-10
4 mm Ø	12 Charr./Fr.	tk 30391-12
4 2/3 mm Ø	14 Charr./Fr.	tk 30391-14
5 1/3 mm Ø	16 Charr./Fr.	tk 30391-16
6 mm Ø	18 Charr./Fr.	tk 30391-18
6 2/3 mm Ø	20 Charr./Fr.	tk 30391-20
7 1/3 mm Ø	22 Charr./Fr.	tk 30391-22
8 mm Ø	24 Charr./Fr.	tk 30391-24
8 2/3 mm Ø	26 Charr./Fr.	tk 30391-26
9 1/3 mm Ø	28 Charr./Fr.	tk 30391-28
10 mm Ø	30 Charr./Fr.	tk 30391-30
10 2/3 mm Ø	32 Charr./Fr.	tk 30391-32
11 1/3 mm Ø	34 Charr./Fr.	tk 30391-34
12 mm Ø	36 Charr./Fr.	tk 30391-36

VAN BUREN
tk 30391-00

Satz, Fig. 08 – Fig. 36
 Set, Fig. 08 – Fig. 36

Jeu, Fig. 08 – Fig. 36
 Juego, Fig. 08 – Fig. 36
 Serie, Fig. 08 – Fig. 36



GUYON

3 1/3 mm Ø	10 Charr./Fr.	tk 30393-10
3 2/3 mm Ø	11 Charr./Fr.	tk 30393-11
4 mm Ø	12 Charr./Fr.	tk 30393-12
4 1/3 mm Ø	13 Charr./Fr.	tk 30393-13
4 2/3 mm Ø	14 Charr./Fr.	tk 30393-14
5 mm Ø	15 Charr./Fr.	tk 30393-15
5 1/3 mm Ø	16 Charr./Fr.	tk 30393-16
5 2/3 mm Ø	17 Charr./Fr.	tk 30393-17
6 mm Ø	18 Charr./Fr.	tk 30393-18
6 1/3 mm Ø	19 Charr./Fr.	tk 30393-19
6 2/3 mm Ø	20 Charr./Fr.	tk 30393-20
7 mm Ø	21 Charr./Fr.	tk 30393-21
7 1/3 mm Ø	22 Charr./Fr.	tk 30393-22
7 2/3 mm Ø	23 Charr./Fr.	tk 30393-23
8 mm Ø	24 Charr./Fr.	tk 30393-24
8 1/3 mm Ø	25 Charr./Fr.	tk 30393-25
8 2/3 mm Ø	26 Charr./Fr.	tk 30393-26
9 mm Ø	27 Charr./Fr.	tk 30393-27
9 1/3 mm Ø	28 Charr./Fr.	tk 30393-28
9 2/3 mm Ø	29 Charr./Fr.	tk 30393-29
10 mm Ø	30 Charr./Fr.	tk 30393-30

GUYON
tk 30393-00

Satz, Fig. 10 – Fig. 30, ohne Innengewinde
 Set, Fig. 10 – Fig. 30, without inner thread

Jeu, Fig. 10 – Fig. 30, sans filet intérieur
 Juego, Fig. 10 – Fig. 30, sin filete interior
 Serie, Fig. 10 – Fig. 30, senza filetto interno

Metallkatheter für Frauen
Metal catheters for women

Sondes métalliques pour femmes
 Sondas metálicas para mujeres
 Sonde metalliche per donne



GUYON

2 mm Ø	6 Charr./Fr.	tk 30410-06
2 1/3 mm Ø	7 Charr./Fr.	tk 30410-07
2 2/3 mm Ø	8 Charr./Fr.	tk 30410-08
3 mm Ø	9 Charr./Fr.	tk 30410-09
3 1/3 mm Ø	10 Charr./Fr.	tk 30410-10
3 2/3 mm Ø	11 Charr./Fr.	tk 30410-11
4 mm Ø	12 Charr./Fr.	tk 30410-12
4 1/3 mm Ø	13 Charr./Fr.	tk 30410-13
4 2/3 mm Ø	14 Charr./Fr.	tk 30410-14
5 mm Ø	15 Charr./Fr.	tk 30410-15
5 1/3 mm Ø	16 Charr./Fr.	tk 30410-16
5 2/3 mm Ø	17 Charr./Fr.	tk 30410-17
6 mm Ø	18 Charr./Fr.	tk 30410-18
6 1/3 mm Ø	19 Charr./Fr.	tk 30410-19
6 2/3 mm Ø	20 Charr./Fr.	tk 30410-20
7 mm Ø	21 Charr./Fr.	tk 30410-21
7 1/3 mm Ø	22 Charr./Fr.	tk 30410-22
7 2/3 mm Ø	23 Charr./Fr.	tk 30410-23
8 mm Ø	24 Charr./Fr.	tk 30410-24

Dilationsbougies
Dilating bougies

Bougies dilatatrices
Bujías dilatadoras
Candelette dilatatrici

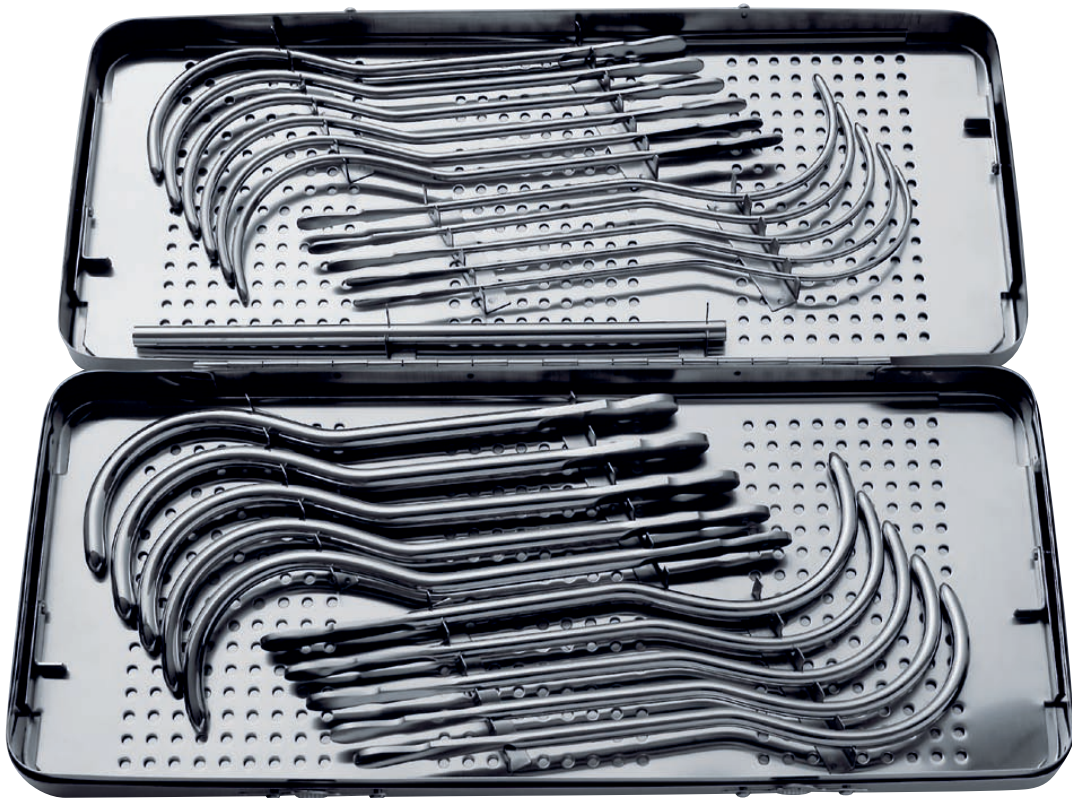

GUYON

420 mm x 175 mm x 40 mm

tk 30398-00

komplett, Charr. 10 – 30, im Edelstahl-Etui
complete, Charr. 10 – 30, in steel case

complet, Charr. 10 – 30, en étui métallique

completa, Charr. 10 – 30, en caja metalica

completa, Charr. 10 – 30, in astuccio metallico

Urethrotom | Urétrotome
 Urethrotome | Uretrótomo
 Uretrotomi



OTIS

tk30423-00

komplett, im Holzetui
 mit Dilatator, 2 Messern und 3 Ansätzen
*complete in wooden case
 with dilator, 2 knives and 3 tips*
 complet, en boîte de bois
 avec dilateur, 2 lames et 3 embouts
*completo en caja de madera
 con dilatador, 2 cuchillos y 3 puntas*
 completo, in contenitore di legno
 con dilatatore, 2 bisturi e 3 punte

tk 30424-00

Ersatzmesser
Spare blade
 Lame de rechange
Hoja de cambio
 Lama di ricambio



Urologie-Instrumente
Instruments for urology

Instruments pour l'urologie
Instrumentos para la urología
Strumenti per urologia

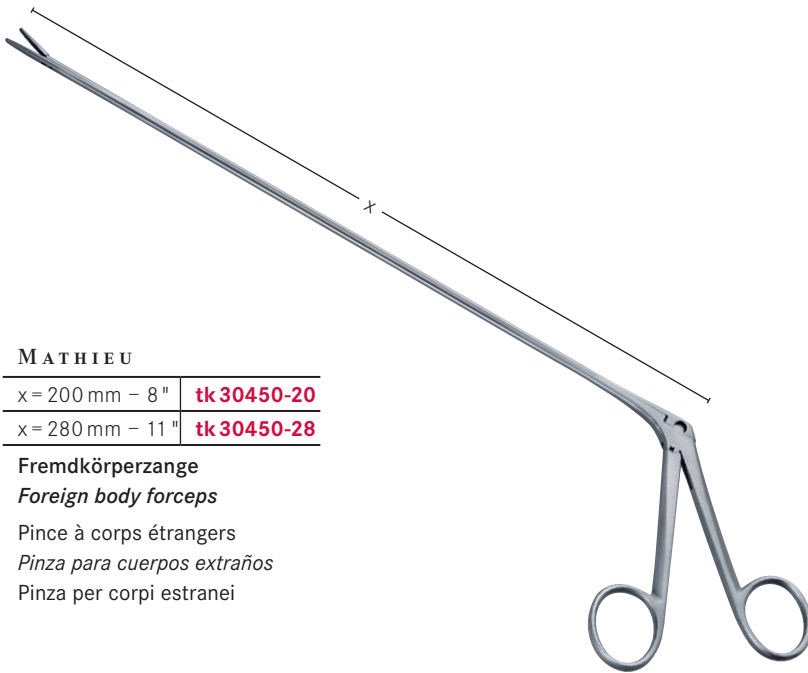

MATHIEU

x = 200 mm – 8"	tk 30450-20
x = 280 mm – 11"	tk 30450-28

Fremdkörperzange

Foreign body forceps

Pince à corps étrangers

Pinza para cuerpos extraños

Pinza per corpi estranei



1:2

160 mm – 6¼"	tk 17011-16
--------------	--------------------

Samenstrang-Haken

Hook for the spermatic cord

Crochet pour le cordon spermatique

Granchó para el cordón espermático

Uncino per dotto spermatico



GUYON

1:3

1:3

390 mm – 15½"

350 mm – 13¾"

tk 30444-39

tk 30445-35

Katheterspanner

Mandrin for rubber catheters

Mandrin pour cathéters

Mandril para catéteres

Introduttore per catheteri

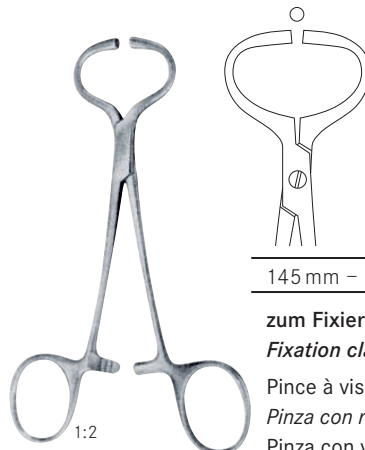

1:2

145 mm – 5¾"	tk 30467-14
--------------	--------------------

zum Fixieren des Samenstranges

Fixation clamp for the spermatic cord

Pince à vis pour fixation du cordon spermatique

Pinza con rosca para fijación el cordon espermático

Pinza con vite per fissare il funicolo spermatico

Beschneidungsinstrumente
Circumcision instruments

Instruments de circoncision
Instrumentos para circuncisión
Strumenti per circoncisione



8 mm Ø	tk 30456-08
11 mm Ø	tk 30456-11
13 mm Ø	tk 30456-13
16 mm Ø	tk 30456-16
21 mm Ø	tk 30456-21
26 mm Ø	tk 30456-26
32 mm Ø	tk 30456-32

Beschneidungsklemme
Circumcision instrument
Instrument de circoncision
Instrumento para circuncisión
Strumento di circoncisione



75 mm – 3"	tk 30458-00
------------	--------------------

Beschneidungsklemme
Circumcision instrument
Instrument de circoncision
Instrumento para circuncisión
Strumento di circoncisione

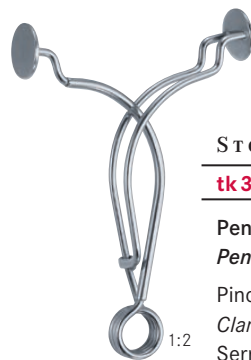

STOCKMANN
tk 30460-08

Penisklemme
Penis clamp
Pince pour le pénis
Clamp para el pene
Serrapene



STRAUSS
tk 30465-11

Penisklemme
Penis clamp
Pince pour le pénis
Clamp para el pene
Serrapene

