



Simply a smart choice. Simply your choice.



Trays and Containers



CleanLoop™

GEISTER®

STER. DAT.
STER. DATE
VERFALL. DAT.
EXP. DATE
STER. NR.
STER. NO.
NAME
DAMPF BRAUN
STEAM BROWN



CleanLoop™ Sterilization Box

completely filterless. Fast drying.

The innovative design of our new CleanLoop™ Sterilization Box and the optimized material properties ensure highest quality, safety and functionality. The covers are machined from a single aluminum block. Thus it is totally stiff and free from distortion and provides, together with „TOX® clinch“ connections at the joints of the parts and fittings, for absolute tightness and durability. The high quality material is non-adhesive, non-porous and free of corrosion and supports with its special alloy a quick and residue-free drying in steam sterilization. The solid and ergonomic stainless steel strap is riveted into the lid margin with a safety distance to the seal and can be closed with one hand.

The fully integrated barrier filter is milled into the lid and effectively traps with its „Pasteur“ labyrinth - consisting of ring ribs with a meandering flow path - microbes, particles and germs with an efficiency of 99.997%. The filterless system requires no consumables, securely stops microorganisms and can be re-sterilized without limitations. The labyrinth disc can be quickly installed with a simple bayonet lock. To open or close just push down the disc and turn.

For a unique identification of contents and storage handling the boxes are equipped with two slots for color or RFID chips, and with a slot for clearly laid protocol label or chemical indicator sheet (accessory). Standard lid color is red. 6 alternative colors are available.

All this makes the CleanLoop™ sterilization box a sustainable, responsible and stable value investment. Simply a smart choice, simply your choice.

Standards:

DIN EN ISO 11607 Part 1 und Part 2:2006,
 DIN EN 868 Part 8:1999, DIN 58953-9:2010-05,
 EN 285:2008, DIN EN ISO 17665 Part 1:2006,
 CE-mark acc. MDD 93/42 EWG.
 Approved for steam sterilization acc.
 EN 285 and validated acc. DIN EN ISO 17665-1.

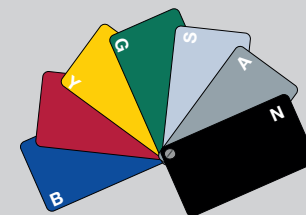

Locking clips can be sealed for added safety



Solid stainless steel carrying handles with 90° stop



Tox-Clinch connections; two dedicated spaces for color- or RFID-tags and a space for the indicator label



1/1 Type CleanLoop™ Sterilization Box



1/2 Type CleanLoop™ Sterilization Box

CleanLoop™ Sterilization Boxes



Available lid color coding

Red	77-7010 (standard=red)		
Blue	77-7010. B	Silver	77-7010. S
Yellow (gold)	77-7010. Y	Grey	77-7010. A
Green	77-7010. G	Black	77-7010. N



Mini Type CleanLoop™ Sterilization Box

1/1 Type

77-7010	Sterilization Box Aluminium	590x290x100 mm, Lid standard (red)
77-7011	Sterilization Box Aluminium	590x290x135 mm, Lid standard (red)
77-7012	Sterilization Box Aluminium	590x290x150 mm, Lid standard (red)
77-7013	Sterilization Box Aluminium	590x290x170 mm, Lid standard (red)
77-7015	Sterilization Box Aluminium	590x290x220 mm, Lid standard (red)
77-7017	Sterilization Box Aluminium	590x290x270 mm, Lid standard (red)

3/4 Type

77-7020	Sterilization Box Aluminium	460x290x100 mm, Lid standard (red)
77-7021	Sterilization Box Aluminium	460x290x135 mm, Lid standard (red)
77-7022	Sterilization Box Aluminium	460x290x150 mm, Lid standard (red)

1/2 Type

77-7030	Sterilization Box Aluminium	290x290x100 mm, Lid standard (red)
77-7031	Sterilization Box Aluminium	290x290x135 mm, Lid standard (red)
77-7032	Sterilization Box Aluminium	290x290x150 mm, Lid standard (red)
77-7033	Sterilization Box Aluminium	290x290x170 mm, Lid standard (red)
77-7035	Sterilization Box Aluminium	290x290x220 mm, Lid standard (red)
77-7037	Sterilization Box Aluminium	290x290x270 mm, Lid standard (red)

Mini Type

77-7050	Mini Sterilization Box Alu.	300x135x47 mm, Lid standard (red)
77-7052	Mini Sterilization Box Alu.	300x135x62 mm, Lid standard (red)
77-7053	Mini Sterilization Box Alu.	300x135x71 mm, Lid standard (red)



Opening or closing just takes a single action:
squeeze the filter cover, twist – that's it!



The sprung glass sphere at the centre locks the
push & turn mechanism.

CleanLoop™ Sterilization Box



77-7099 Promotional Trolley
590 x 290 x 150 mm, Lid with
GEISTER label (not for sterilization)

CleanLoop™ Sterilization Box

- Barrier filter with its Pasteur's swan-neck flask ensures efficient collection of bacteria, germs and particles. It can be used as often as required and causes no operating costs (no filter change). The labyrinth with circular ribs is permanently integrated into the lid. The labyrinth disc is mounted and locked by turning it into the bayonet locking. The disc can only be turned when it is pushed down slightly. The direction of rotation for opening/closing is engraved on the labyrinth disc.
- Distortion-free container lids manufactured through special production methods, render maximum stiffness possible. This ensures absolute leak-tightness. Lids machined from a single block of aluminium.



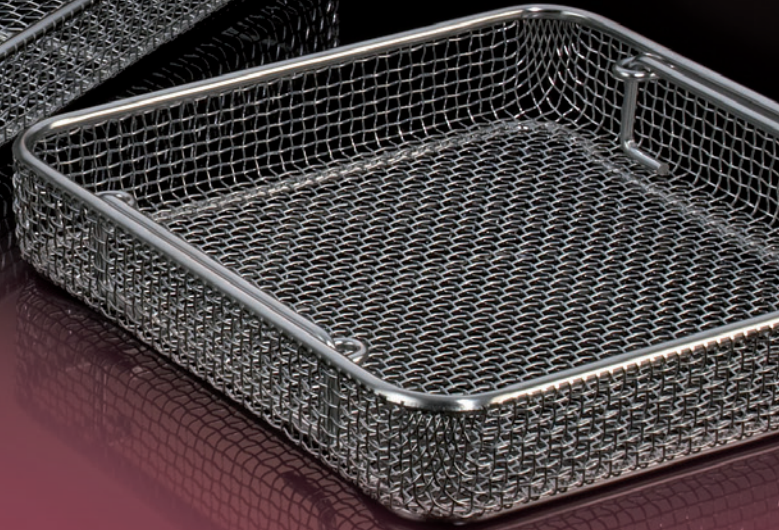
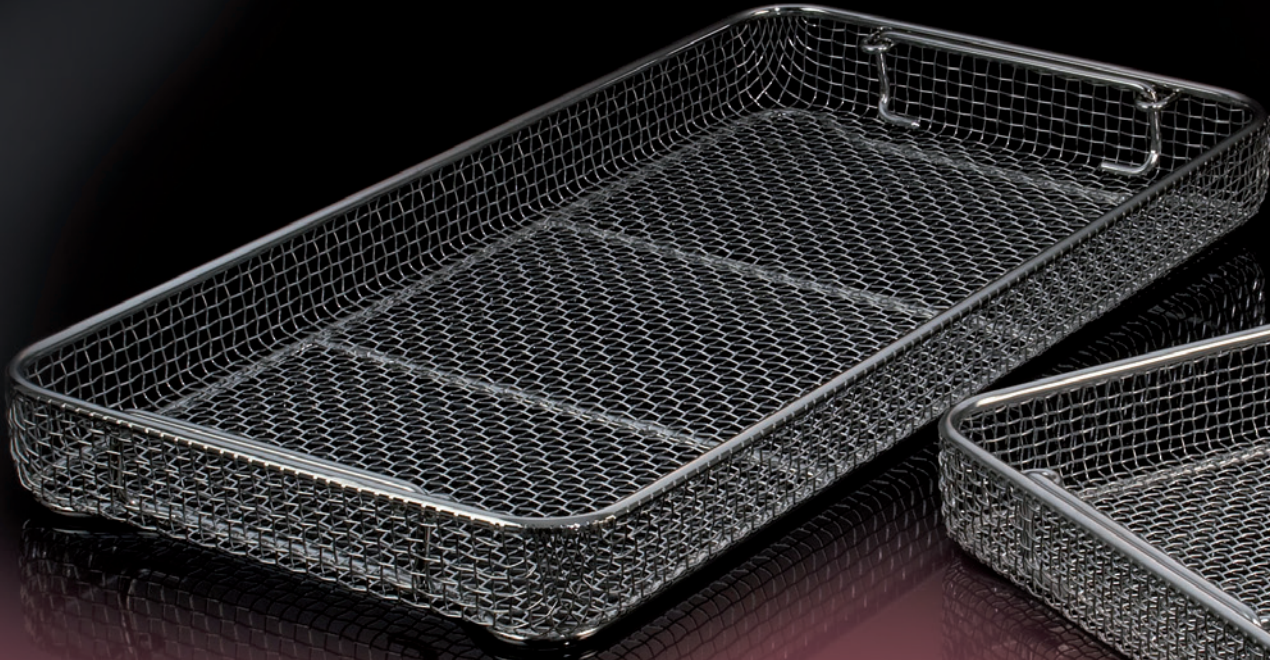

1/1 Type CleanLoop™ Tray

1/2 Type CleanLoop™ Tray



CleanLoop™ Wire-Mesh Trays

CleanLoop™ Perforated stainless steel trays w.handles

77-7211	1/1 Type, 485 x 255 x 30 mm
77-7212	1/1 Type, 485 x 255 x 50 mm
77-7213	1/1 Type, 485 x 255 x 70 mm
77-7214	1/1 Type, 485 x 255 x 100 mm
77-7215	1/1 Type, 540 x 255 x 50 mm for endoscopy

77-7221	3/4 Type, 405 x 255 x 30 mm
77-7222	3/4 Type, 405 x 255 x 50 mm
77-7223	3/4 Type, 405 x 255 x 70 mm
77-7224	3/4 Type, 405 x 255 x 100 mm

77-7231	1/2 Type, 255 x 245 x 30 mm
77-7232	1/2 Type, 255 x 245 x 50 mm
77-7233	1/2 Type, 255 x 245 x 70 mm
77-7234	1/2 Type, 255 x 245 x 100 mm

77-7251	Mini-Type, 260 x 115 x 25 mm
77-7252	Mini-Type, 260 x 115 x 45 mm

CleanLoop™ Silicone mats

77-7310	1/1 Type perforated, 440 x 230 mm, blue
77-7312	1/1 Type perforated, 520 x 230 mm, blue
77-7320	3/4 Type perforated, 380 x 230 mm, blue
77-7330	1/2 Type perforated, 220 x 230 mm, blue
77-7350	Mini-Type perforated, 270 x 125 mm, blue

Accessories

77-7101	Marking label Alu, with engraving, red
77-7102	Marking label Alu, with engraving, silver
77-7103	Marking label Alu, with engraving, blue
77-7104	Marking label Alu, with engraving, green
77-7105	Marking label Alu, with engraving, gold
77-7106	Marking label Alu, with engraving, black
77-7107	Marking label Alu, with engraving, grey
77-7111	Marking label Alu, without engraving, red
77-7112	Marking label Alu, without engraving, silver
77-7113	Marking label Alu, without engraving, blue
77-7114	Marking label Alu, without engraving, green
77-7115	Marking label Alu, without engraving, gold
77-7116	Marking label Alu, without engraving, black
77-7117	Marking label Alu, without engraving, grey
77-7120.R	Plugs with indicator, Pack.unit 100 pcs., red
77-7121.R	Plugs without indicator, Pack.unit, 100pcs, red
77-7125	Indicator labels for Mini Type, Pack.unit 100pcs
77-7126	Indicator labels, Pack.unit 1000pcs, for CleanLoop™box Type 1/1, 3/4 and 1/2

CleanLoop™ Silicone seals

77-7127.01	Type 1/1
77-7127.02	Type 3/4
77-7127.03	Type 1/2
77-7127.04	Mini-Type







Surgibox™ with permanent PTFE filters

Our new Surgibox™ economic standard sterilization container range complies with the standard EN868-8:2009 and AAMI ST77 and guarantees maximum user-friendliness and efficiency.

Each Surgibox™ is manufactured from a special, anodized aluminium alloy, that due to its high thermal conductivity, guarantees an optimum drying phase. Surgibox™ sterilization containers can be stacked to avoid space and storage problems. A silicone seal in the rim of the lid provides for a complete and leak-proof closure during and after sterilization. The filter holder, with an integrated silicone seal, ensures solid and firm germ-sealed positioning of the provided permanent PTFE filters with a maximum of 1200 cycles. The safety catch of this filter holder allows the longtime filters to be quickly and easily changed, if required.

The covering discs in the lids can be supplied in 6 different colors for easier identification. Surgibox™ sterilization containers can additionally be marked and tagged by the simple insertion of dedicated color or text labels into dedicated slots equipped with a safety spring. To prevent unauthorized opening, a safety seal can be fixed at the opening handle, which will break once the container is opened. Optionally your Surgibox™ could also be equipped with single use paper or polypropylene filters.

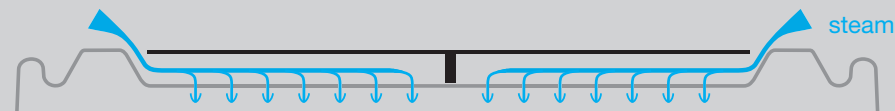

Optimal circulation

The perforated filter compartment in the lid is thoroughly protected against any impact by a robust protective cover disc in selectable colors. An optimum and barrier-free steam sterilization is still guaranteed.

Advantage

- ① Permanent PTFE filters with max. 1200 cycles prevent bacterial growth
- ② Lid handles for quick and hygienic lid removal
- ③ Improved locking mechanism
- ④ Convenient handling due to large handle with silicone gripping surface
- ⑤ Robust construction, 2 mm wall thickness

①

②

③

④

⑤



1/1 Type Surgibox™ 600 Sterilization Box



3/4 Type Surgibox™ 450 Sterilization Box

Surgibox™ Sterilization Boxes



1/2 Type Surgibox™ 300 Sterilization Box

Bottom, Aluminium**not perforated****Surgibox™ 600, 1/1 Type**

Art.-No.	Measure mm
76-3110.11	580 x 280 x 110
76-3110.16	580 x 280 x 160
76-3110.21	580 x 280 x 210
76-3110.26	580 x 280 x 260

Surgibox™ 450, 3/4 Type

76-3120.11	465 x 280 x 110
76-3120.16	465 x 280 x 160
76-3120.21	465 x 280 x 210

Surgibox™ 300, 1/2 Type

76-3130.11	285 x 280 x 110
76-3130.16	285 x 280 x 160
76-3130.21	285 x 280 x 210
76-3130.26	285 x 280 x 260

Bottom, Aluminium**perforated with 2 permanent filters****Surgibox™ 600, 1/1 Type**

Art.-No.	Measure mm
76-3210.11	580 x 280 x 110
76-3210.16	580 x 280 x 160
76-3210.21	580 x 280 x 210
76-3210.26	580 x 280 x 260

Bottom, Aluminium**perforated with 1 permanent filters****Surgibox™ 450, 3/4 Type**

76-3220.11	465 x 280 x 110
76-3220.16	465 x 280 x 160
76-3220.21	465 x 280 x 210

Surgibox™ 300, 1/2 Type

76-3230.11	285 x 280 x 110
76-3230.16	285 x 280 x 160
76-3230.21	285 x 280 x 210
76-3230.26	285 x 280 x 260

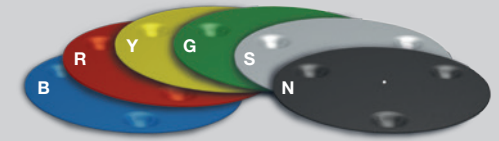
**Lid, Aluminium - with 2 permanent filters****Surgibox™ 600, 1/1 Type**

Art.-No.	Measure mm	Color
76-3310.R	580 x 280	red
76-3310.B	580 x 280	blue
76-3310.G	580 x 280	green
76-3310.N	580 x 280	black
76-3310.S	580 x 280	silver
76-3310.Y	580 x 280	gold (yellow)

Lid, Aluminium - with 1 permanent filter**Surgibox™ 450, 3/4 Type**

76-3320.R	465 x 280	red
76-3320.B	465 x 280	blue
76-3320.G	465 x 280	green
76-3320.N	465 x 280	black
76-3320.S	465 x 280	silver
76-3320.Y	465 x 280	gold (yellow)

Surgibox™ 300, 1/2 Type

76-3330.R	285 x 280	red
76-3330.B	285 x 280	blue
76-3330.G	285 x 280	green
76-3330.N	285 x 280	black
76-3330.S	285 x 280	silver
76-3330.Y	285 x 280	gold (yellow)

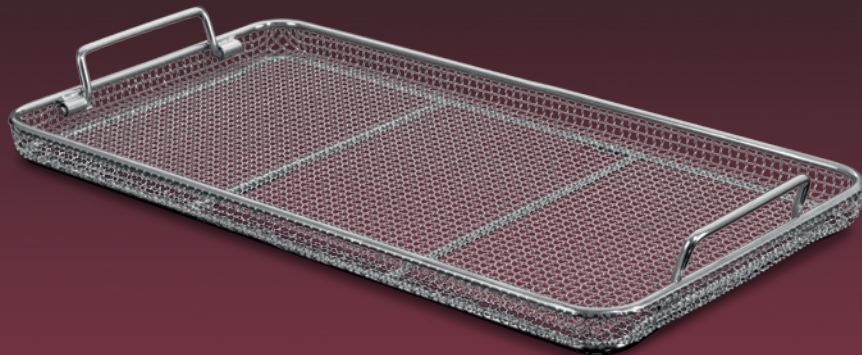

1/1 Type Tray

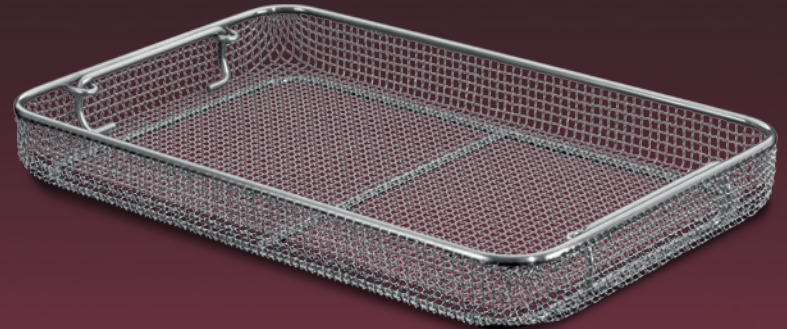

3/4 Type Tray

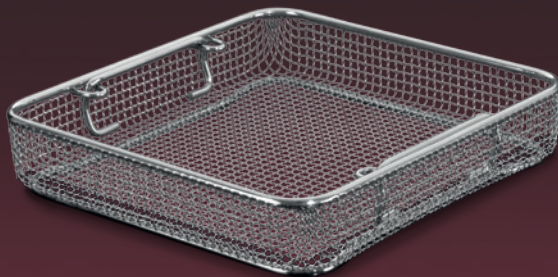

1/2 Type Tray

Wire Mesh Basket Trays with handles, stackable

Surgibox™ 600, 1/1 Type

Art.-No.	Measure mm
76-2113.05	510 x 254 x 50
76-2113.07	510 x 254 x 70
76-2113.10	510 x 254 x 100

Surgibox™ 450, 3/4 Type

76-2120.05	410 x 254 x 50
76-2120.07	410 x 254 x 70
76-2120.10	410 x 254 x 100

Surgibox™ 300, 1/2 Type

76-2130.05	240 x 254 x 50
76-2130.07	240 x 254 x 70
76-2130.10	240 x 254 x 100

Silicone mats, blue

Surgibox™ 600, 1/1 Type

Art.-No.	Measure mm
76-3001	440 x 230

Surgibox™ 450, 3/4 Type

76-3002	380 x 230
---------	-----------

Surgibox™ 300, 1/2 Type

76-3003	220 x 230
---------	-----------

Accessories for Surgibox™

Art.-No.	Description
76-3009	PTFE Permanent Filter, Ø 190mm, (up to 1200 cycles)
76-3020	Indicator Paper Labels, Pack of 100 pcs.
77-7120.R	Plugs with indicator, red, Pack of 100 pcs.
77-7121.R	Plugs without indicator, red, Pack of 100 pcs.

Silicone seals

Surgibox™ 600, 1/1 Type

Art.-No.
76-3019.10

Surgibox™ 450, 3/4 Type

76-3019.20

Surgibox™ 300, 1/2 Type

76-3019.30

Marking labels for Surgibox™

without engraving

Art.-No.	Color
76-3010.B	blue
76-3010.G	green
76-3010.N	black
76-3010.R	red
76-3010.S	silver
76-3010.Y	gold

with engraving

76-3011.B	blue
76-3011.G	green
76-3011.N	black
76-3011.R	red
76-3011.S	silver
76-3011.Y	gold

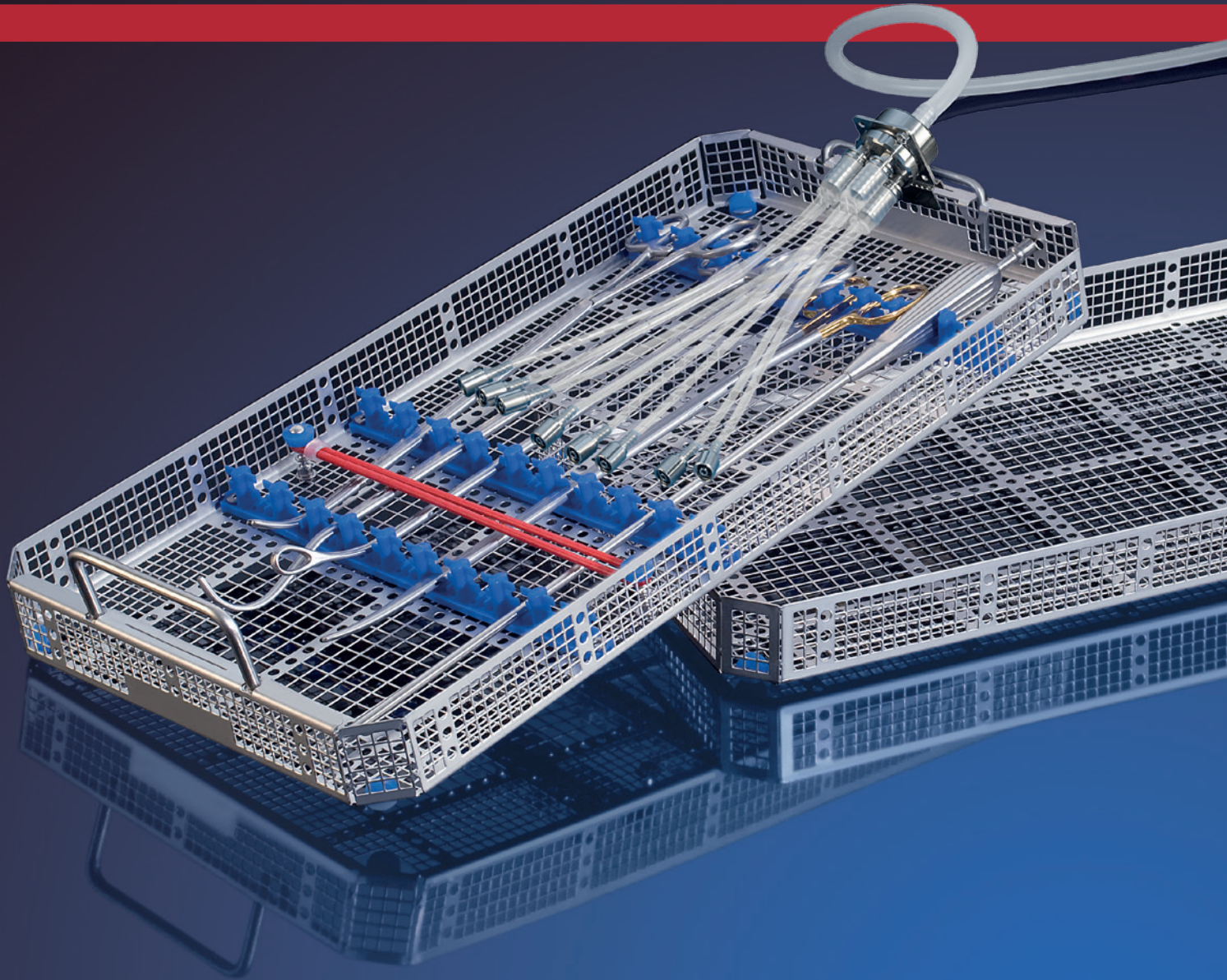



System Tray

The 3mach - system tray, new in our product portfolio, guarantees you a safe storage of your high quality instruments, both in a container or softpack-system.

The special structure and dimensions optimize the washing conditions. The unique design of the silicone cradles allows for excellent cleaning and drying with minimal contact surfaces. The sophisticated design saves space in the operating room and opens up completely new possibilities for the arrangement between the basket and lid. Try them!

A special highlight is the system tray with filter and rinse module, which was designed specifically for use of your washing machines in combination with ValveGate™*PRO* MICS instruments. The filtering of the detergent and the precise tuning of the irrigation pressure ensure a maximum cleaning and also prolong the service life of your instruments.

The innovative silicone cradles with their unique design provide for a secure hold, even in the container itself, avoiding the unwanted movement of the basket tray.

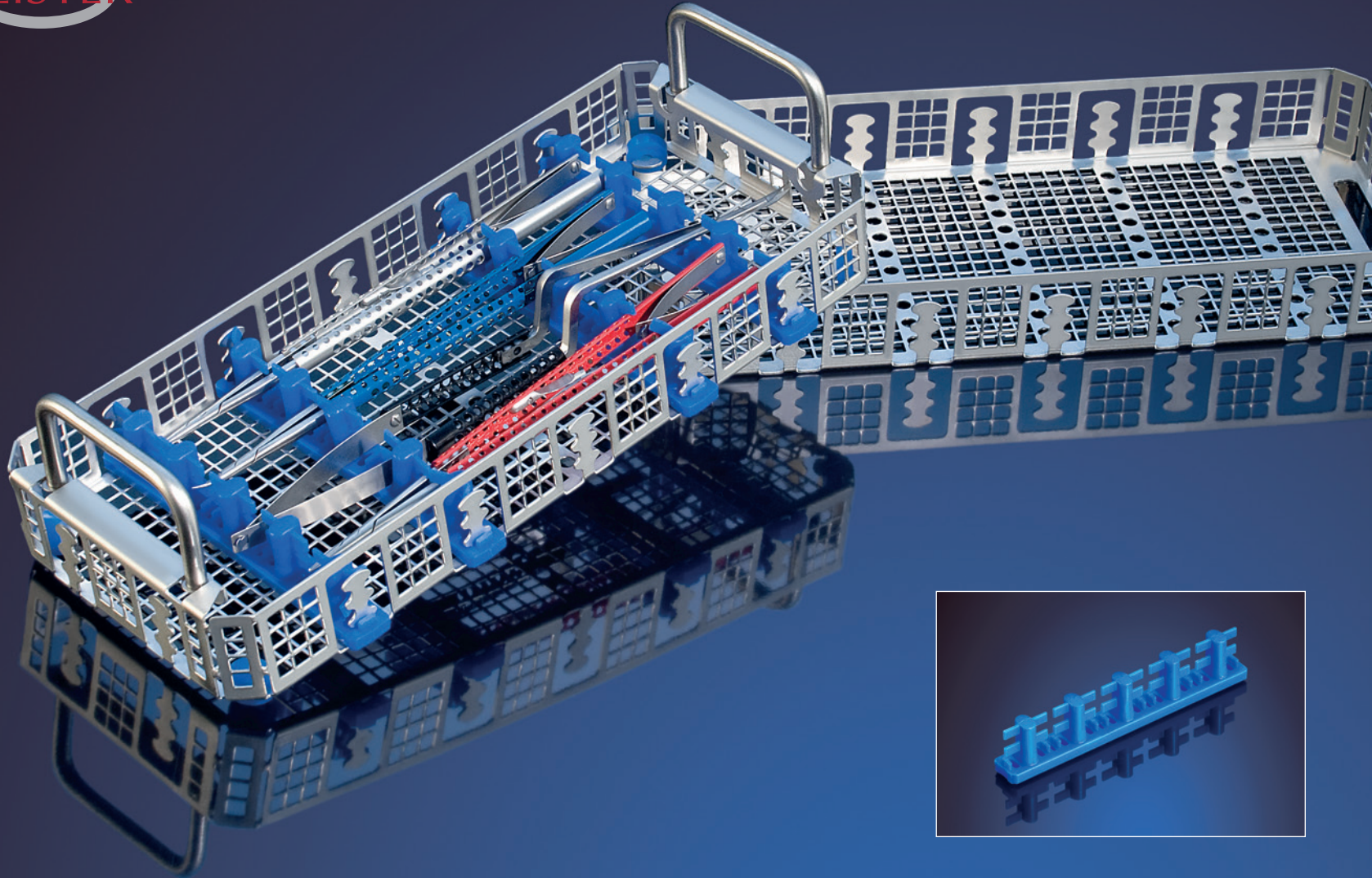

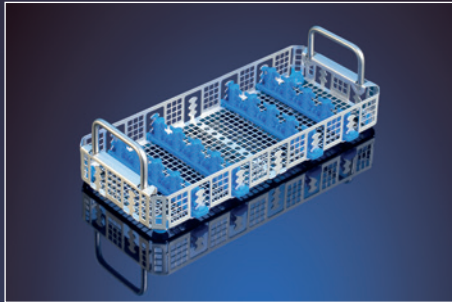

For secure washing and storage of up to 4 delicate microsurgical instruments

To ensure the functionality and long life of your microsurgical instruments, it is strongly recommended that they are placed in a special microsurgical instrument tray during machine washing, during sterilization and for storage. Large perforated finger mats provide maximum protection for instruments with prevention of metal on metal contact, maximum steam penetration and drainage during sterilization, as well as great flexibility in instrument placement.

77-3640 Small System Tray basket container
variable bracket and mounts
265 x 115 x 45 mm, with lid

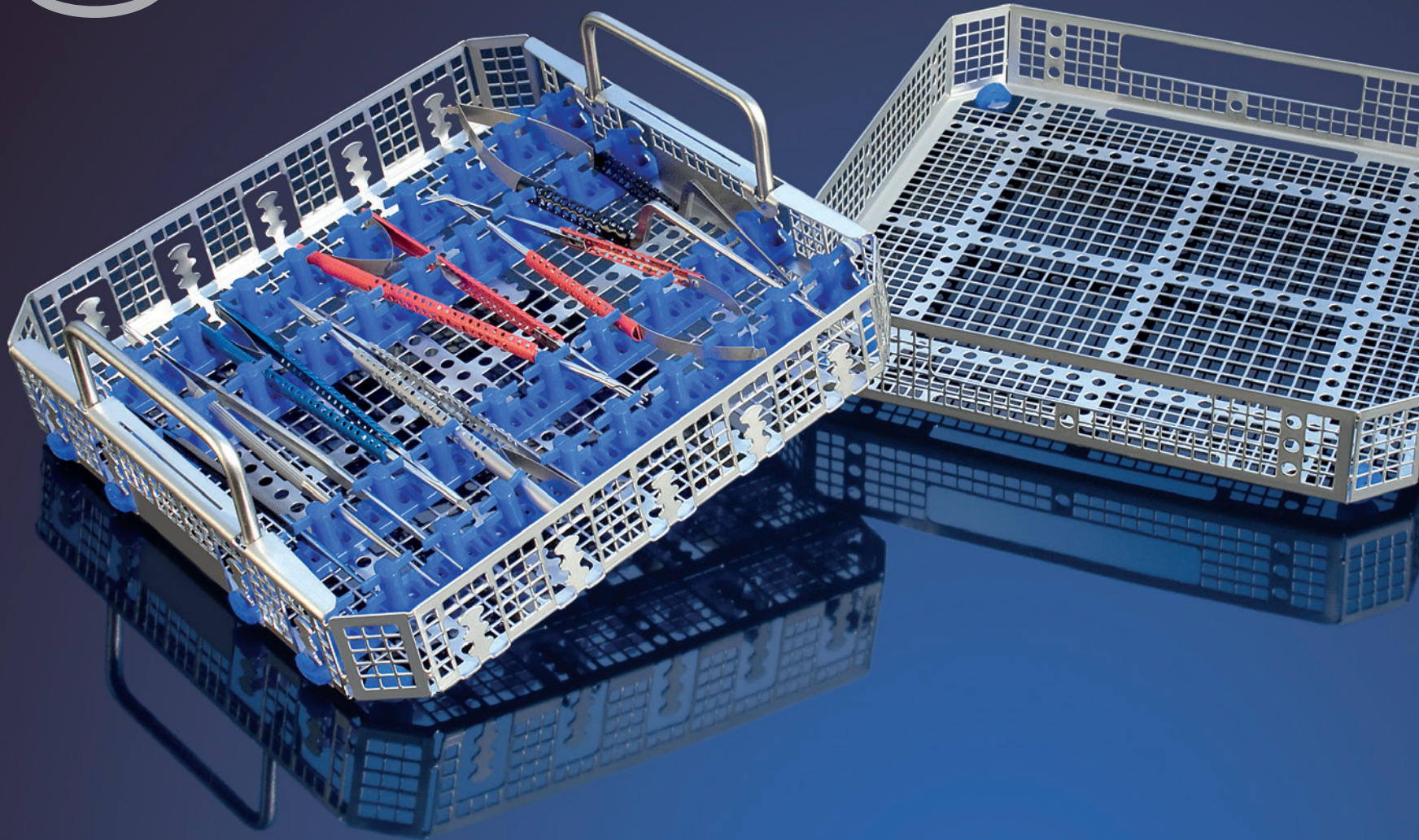

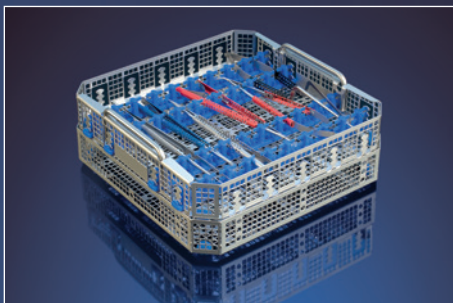
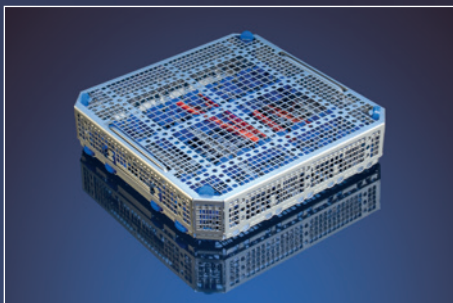
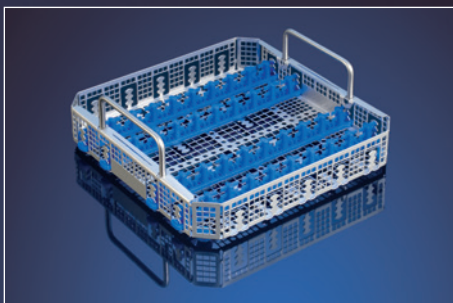

For secure washing and storage of up to 9 delicate microsurgical instruments

To ensure the functionality and long life of your microsurgical instruments, it is strongly recommended that they are placed in a special microsurgical instrument tray during machine washing, during sterilization and for storage. Large perforated finger mats provide maximum protection for instruments with prevention of metal on metal contact, maximum steam penetration and drainage during sterilization, as well as great flexibility in instrument placement.

77-3645 Medium System Tray basket container
variable bracket and mounts
240 x 240 x 45 mm, with lid

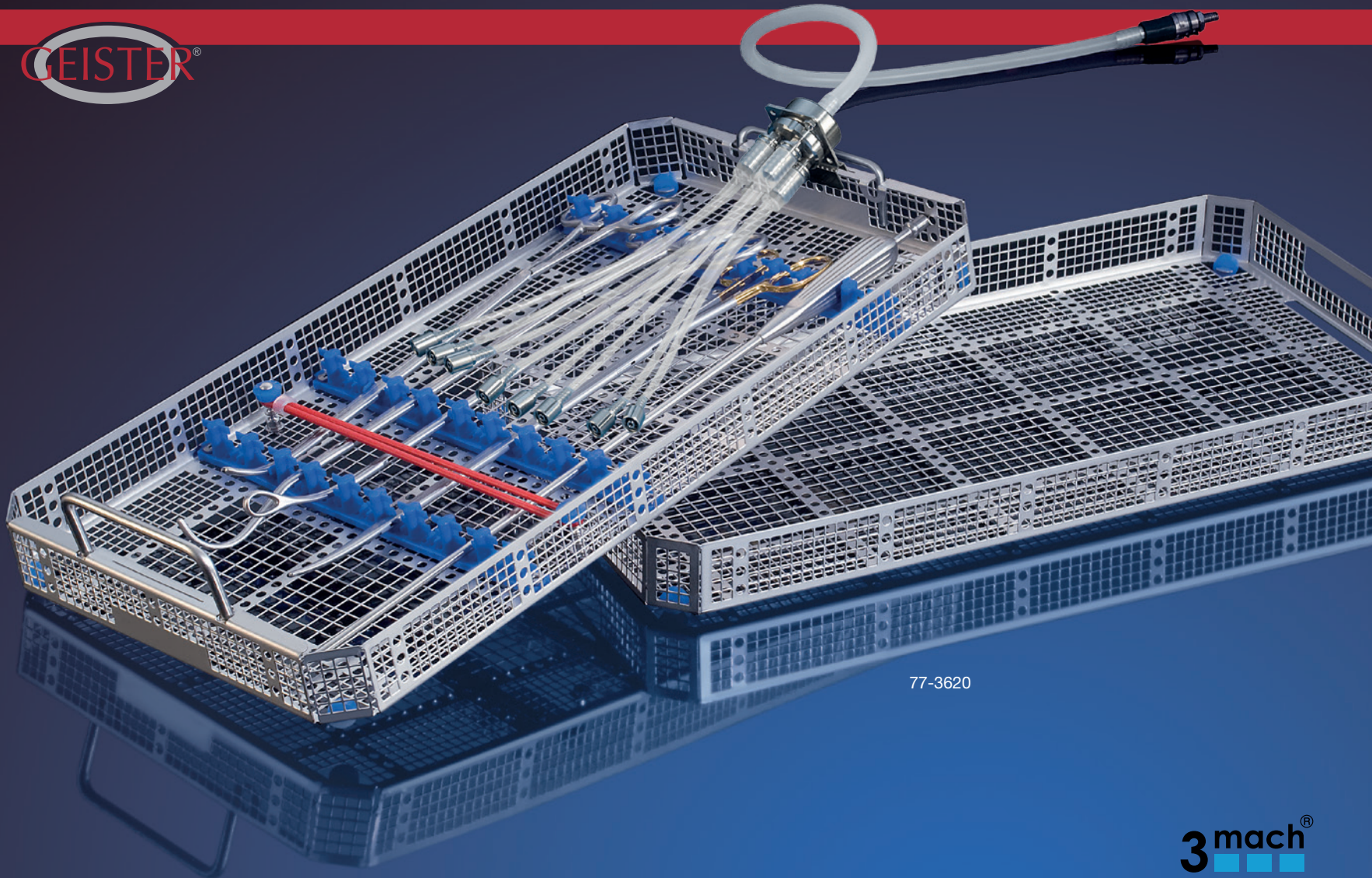

77-3620



System Trays

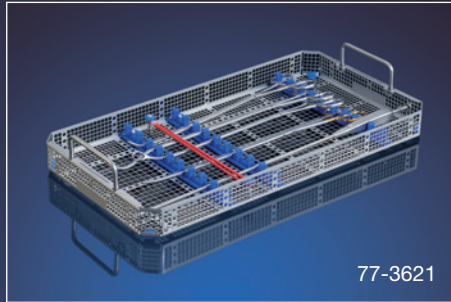

77-3621

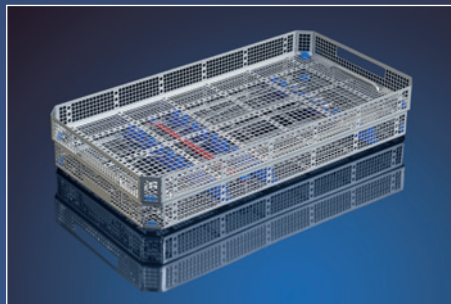

SURGIMOTOR™ Tray



14-6740.BO

System Tray with filter and rinse module, which was designed specifically for use of your washing machines in combination with ValveGate™ PRO MICS instruments. The filtering of the detergent and the precise tuning of the irrigation pressure ensure a maximum cleaning and also prolong the service life of your instruments.

The innovative silicone cradles with their unique design provide for a secure hold, even in the container itself, avoiding the unwanted movement of the basket tray.

77-3620 ValveGate™ PRO System Tray basket container with filter

Special Tray DIN with filter to connect 8 instruments
480 x 250 x 50 mm, with lid

77-3621 ValveGate™ PRO System Tray basket container

Special Tray DIN with variable bracket and mounts
484 x 254 x 45 mm, with lid

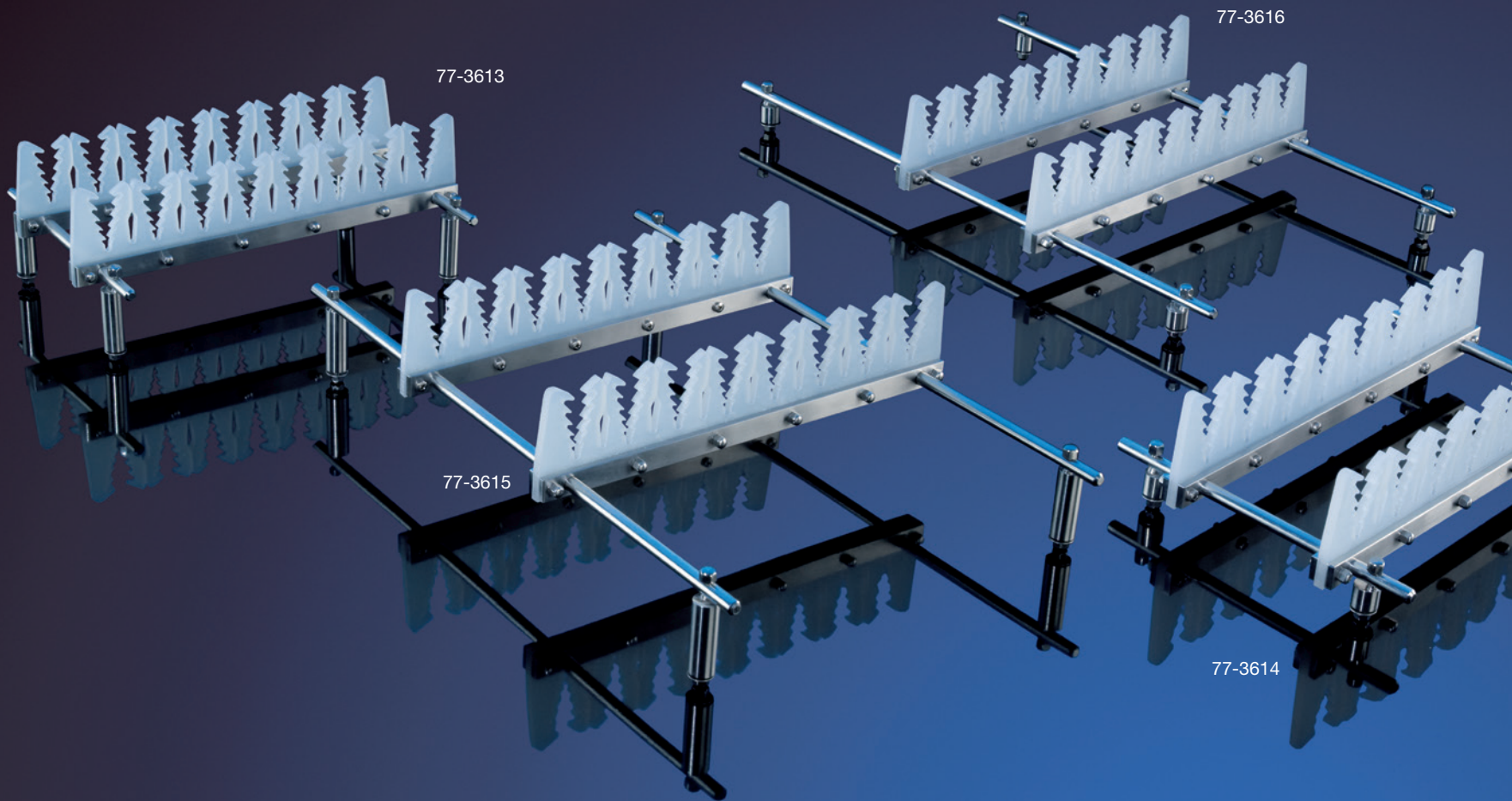

77-3613

77-3616

77-3615

77-3614



77-3611

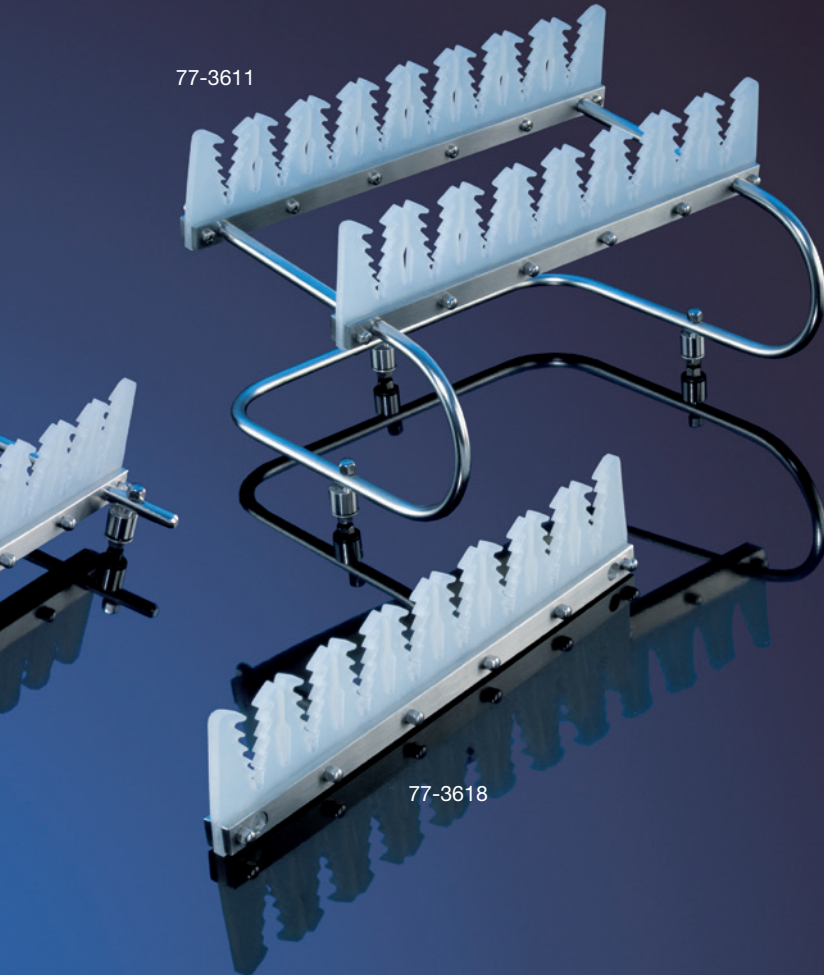

77-3618

Modular instrument tray system for installation in sterilization baskets

The different length and height of the rods and connecting components offer a great variety of combinations.

The silicon lips are interchangeable; customized lip design is also available.

The balks can be shifted easily along the rods.

The system components can be easily assembled with all screen baskets of most current brands with wire screen or perforated plate with the special eccentric holders.

The rack can be used in a horizontal position or space-saving in a vertical position.

Instrument Stands

77-3611	150 x 190 x 240 mm with tray screws
77-3612	150 x 190 x 240 mm without tray screws
77-3613	80 x 160 x 240 mm with tray screws
77-3614	25 x 160 x 240 mm with tray screws
77-3615	80 x 360 x 240 mm with tray screws
77-3616	25 x 360 x 240 mm with tray screws
77-3618	Silicone Cradle with Base 238mm
77-3619	Spare Part Set

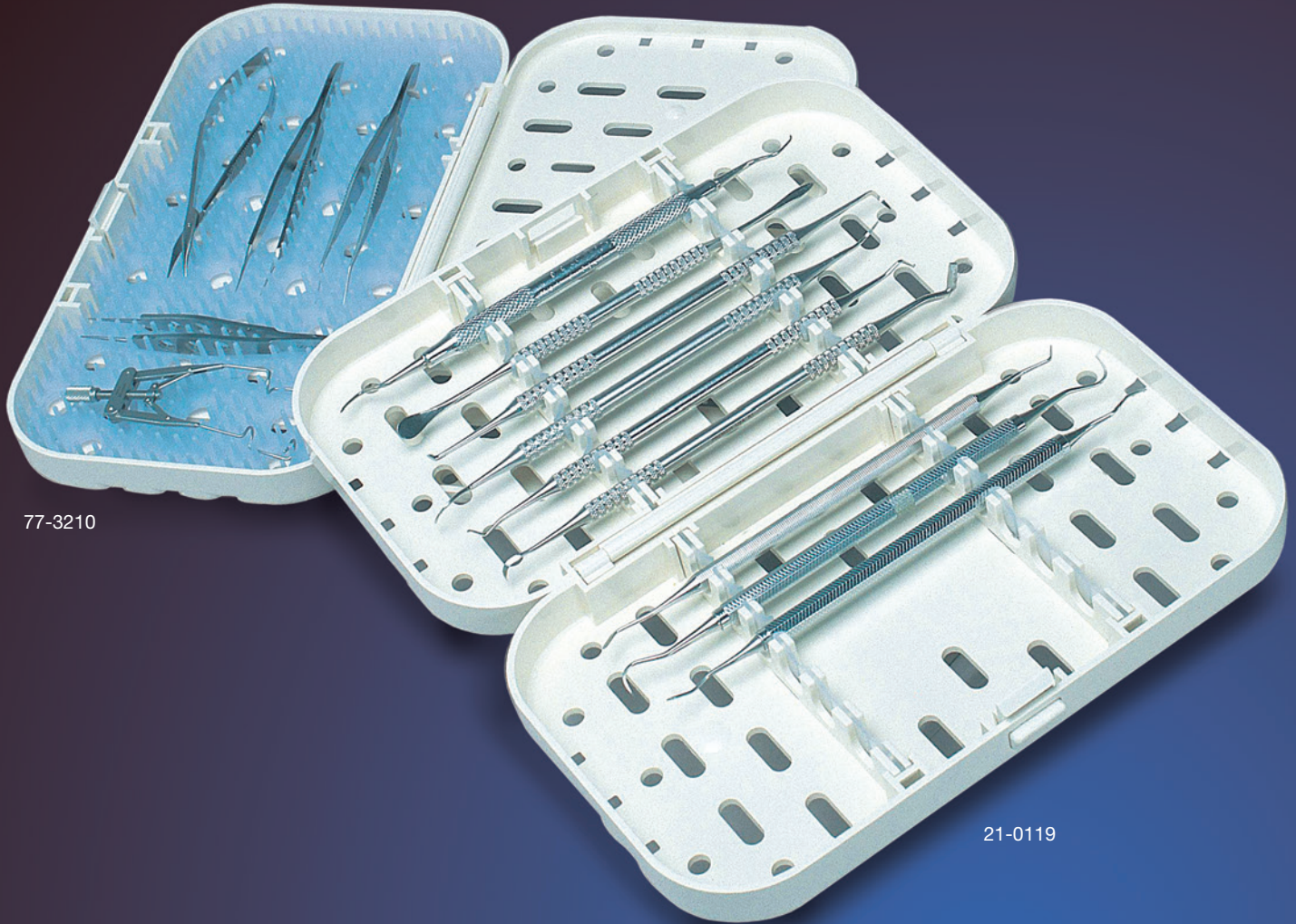

77-3210

21-0119



77-3210

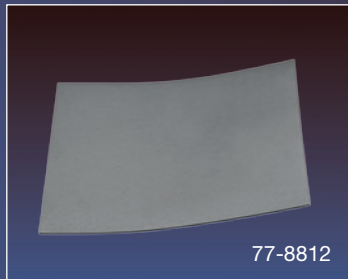

77-8812



77-8888

Plastic Instrument Cassettes

These economic, durable and multifunctional cassettes offer the ability to accommodate a wide array of delicate instruments.

They can be closed securely with a unique clip and hinge design. Silicone racks can accommodate instruments with diameters ranging from 2.5 to 8 mm.

Plastic Instrument Cassettes with lid

Art.-No.	Description	Dimensions mm
21-0118	6-Position slotted cassette for 6 instruments Ø 2.5–8 mm	203 x 114 x 15
21-0119	12-Position slotted cassette for 12 instruments Ø 2.5–8 mm	203 x 114 x 30
77-3210	Shallow instrument cassette with silicone mat	203 x 114 x 15
77-3230	Deep instrument cassette with silicone mat	203 x 114 x 30

Mats

Art.-No.	Description	Dimensions mm
77-8812	Magnetic Mat flexible, for organization and storage of small parts and needles	200 x 200 x 1,5
77-8888	Silicone magnetic mat, 18 magnetic inserts	330 x 230



77-3250

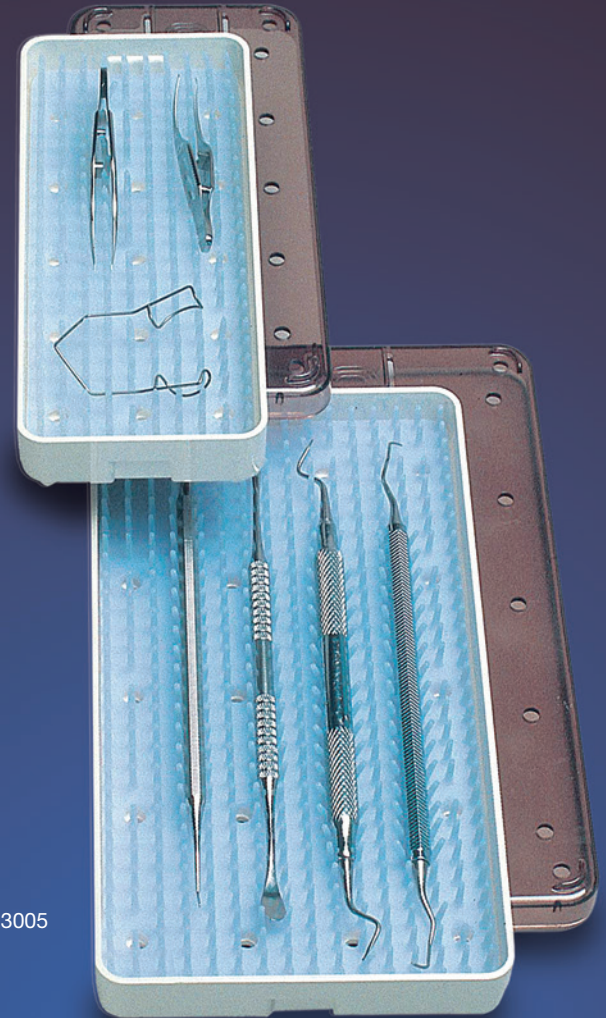

77-3005



Plastic Universal Trays

Designed to accommodate micro to medium sized instrumentation. These trays with their expanded capacity provide ample space to configure comprehensive procedural sets. Silicone mats allow for the efficient placement of instruments and the unique raised design helps to facilitate the sterilization process. Clear Radel®R lids allow for the easy identification of instruments.

Plastic Universal Trays with clear lid

Art.-No.	Description	Dimensions mm
77-3250	Large 11 x 14" tray with silicone mat (shallow)	298 x 368 x 19
77-3260	Large 10 x 18" tray with silicone mat (deep)	262 x 465 x 59
77-3270	Large 8 x 17" tray with silicone mat (shallow)	210 x 439 x 16
77-3280	Full size silicone mat (no holes)	483 x 356 x 17

Plastic Mini Containers

This line of small to medium sized trays has been specially designed to help organize and protect your mini to microsurgical instrumentation during sterilization, surgical presentation and storage. An array of sizes is available to customize procedural sets. Silicone mats allow for the efficient placement of instruments and the unique raised design helps to facilitate the sterilization process. Clear Radel®R lids allow for the easy identification of instruments.

Plastic Mini Containers

Art.-No.	Description	Dimensions mm
77-3005	Small 2 x 7" tray, lid and silicone mat	180 x 49 x 18.5
77-3030	Small 3 x 6" tray, lid and silicone mat	148 x 64 x 18.5
77-3040	Small 3 x 7" tray, lid and silicone mat	180 x 73 x 18.5
77-3070	Small 4 x 8" tray, lid and silicone mat	190 x 102 x 18.5
77-3010	Small 2 x 7" tray and lid with 2 silicone racks for 1 diamond knife	180 x 49 x 18.5
77-3020	Small 2 x 7" tray and lid with 2 silicone racks for 2 diamond knives	180 x 49 x 18.5
77-3050	Small 3 x 7" tray and lid with 2 silicone racks for 3 diamond knives	180 x 73 x 18.5
77-3060	Small 3 x 7" tray and lid with 2 silicone racks for 8 cannulae	180 x 73 x 18.5
77-3080	Medium 7 x 11" tray, lid and silicone mat (shallow)	270 x 160 x 16.0
77-3090	Medium 7 x 11" tray, lid and silicone mat (deep)	270 x 160 x 35.0
77-3100	Medium 7 x 11" tray, lid, insert tray and 2 silicone mats (double level)	270 x 160 x 35.0

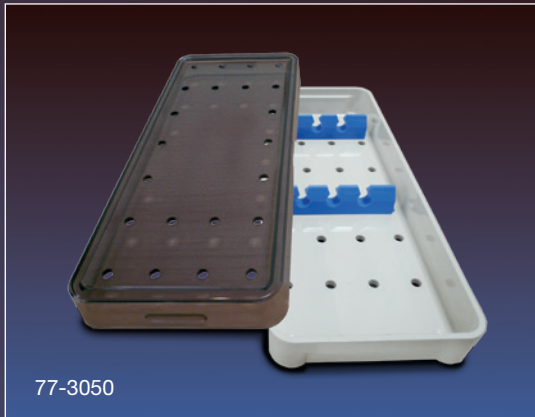

77-3050

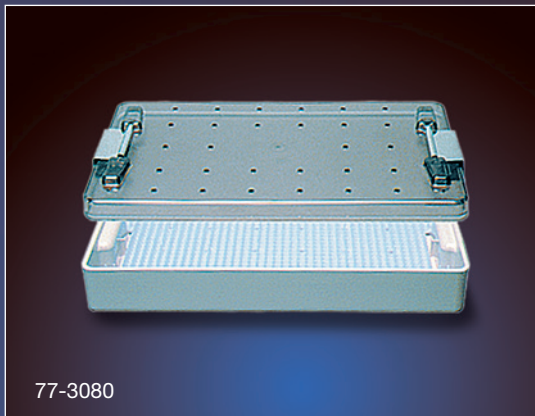

77-3080

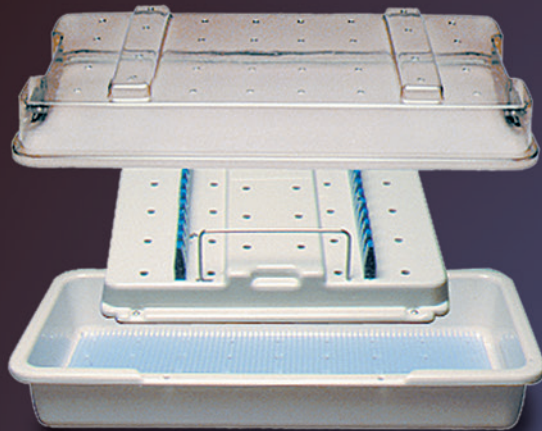

77-3600

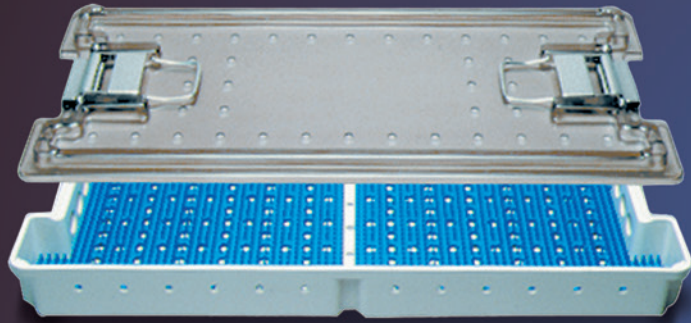

77-3420

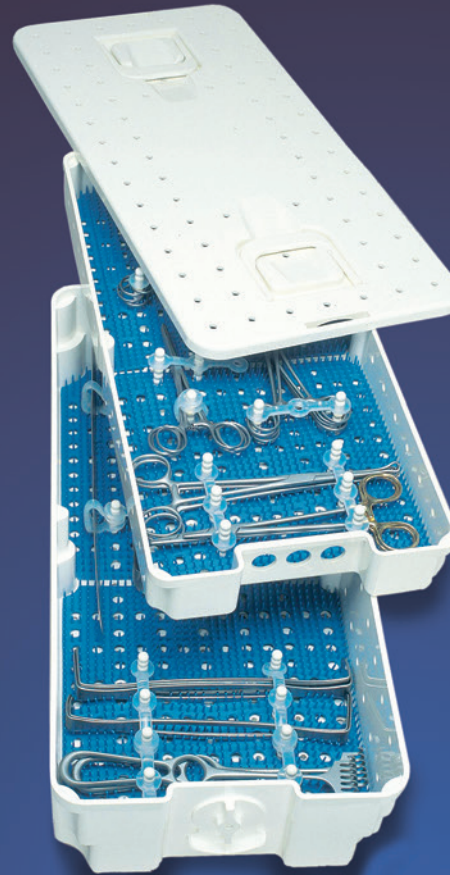

77-3400



77-3655

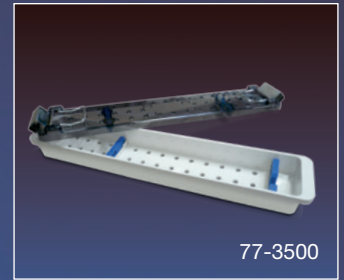

77-3500

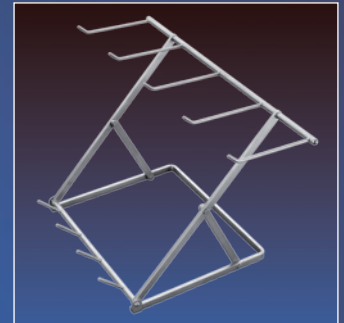

77-9300 Instrument Rack foldable



Plastic Speciality Containers

To accommodate a wide array of endoscopic and other hand-held instruments and endoscopes we have designed a range of speciality containers:

The convertible laparoscopy tray holds three sizes of laparoscopic instruments: 3 mm, 5 mm, and 10 mm. The tri-level silicone strips will accommodate up to 12 instruments. Instruments can also be placed in the full-size base with silicone mat.

The convertible hand held instrument tray (e.g. for spinal, neuro, arthroscopy or micro instruments) is designed with 4 silicone strips to accommodate a maximum of 16 hand-held instruments 4 mm in diameter. Additional instruments or scopes may be placed in the full-size base with silicone mat. The optional instrument stand holds up to 8 ring-handled microsurgical instruments in an upright position for easy access by the O.R. staff.

The scope tray is fitted with silicone strips designed to hold your delicate scopes in a secure and protective environment.

Plastic Speciality Containers

Art.-No.	Description	Dimensions mm
77-3600	Convertible ValveGate™ & Laparoscopy Base w. mat, removable insert, clear lid	478 x 203x130
77-3650	Hand Held Instrument Base, Insert and Lid,max.16 Instruments with Ø up to 4 mm,	464x190x70
77-3655	Stand for up to 8 ring handled instruments	225x118x36
77-3500	Single Scope Tray medium 1 scope 1-10 mm, max. 39 cm long	394x70x35

Modular Plastic Containers

Designed for large size instrument sets. Insert and base can be used together or separately with dedicated lids. Standard silicone cradles are available to help secure and organize the instruments. The flex system accessories provide the ability to place instruments in an organized procedural format. It includes posts and tie-downs to secure instruments and can be easily modified to accommodate change in layout.

Silicone mats are also available for the efficient placement of the instruments. Perforations allow for optimum steam penetration and drying. This economical, durable, functional and lightweight plastic container comes with a unique one-step positive latching system.

Modular Plastic Containers

Art.-No.	Description	Dimensions mm
77-3400	Plastic Container,double-level assembly 4"deep, consist of: Base 4", insert 2", 4 half mats, lid	502 x239 x 102
77-3410	Plastic Container,single-level assembly 4" deep, consist of: insert, 2 half mats and lid	502 x239 x 102
77-3420	Plastic Container,single-level assembly 2"deep, consist of: insert, 2 half mats, clear lid	464 x 229 x 51

Accessories for Modelar Plastic Containers

77-3430	Flex System snap-in post (pack of 12) for 77-3400 - 77-3420
77-3431	Flex System lateral silicone tie down, (pack of 12) for 77-3400 - 77-3420
77-3432	Flex System diagonal silicone tie down, (pack of 12) for 77-3400 - 77-3420
77-3433	Flex System silicone tie down combination pack (6 lateral and 6 diagonal)
77-3434	Flex System removal tool for assembled posts
77-9300	Instrument Rack foldable

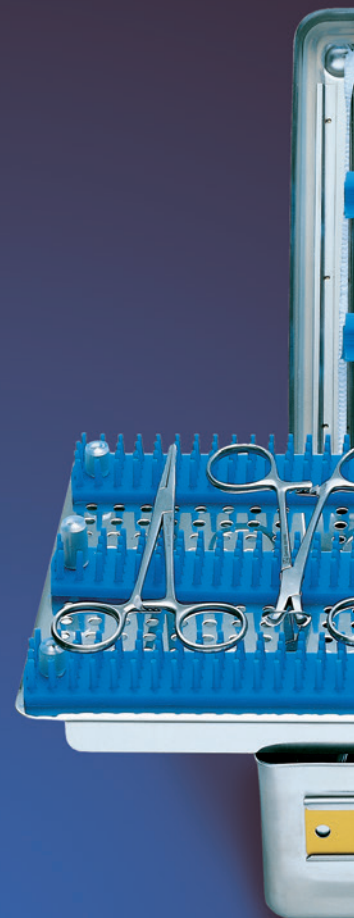



Sterilization Cases

stainless steel with silicone inserts

Stainless steel guarantees a solid, scratch- and wear-resistant exterior surface for long-term use. A silicone seal in the lid keeps germs away. Silicone cushioning strips, mats or racks in our instrument cases fix and protect the instruments and keep them in good condition and clean order. Interchangeable identification tags identify the case and distinguish its contents (choice of text and colours).

A maximum amount of instruments can be stored in a minimum of space. The cases are available with 1 or 2 levels in various dimensions. Silicone depressing bars at the inner side of the lid fix the position of the instruments underneath. The trays are easily removable from the container with heat-insulated knobs.

The 3 silicone strips can be replaced with a full silicone mat (option) if desired. Special configurations and trays are available on request. Models with a solid silicone rack can be adapted to your procedural sets with each instrument positioned on its defined place and optional laser-mark illustrations on the tray.

All instrument sterilization cases have a perforated base and lid for steam sterilization and are fitted with long-life textile filters, that must be replaced after max. 60 cycles.



77-0117 + 77-1207

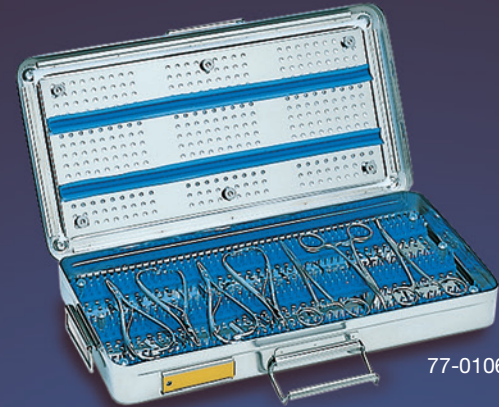

77-0106

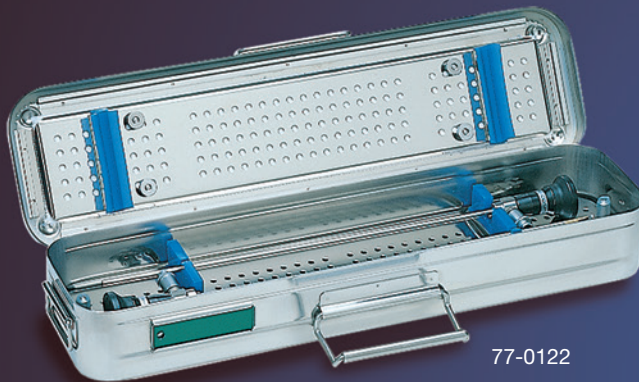

77-0122

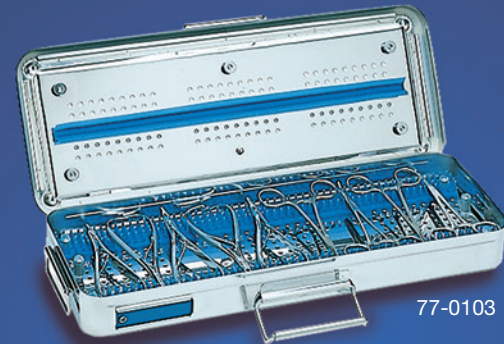

77-0103

Micro Instruments Containers



77-0105



77-0101

Micro Instruments Container, 1 level, with silicone racks (custom adapted on request), long-life filters

Container Dimensions mm	Art.-No. 1 level 65 mm	Art.-No. Textile Spare Filter
220 x 165	77-0121	77-0101.EF
420 x 125	77-0122	77-0102.EF
420 x 175	77-0123	77-0103.EF
300 x 220	77-0124	77-0104.EF
285 x 280	77-0125	77-0105.EF
410 x 225	77-0126	77-0106.EF
400 x 290	77-0127	77-0107.EF
450 x 260	77-0128	77-0108.EF
400 x 150	77-0129	77-0109.EF
495 x 270	77-0130	77-0110.EF

Accessories

Art.-No.	Description
77-1120	Metal Label, blue
77-1121	Metal Label, red
77-1122	Metal Label, green
77-1123	Metal Label, yellow
77-1128	Engraving one line for metal labels (specity text)
77-1129	Engraving two lines for metal labels (specity text)

Micro Instruments Container, 1 or 2 levels, long-life filters

Container Dimensions mm	Art.-No. 1 level 50 mm	Art.-No. 2 levels 75 mm	Silicone Mat Dimensions mm	Art.-No. Full Silicone Mat	Art.-No. Textile Spare Filter
220 x 165	77-0101	77-0111	195 x 135	77-1201	77-0101.EF
420 x 125	77-0102	77-0112	390 x 91	77-1202	77-0102.EF
420 x 175	77-0103	77-0113	392 x 144	77-1203	77-0103.EF
300 x 220	77-0104	77-0114	275 x 185	77-1204	77-0104.EF
285 x 280	77-0105	77-0115	255 x 245	77-1205	77-0105.EF
410 x 225	77-0106	77-0116	370 x 185	77-1206	77-0106.EF
400 x 290	77-0107	77-0117	365 x 252	77-1207	77-0107.EF
450 x 260	77-0108	77-0118	420 x 220	77-1208	77-0108.EF
400 x 150	77-0109	77-0119	374 x 120	77-1209	77-0109.EF
495 x 270	77-0110	77-0120	460 x 231	77-1210	77-0110.EF



GEISTER Medizintechnik GmbH

Föhrenstrasse 2 | D-78532 Tuttlingen | Germany

☎ +49 7461/966240 | 📠 +49 7461/9662422

www.geister.com | info@geister.com