



Magen, Darm  
*Stomach, Intestine*

Estomac, Intestins  
*Estómago, Intestino*  
Stomaco, Intestino





**Gewebe- und Darmfasszangen**  
**Tissue and intestinal holding forceps**

Pincers intestinales et de tissue  
Pinzas para tejidos y intestinos  
Pinze per tessuti ed intestinali



**ALLIS-BABY**

130 mm – 5" **tk28100-14**

Zähne 4x5  
Teeth

Dents  
Dientes  
Denti



**ALLIS**

150 mm – 6" **tk28140-15** **tk28160-15**

190 mm – 7½" **tk28160-19**

250 mm – 9¾" **tk28160-25**

Zähne 4x5 5x6  
Teeth  
Dents  
Dientes  
Denti



**ALLIS-ADAIR**

155 mm – 6" **tk28167-15**

Zähne 10x11  
Teeth

Dents  
Dientes  
Denti



**THOMS-ALLIS**

200 mm – 8" **tk28180-20**

6x7



**LOCKWOOD**

200 mm – 8" **tk28190-20**

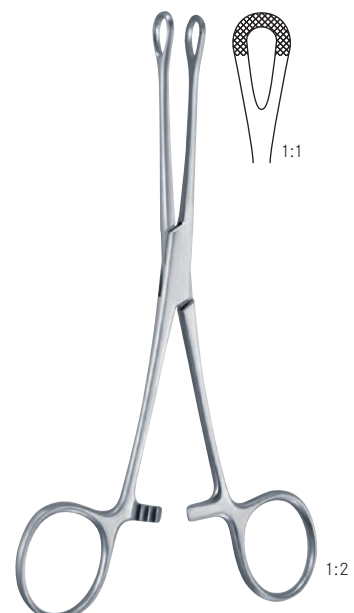

**WILLIAMS**

160 mm – 6¼" **tk28192-16**

Gewebe- und Darmfazzangen  
Tissue and intestinal holding forceps

Pinces intestinales et de tissue  
Pinzas para tejidos y intestinos  
Pinze per tessuti ed intestinali

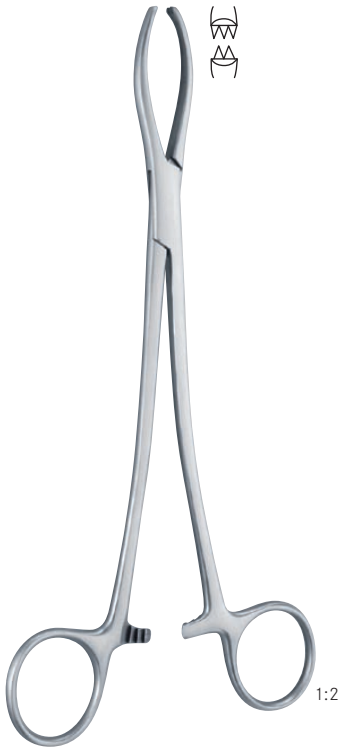

LITTLEWOOD

190 mm – 7½" tk 11955-19

Zähne 2x3

Teeth

Dents

Dientes

Denti



BOYS-ALLIS

150 mm – 6" tk 28210-15

Zähne 5x6

Teeth

Dents

Dientes

Denti



JUDD-ALLIS

150 mm – 6" tk 28250-15

190 mm – 7½" tk 28250-19

Zähne 3x4

Teeth

Dents

Dientes

Denti



BABCOCK

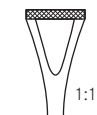

1:1



1:1

160 mm – 6¼" 200 mm – 8"

tk 28285-16 tk 28285-20

TUCAR



BABCOCK

160 mm – 6¼" tk 28280-16

180 mm – 7" tk 28280-18

200 mm – 8" tk 28280-20

240 mm – 9½" tk 28280-24

**Gewebe- und Darmfasszangen**  
*Tissue and intestinal holding forceps*

Pinces intestinales et de tissu  
*Pinzas para tejidos y intestinos*  
 Pinze per tessuti ed intestinali

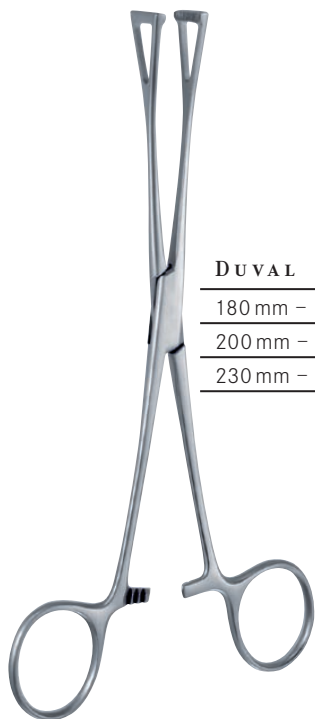

**D U V A L**

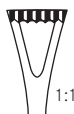

180 mm – 7"	<b>tk 28290-18</b>	
200 mm – 8"	<b>tk 28290-20</b>	<b>tk 28292-20</b>
230 mm – 9"	<b>tk 28290-23</b>	<b>tk 28292-23</b>



**D U V A L**

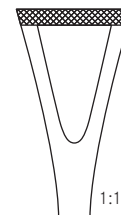

200 mm – 8"	<b>tk 28293-20</b>
-------------	--------------------

**TUGAR<sup>TK</sup>**

1:2

Gewebe- und Darmfazzangen  
*Tissue and intestinal holding forceps*

Pinces intestinales et de tissue  
*Pinzas para tejidos y intestinos*  
Pinze per tessuti ed intestinali

**ATRAUMTK**



**BABCOCK-  
ATRAUMA**



1:1



1:1

160 mm – 6¼"

200 mm – 8"

**tk 22452-16**

**tk 22452-20**



**DUVAL-  
ATRAUMA**



1:1

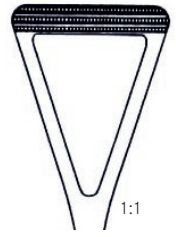

1:1

200 mm – 8"

230 mm – 9"

**tk 22455-20**

**tk 22455-23**



**ALLIS-  
ATRAUMA**



1:1



1:1



1:1

160 mm – 6¼"

200 mm – 8"

250 mm – 9¾"

**tk 22450-16**

**tk 22450-20**

**tk 22450-25**

Darm- und Magenklammern  
*Intestinal and stomach clamps*

Pinces-clamps pour l'intestin et l'estomac  
*Pinzas-clamps para el intestino y el estomago*  
 Pinze per intestino e stomaco

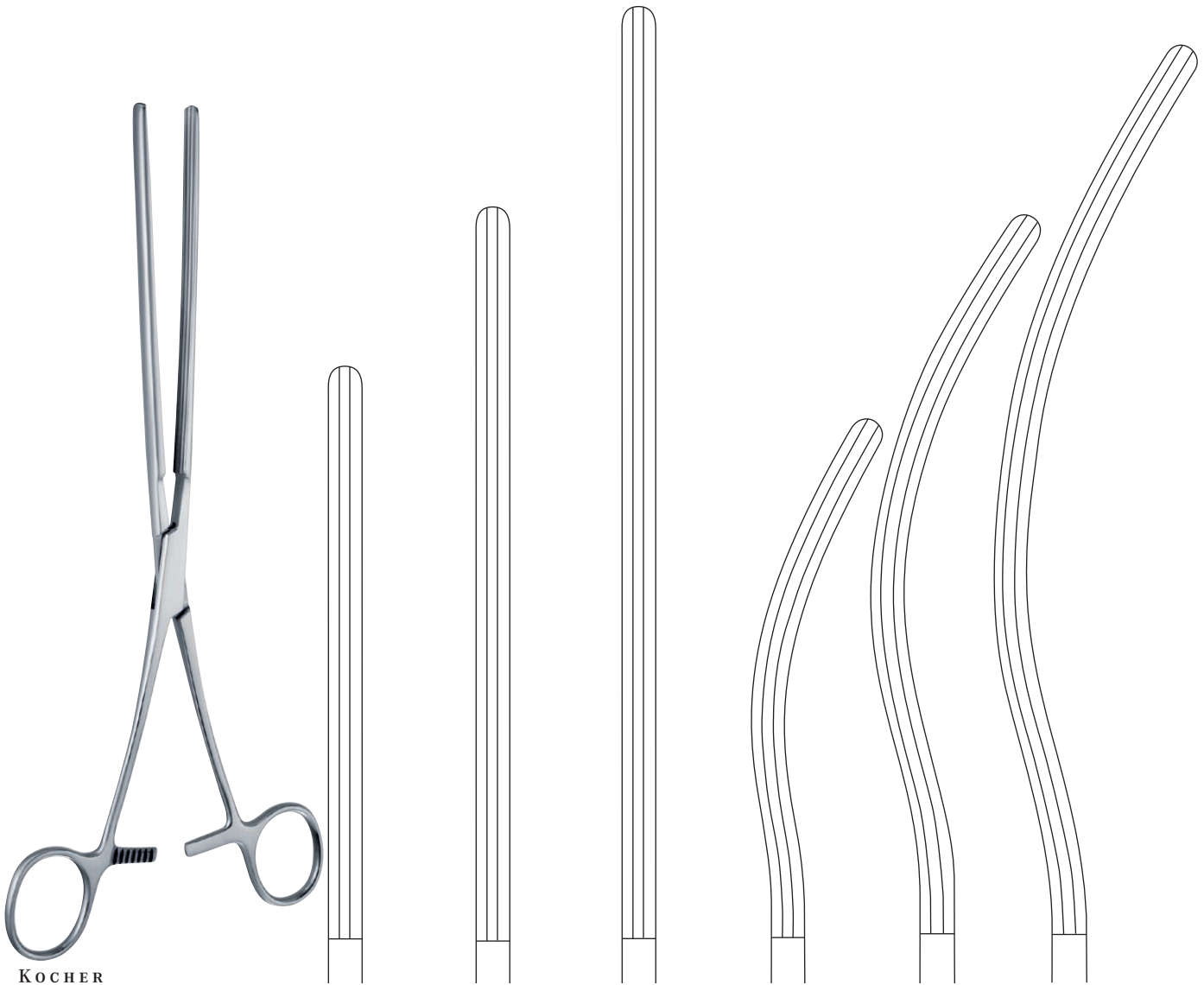

KOCHER

	220 mm – 8 <sup>3</sup> / <sub>4</sub> "	250 mm – 9 <sup>3</sup> / <sub>4</sub> "	280 mm – 11 "	220 mm – 8 <sup>3</sup> / <sub>4</sub> "	250 mm – 9 <sup>3</sup> / <sub>4</sub> "	280 mm – 11 "
	<b>tk 28300-22</b>	<b>tk 28300-25</b>	<b>tk 28300-28</b>	<b>tk 28301-22</b>	<b>tk 28301-25</b>	<b>tk 28301-28</b>

Darm- und Magenklappen  
*Intestinal and stomach clamps*

Pinces-clamps pour l'intestin et l'estomac  
*Pinzas-clamps para el intestino y el estomago*  
 Pinze per intestino e stomaco

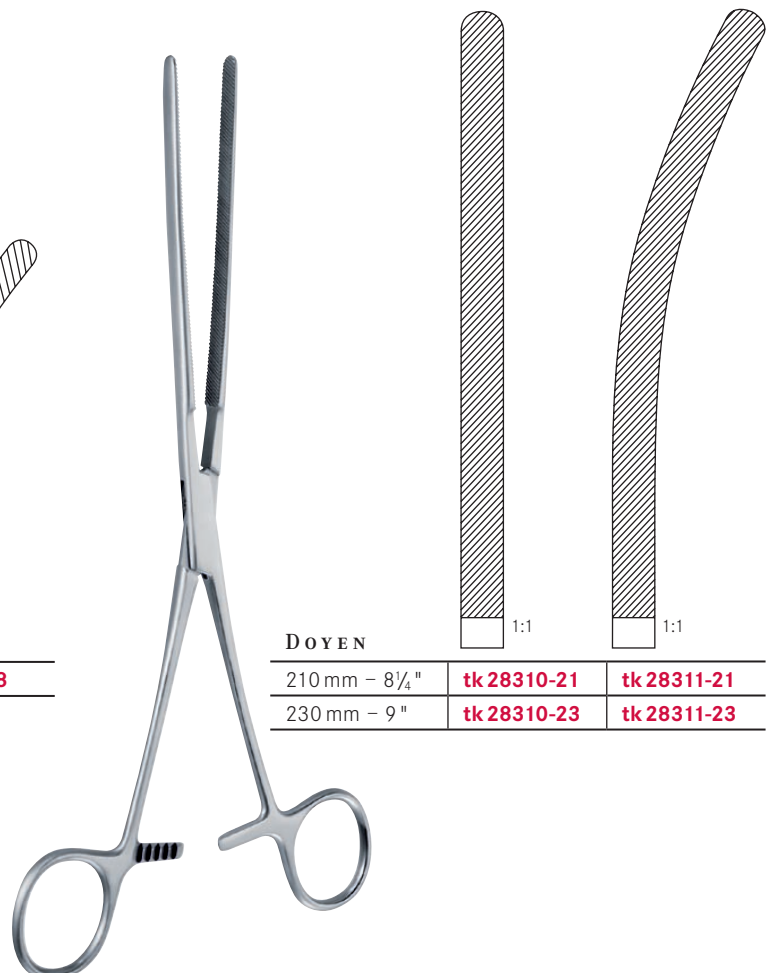
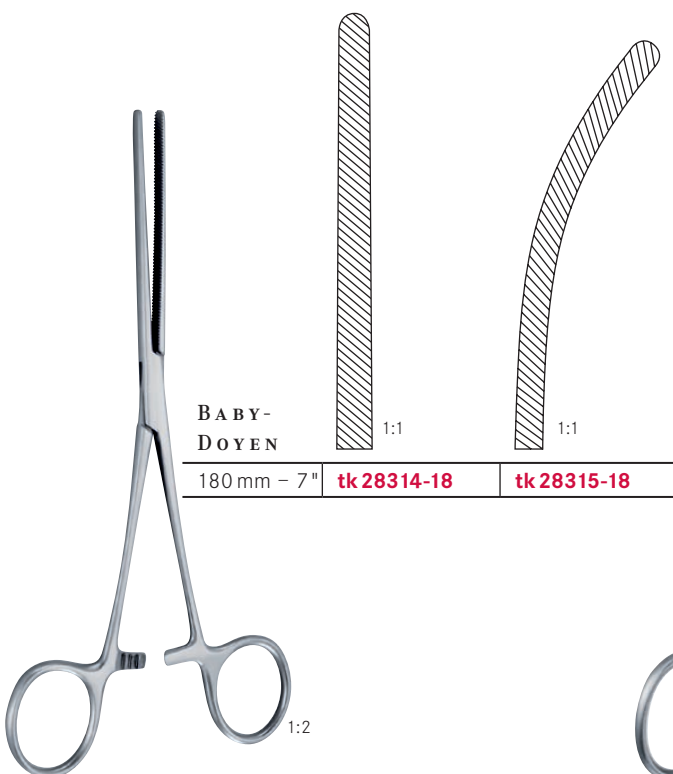
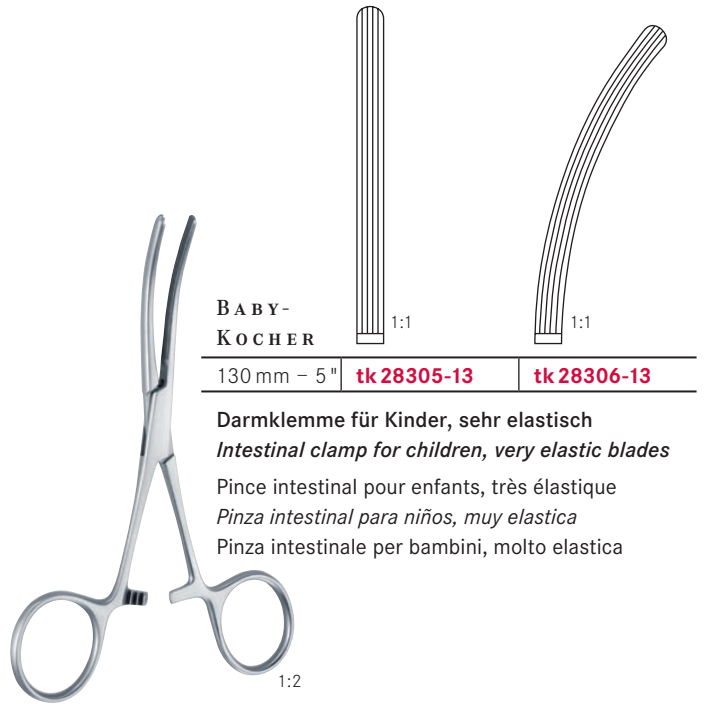
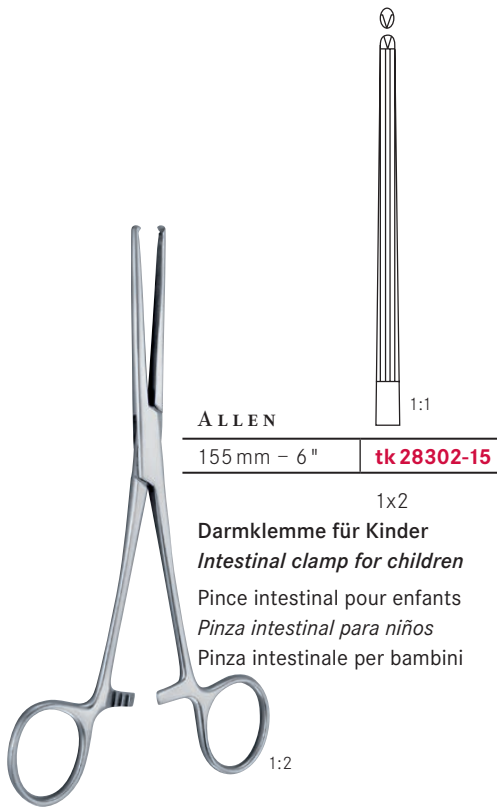



**Darm- und Magenklammern**  
*Intestinal and stomach clamps*

Pinces-clamps pour l'intestin et l'estomac  
*Pinzas-clamps para el intestino y el estomago*  
Pinze per intestino e stomaco

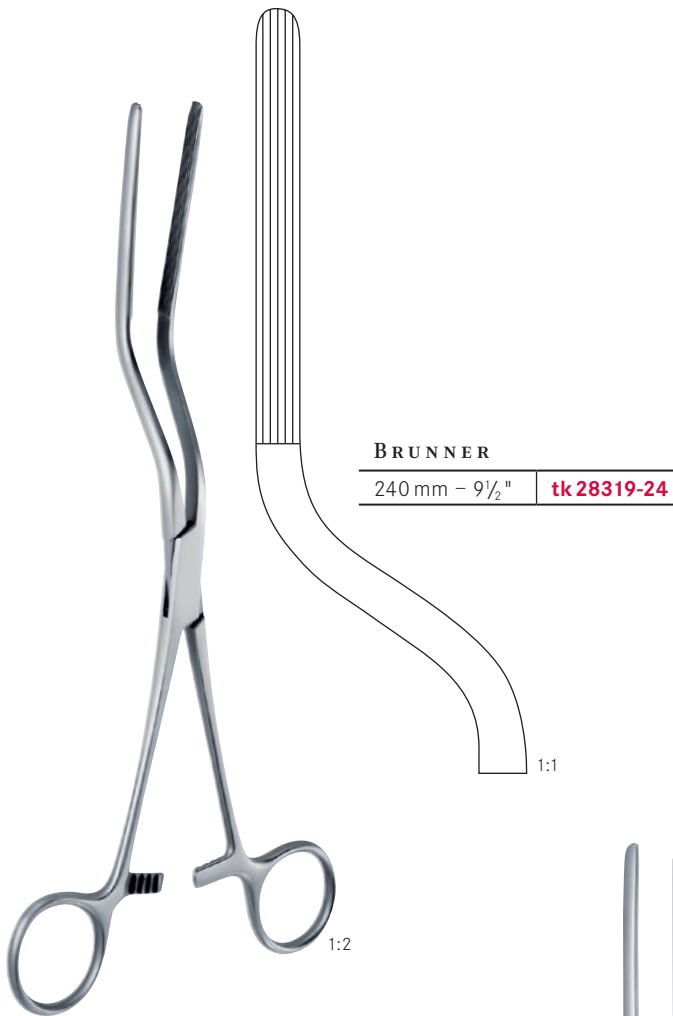

**BRUNNER**  
240 mm – 9½" **tk 28319-24**

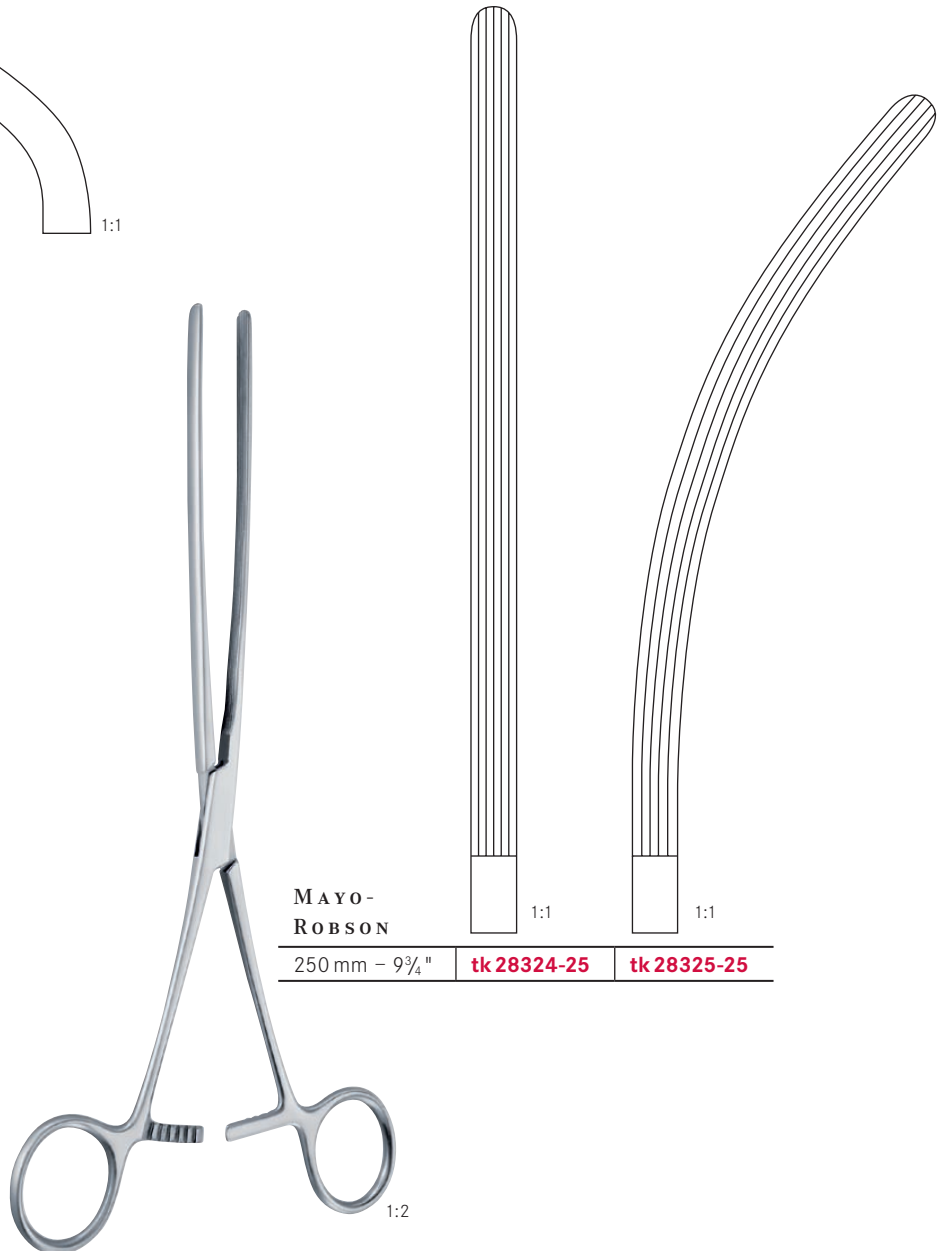

**MAYO-ROBSON**  
250 mm – 9¾" **tk 28324-25** **tk 28325-25**

Darm- und Magenklammern  
*Intestinal and stomach clamps*

Pinces-clamps pour l'intestin et l'estomac  
*Pinzas-clamps para el intestino y el estomago*  
Pinze per intestino e stomaco

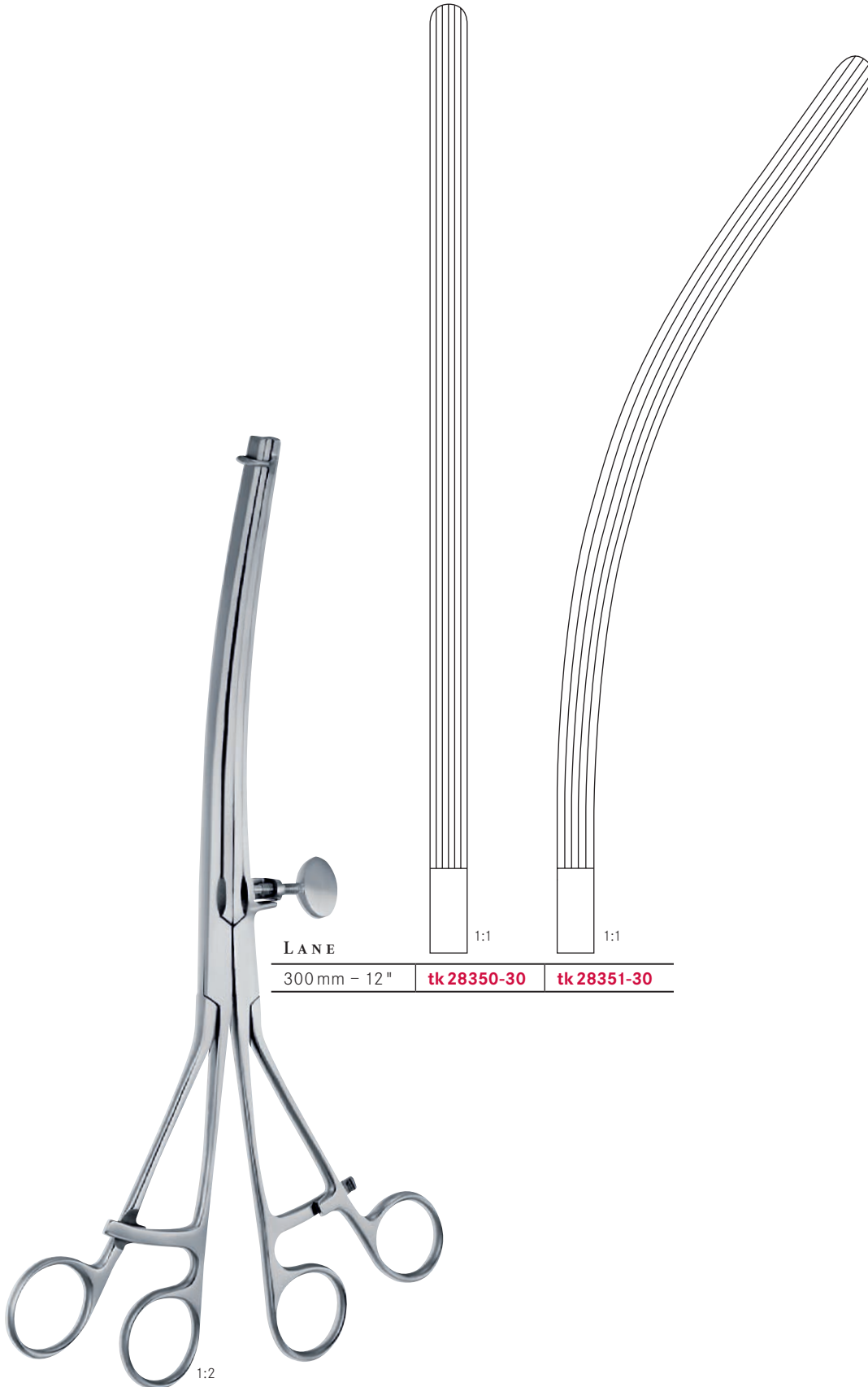

Atraumatische Darmklemmen  
Atraumatic intestinal clamp forceps

Pinces-clamps atraumatiques pour l'intestin  
Pinzas-clamps atraumáticas intestinales  
Pinze intestinali atraumatiche

ATRAUMTK

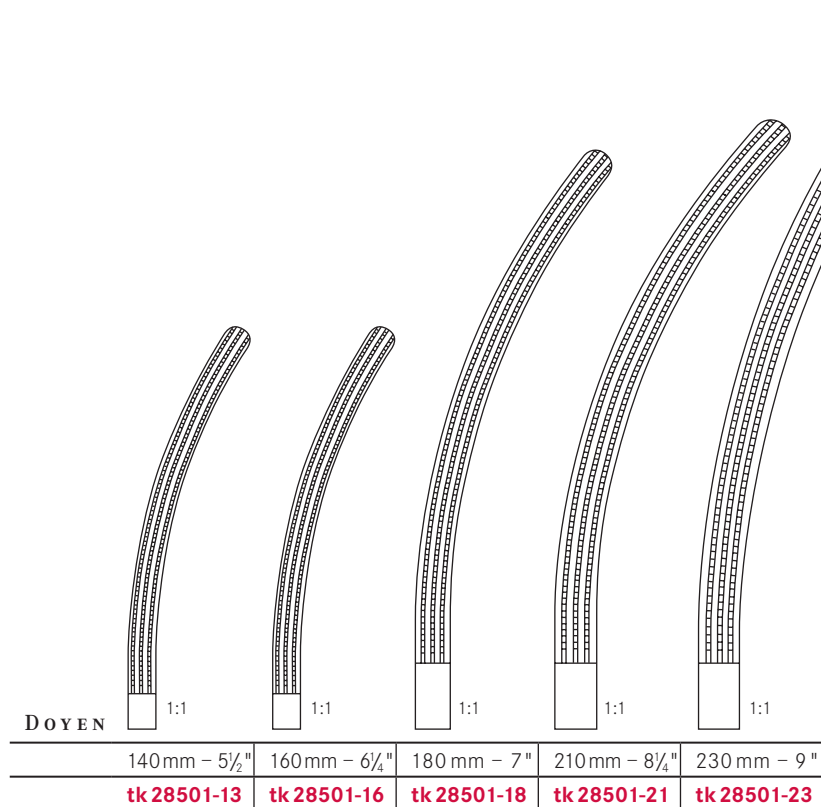
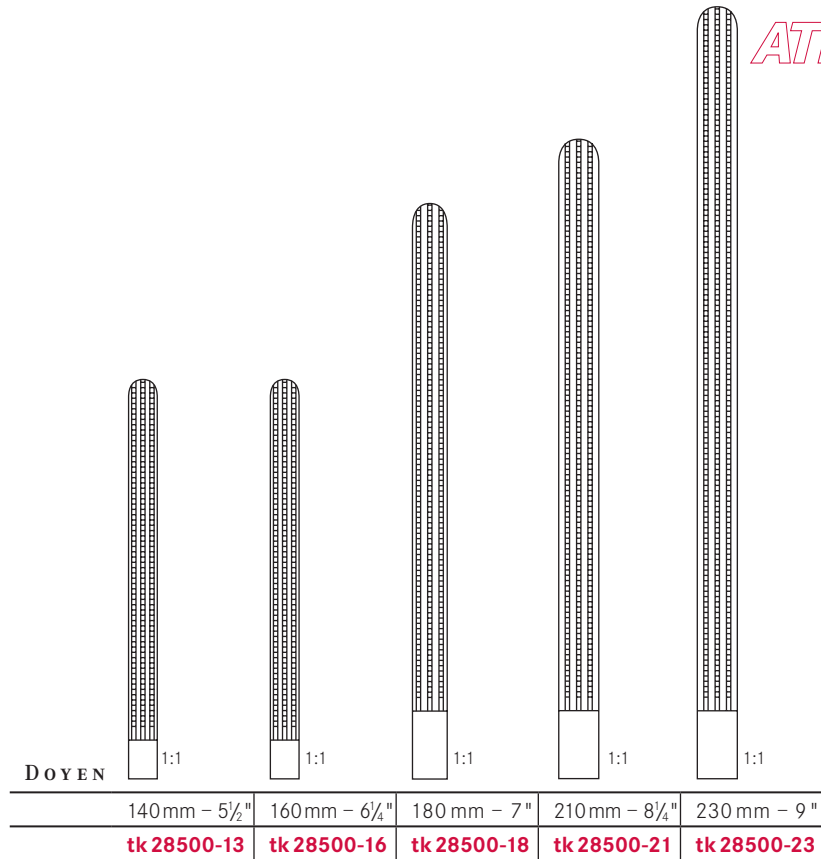

Atraumatische Darmklemmen  
*Atraumatic intestinal clamp forceps*

Pinces-clamps atraumatiques pour l'intestin  
*Pinzas-clamps atraumáticas intestinales*  
Pinze intestinali atraumatiche

**ATRAUMTK**

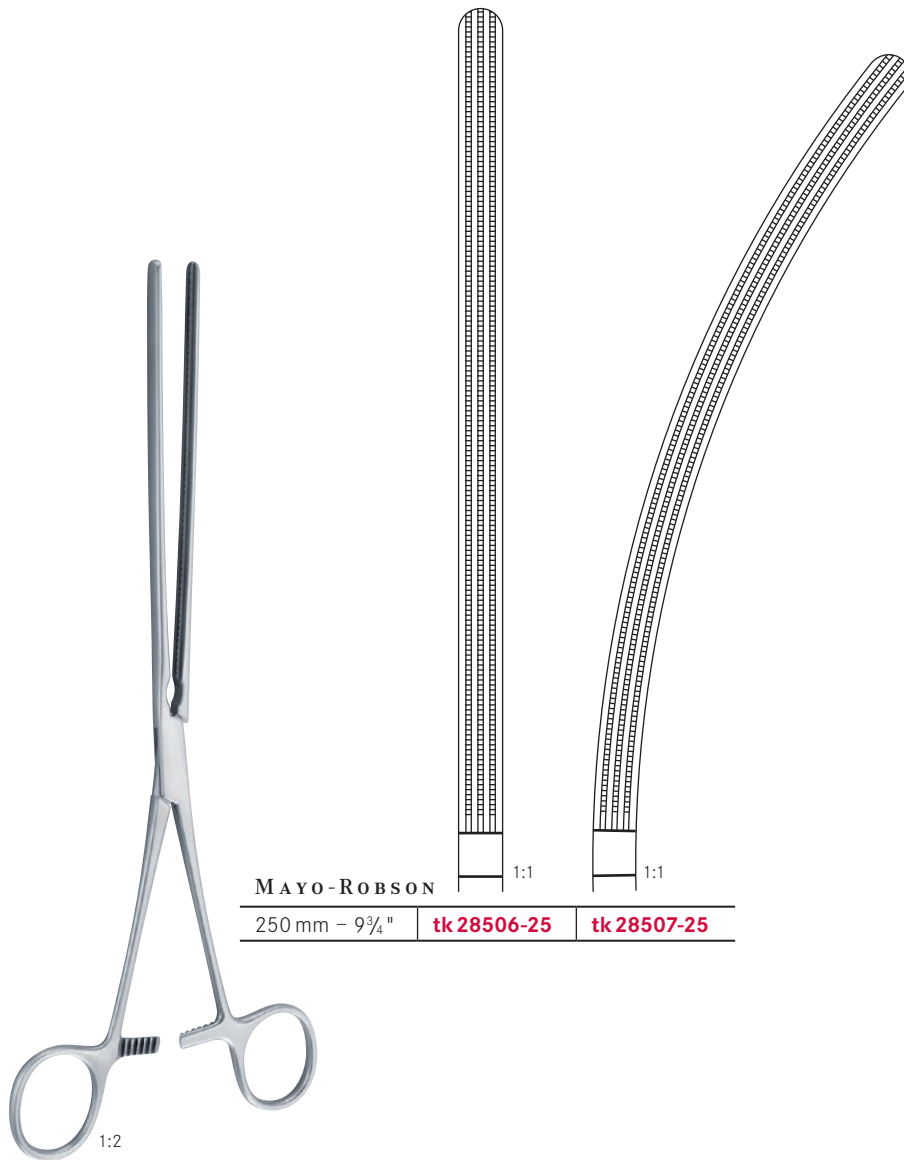

Atraumatische Darmklemmen  
Atraumatic intestinal clamp forceps

Pinces-clamps atraumatiques pour l'intestin  
Pinzas-clamps atraumáticas intestinales  
Pinze intestinali atraumatiche

ATRAUMTK

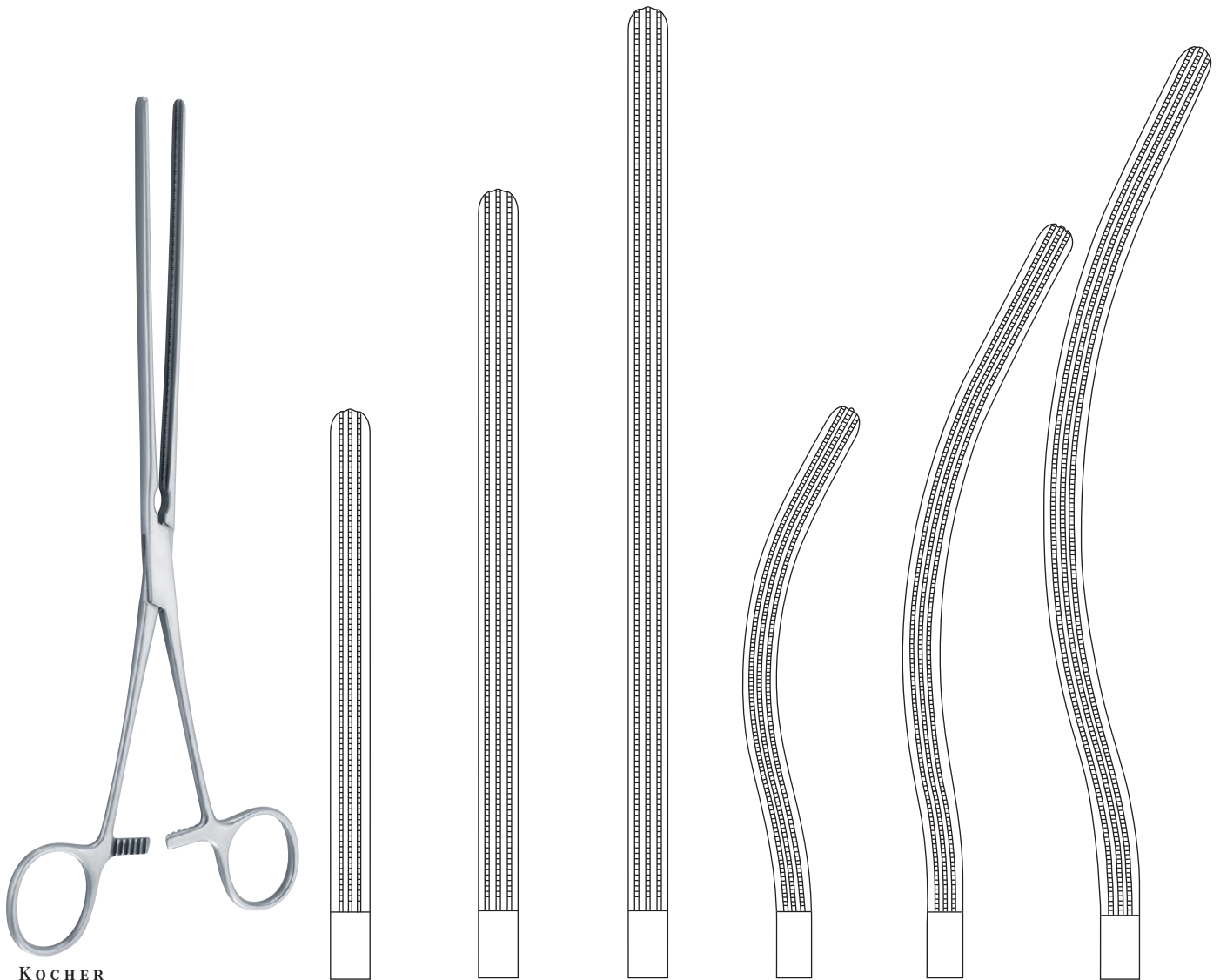

KOCHER

	220 mm – 8 <sup>3</sup> / <sub>4</sub> "	250 mm – 9 <sup>3</sup> / <sub>4</sub> "	280 mm – 11 "	220 mm – 8 <sup>3</sup> / <sub>4</sub> "	250 mm – 9 <sup>3</sup> / <sub>4</sub> "	280 mm – 11 "
	<b>tk 28510-22</b>	<b>tk 28510-25</b>	<b>tk 28510-28</b>	<b>tk 28511-22</b>	<b>tk 28511-25</b>	<b>tk 28511-28</b>

Atraumatische Darmklemmen  
*Atraumatic intestinal clamp forceps*

Pinces-clamps atraumatiques pour l'intestin  
*Pinzas-clamps atraumáticas intestinales*  
Pinze intestinali atraumatiche

**ATRAUM**TK



Rektum-Anastomosenklemmen  
Sigmoid anastomosis forceps

Pinces pour anastomoses rectales  
Pinzas para anastomosis rectales  
Pinze per anastomosi rettali

ATRAUMTK

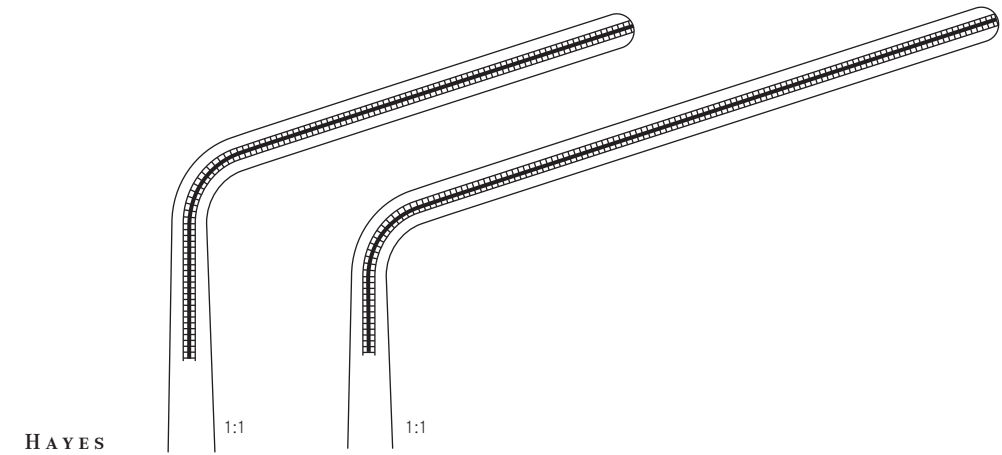

HAYES	1:1	1:1
	260 mm – 10 1/4"	280 mm – 11"
	tk 28526-26	tk 28526-28

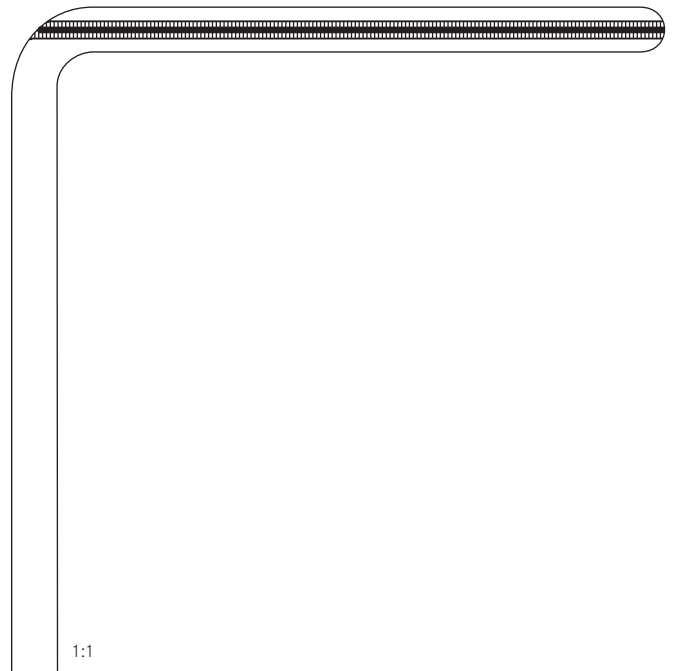

FEHLAND
240 mm – 9 1/2"
tk 28528-24

Rektum-Anastomosenklemmen  
*Sigmoid anastomosis forceps*

Pinces pour anastomoses rectales  
*Pinzas para anastomosis rectales*  
Pinze per anastomosi rettali

**ATRAUMTK**

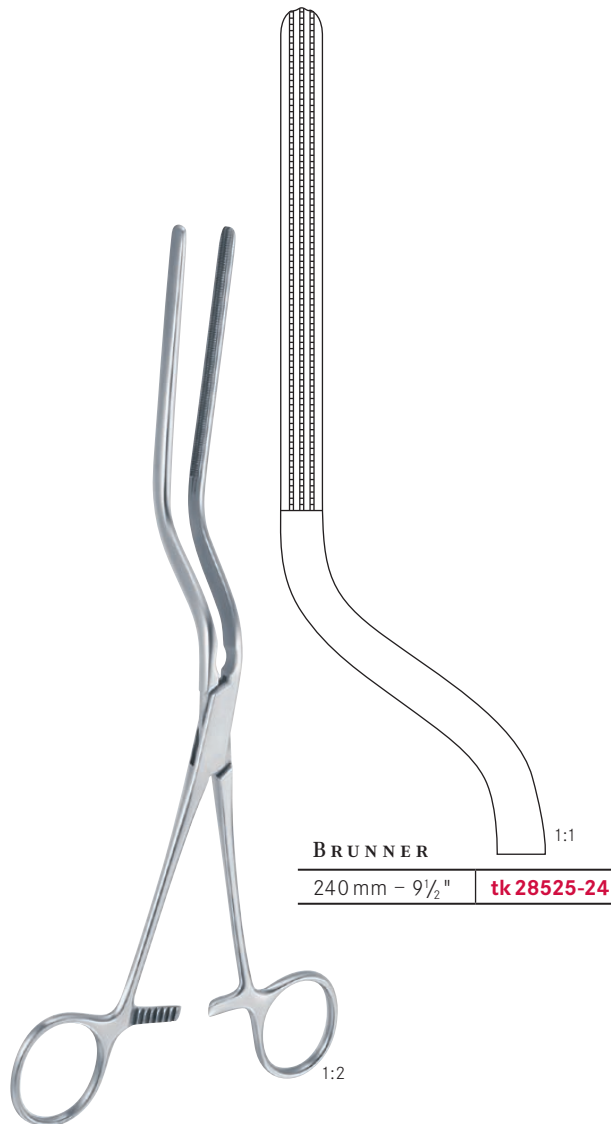



**Atraumatische Organfasszangen**  
**Atraumatic organ grasping forceps**

Pinces atraumatiques pour saisir des organes  
 Pinzas atraumaticas para sacar órganos  
 Pinze atraumatiche per afferrare organi

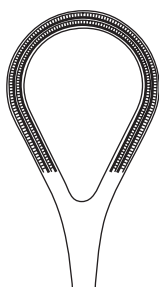

250 mm – 9¾" **tk 22014-25**

Organfasszange mittel, 250 mm  
 Organ grasping forceps medium, 250 mm  
 Pince medium pour saisir des organes, 250 mm  
 Pinza mediano para sacar órganos, 250 mm  
 Pinze per afferrare organi, 250 mm

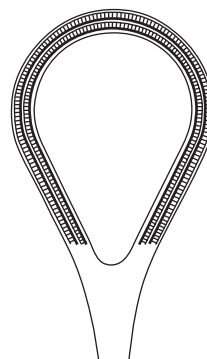

260 mm – 10¼" **tk 22014-26**

Organfasszange gross, 260 mm  
 Organ grasping forceps large, 260 mm  
 Pince grande pour saisir des organes, 260 mm  
 Pinza grande para sacar órganos, 260 mm  
 Pinze per afferrare organi, 260 mm

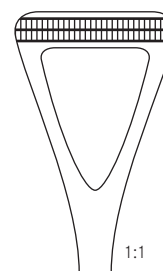

SCHEIBE

1:1

1:1

1:1

180 mm – 7"

200 mm – 8"

230 mm – 9"

**tk 28470-18**

**tk 28470-20**

**tk 28470-23**

**schmal**  
*narrow*

**mittel**  
*medium*

**breit**  
*wide*

étroit  
*estrecho*  
stretto

moyen  
*mediano*  
medio

large  
*ancho*  
largo

Darmquetschklemmen  
*Intestinal and pylorus clamps*

Ecraseur pour l'intestin  
*Pinzas intestinales para píloro*  
Schiacciatori intestinali



PAYR-BABY

150 mm – 6"

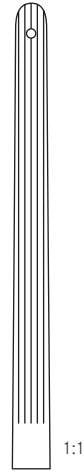

1:1

**tk 28410-15**

mit Stift  
*with pin*  
avec cheville  
*con pivote*  
con perno



PAYR

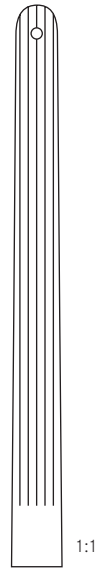

1:1

210 mm – 8 1/4"

**tk 28410-21**

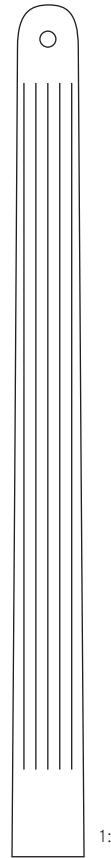

1:1

290 mm – 11 1/2"

**tk 28410-29**

mit Stift  
*with pin*  
avec cheville  
*con pivote*  
con perno

Darm- und Anastomosenklemmen  
*Intestinal and anastomosis clamp forceps*

Pinces-clamps intestinales et à anastomose  
*Pinzas-clamps intestinales y para anastomosis*  
 Pinze intestinali e per anastomosi



1:2

85 mm - 3 1/4"

**tk 28452-08**

DE MARTEL-  
WOLFSON



1:2

230 mm - 9"

**tk 28452-23**



DE MARTEL-  
WOLFSON

260 mm - 10 1/4"

**tk 28451-26**

1:2

Darm- und Anastomosenklemmen  
*Intestinal and anastomosis clamp forceps*

Pinces-clamps intestinales et à anastomose  
*Pinzas-clamps intestinales y para anastomosis*  
Pinze intestinali e per anastomosi



DE MARTEL-  
WOLFSON

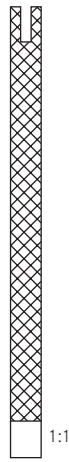

50 mm – 2 "	70 mm – 2¾ "	100 mm – 4 "
<b>tk 28450-05</b>	<b>tk 28450-07</b>	<b>tk 28450-10</b>

Satz mit 3 Klemmen

*Set of 3 clamps*

*Jeu de 3 clamps*

*Juego de 3 pinzas*

*Serie di 3 pezzi*

**Mastdarm-Spekula**  
*Rectal specula*

Spéculums pour le rectum  
*Espéculos rectales*  
Specoli rettali



**SIMS**

	x = 80 mm x 15 mm	x = 80 mm x 15 mm
150 mm – 6"	<b>tk 29001-15</b>	<b>tk 29002-15</b>



**MATHIEU**

	x = 90 mm
195 mm – 7¾"	<b>tk 29003-19</b>

Mastdarm-Spekula  
*Rectal specula*

Spéculums pour le rectum  
*Espéculos rectales*  
Specoli rettali



PRATT

1:2

	x = 80 mm x 25 mm
205 mm – 8"	<b>tk 29006-20</b>



CZERNY

1:2

	x = 110 mm x 25 mm
220 mm – 8¾"	<b>tk 29004-22</b>

**Anuskope – Sphinkteroskope**  
**Anoscopes – Sphincteroscopes**

**Anoscopes – Sphinctérosopes**  
**Anoscopios – Sfinteroscopios**  
**Anoscopi – Sfinteroscopi**



**IVES-FANSLER**

	x=90 mm
22 mm Ø	<b>tk 29011-80</b>

1:2



**KELLY**

	x= 50 mm
21 mm Ø	<b>tk 29012-50</b>
27 mm Ø	<b>tk 29013-50</b>



**BENSAUDE**

	185 mm – 7¼"
	x = 55 mm
20 mm Ø	<b>tk 29067-20</b>
23 mm Ø	<b>tk 29067-23</b>



Anuskope – Sphinkteroskope  
Anoscopes – Sphincteroscopes

Anuscopes – Sphinctéscopes  
Anoscopios – Esfinteroscopios  
Anoscopi – Sfinteroscopi



HIRSCHMANN

16 mm Ø	x = 60 mm	tk 29065-16
19 mm Ø	x = 70 mm	tk 29065-19
22 mm Ø	x = 90 mm	tk 29065-22

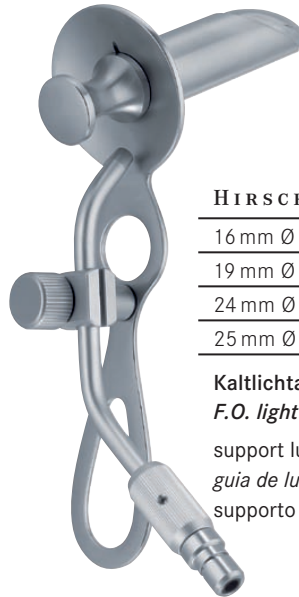

HIRSCHMANN

16 mm Ø	tk 29063-16
19 mm Ø	tk 29063-19
24 mm Ø	tk 29063-24
25 mm Ø	tk 29063-25

Kaltlichtaufsatz, Wolf  
F.O. light carrier, Wolf

support lumière froide, Wolf  
guía de luz fría, Wolf  
supporto per luce fredda, Wolf

tk 700-997

Kaltlichtadapter, TEKNO/Storz Anschluss  
Cold light, TEKNO/Storz connector

Adaptateur lum. froide, connection TEKNO/Storz  
Adaptator luz fría, conexión TEKNO/Storz  
Adattatore luce freddo, attacco TEKNO/Storz

Analpreizer  
Rectal specula

Spéculums pour le rectum  
Espéculos rectales  
Divaricatore anale



SMITH-BUIE

	x = 75 mm x 23 mm
150 mm – 6"	tk 29070-15

Max. Spreizweite 115 mm  
Max. speed 115 mm

Écartement maximal 115 mm  
Apertura máxima 115 mm  
Apertura massima 115 mm



Anal spreizer  
Rectal specula

Spéculums pour le rectum  
Espéculos rectales  
Divaricatore anale



ALAN PARKS

140 mm – 5½" tk 29020-00

komplett mit 2 Paar Valven und 1 Mittelvalve  
complete with 2 pair of blades and 1 center blade  
complet avec 2 paires des valves et 1 valve centrale  
completo con 2 juegos de valvas y 1 valva central  
completo con 2 paia di valve e 1 valva centrale

22 mm x 75 mm tk 29020-02

Seitenvalven alleine (Paar)  
Lateral blades only (pair)  
Valves latérales seules (paire)  
Valvas laterales solas (par)  
Valve laterali solo (paio)

22 mm x 95 mm tk 29020-04

Seitenvalven alleine (Paar)  
Lateral blades only (pair)  
Valves latérales seules (paire)  
Valvas laterales solas (par)  
Valve laterali solo (paio)

25 mm x 95 mm tk 29020-06

Mittelvalve alleine  
Central blade only  
Valve centrale seule  
Valva central sola  
Valva centrale solo



ALAN PARKS

140 mm – 5½" tk 29022-00

komplett mit 2 Paar Valven und 1 Mittelvalve, mit Kaltlichtanschluss TEKNO/Wolf  
complete with 2 pair of blades and 1 center blade, with cold light connector TEKNO/Wolf  
complet avec 2 paires des valves et 1 valve centrale, avec raccord de lum. froide TEKNO/Wolf  
completo con 2 juegos de valvas y 1 valva central, con connector de luz fría TEKNO/Wolf  
completo con 2 paia di valve e 1 valva centrale, con attacco di luce fredda TEKNO/Wolf

tk 29022-01

Kaltlicht-Aufsatz  
F.O. light carrier  
Support lumière froide  
Soporte de luz fría  
Supporto per luce fredda

Rektoskop  
*Rectoscope*

Rectoscope  
*Rectoscopio*  
Rettoscopio

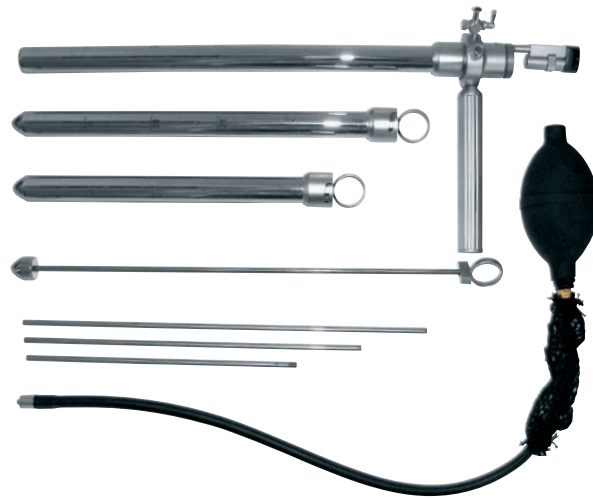

STRAUSS

**tk 28531-01**

Kaltlicht-Rektoskop, komplett:

F/O Rektoskopkopf mit Zweiwegehahn, Verschlussdeckel, Teleskop und Griff,  
je 1 Rektoskoptubus in 200 mm, 250 mm und 300 mm mit 20 mm Ø,  
mit Obturator und F/O Lichtträger Wolf-Anschluss, Doppelgebläse mit Kaltlichteinrichtung

*Cold-light rectoscope, complete:*

*F/O Rectoscope-head with two-way stop cock, lens cover and telescope handle,  
3 rectoscope-tubes 20 mm Ø 200 mm, 250 mm and 300 mm  
with obturator and F/O light-carrier Wolf, with double blower, with cold light connection*

Rectoscope à lumière froide, complet:

F/O tête de rectoscope avec robinet, protecteur de lentille, optique et manche,  
3 tubes de rectoscope 20 mm Ø, 200 mm, 250 mm et 300 mm de longueur,  
avec mandrin et porte-lumière Wolf (F/O), souffleur et connecteur de lumière froide.

*Rectoscopio de luz fria, completo:*

*F/O cabeza de rectoscopio, con robinete protector de lentes, optica y mango,  
3 tubos de rectoscopia de 20 mm, Ø 200 mm, 250 mm y 300 mm de longitud,  
con obturador y connector de luz fria Wolf y soplador.*

Luce fredda-Rettoscopio, completo

Testa di rettoscopio con fibre ottiche, con rubinetto a due vie, copri-lente e impugnatura per ottica,  
3 tubi per rettoscopio 20 mm Ø, 200 mm, 250 mm e 300 mm  
con otturatore e cavo luce, insufflatore a doppia palla e connettore per cavo luce, allacciamento Wolf.

**tk 700-997**

Kaltlichtadapter TEKNO/Storz

*Cold light connector TEKNO/Storz*

Raccord de lumière froide TEKNO/Storz

*Connector de luz fria TEKNO/Storz*

Attacco luce fredda TEKNO/Storz

**Mastdarm-Biopsiezangen**  
*Rectal biopsy forceps*

Pinces pour la biopsie rectale  
*Pinzas para biopsia rectal*  
Pinze taglianti per biopsia rettale

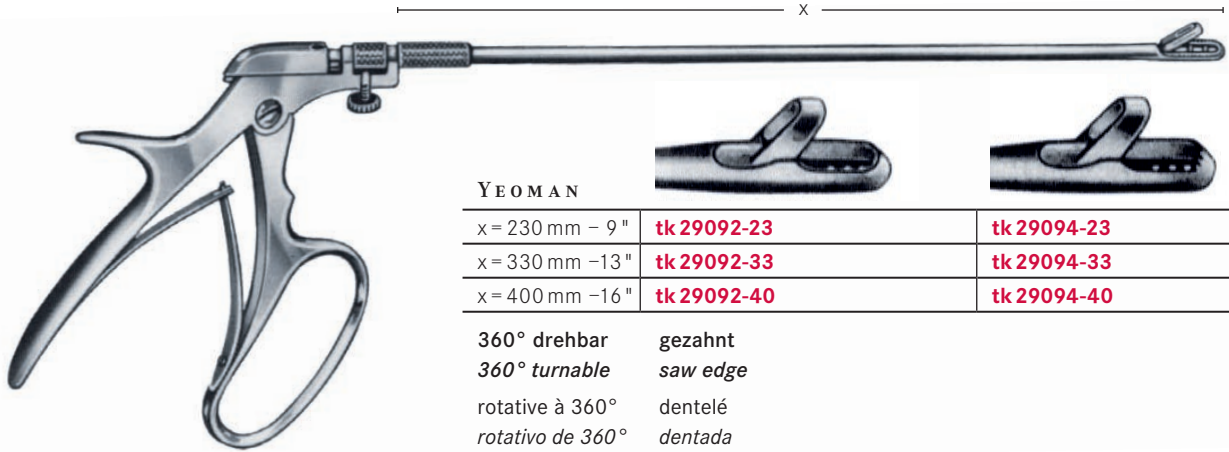

**YEOMAN**

x = 230 mm – 9"	<b>tk 29092-23</b>	<b>tk 29094-23</b>
x = 330 mm – 13"	<b>tk 29092-33</b>	<b>tk 29094-33</b>
x = 400 mm – 16"	<b>tk 29092-40</b>	<b>tk 29094-40</b>

360° drehbar *gezahnt*  
360° turnable *saw edge*  
rotative à 360° *dentelé*  
rotativo de 360° *dentada*  
rotativa di 360° *dentata*





**TURREL**

x = 230 mm – 9"	<b>tk 29096-23</b>	<b>tk 29098-23</b>
x = 330 mm – 13"	<b>tk 29096-33</b>	<b>tk 29098-33</b>
x = 400 mm – 16"	<b>tk 29096-40</b>	<b>tk 29098-40</b>

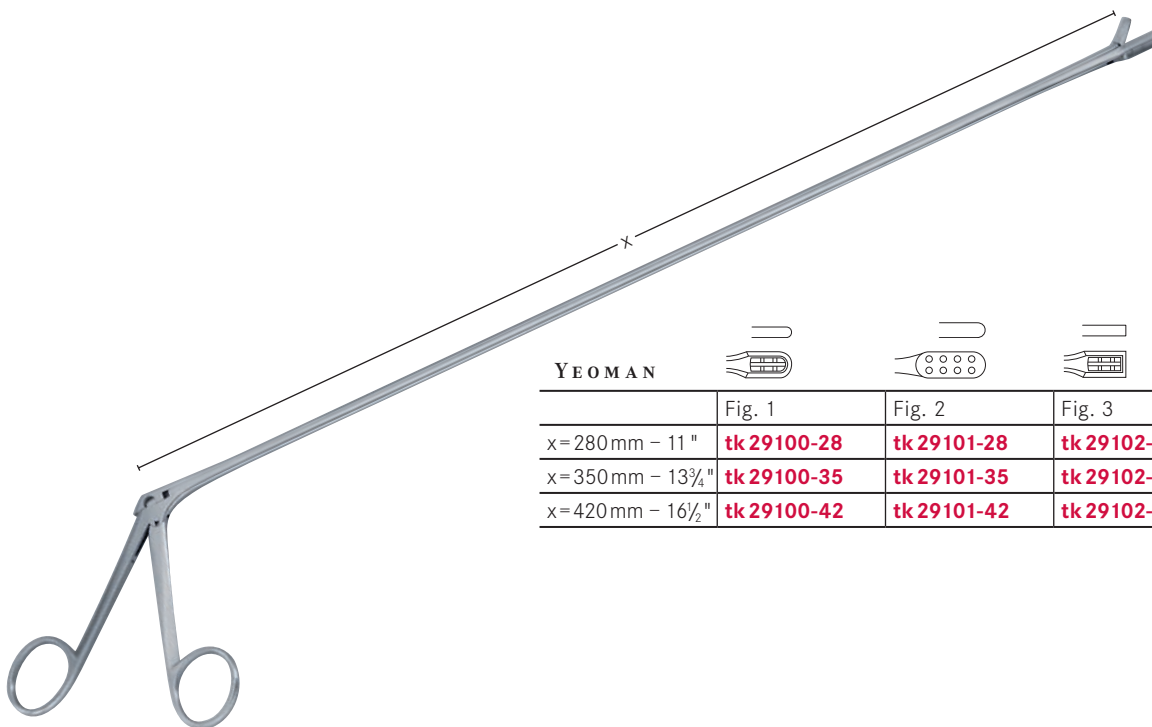
360° drehbar *gezahnt*  
360° turnable *saw edge*  
rotative à 360° *dentelé*  
rotativo de 360° *dentada*  
rotativa di 360° *dentata*

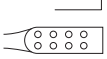

**YEOMAN**

				
	Fig. 1	Fig. 2	Fig. 3	Fig. 4
x = 280 mm – 11"	<b>tk 29100-28</b>	<b>tk 29101-28</b>	<b>tk 29102-28</b>	<b>tk 29103-28</b>
x = 350 mm – 13¾"	<b>tk 29100-35</b>	<b>tk 29101-35</b>	<b>tk 29102-35</b>	<b>tk 29103-35</b>
x = 420 mm – 16½"	<b>tk 29100-42</b>	<b>tk 29101-42</b>	<b>tk 29102-42</b>	<b>tk 29103-42</b>

Flexible Zangen  
Flexible forceps

Pincas flexibles  
Pinzas flexibles  
Pinze flessibili



	1.8 mm Ø	2.2 mm Ø	2.6 mm Ø	3.4 mm Ø
120 mm – 47¼"	<b>tk 31100-12</b>	<b>tk 31110-12</b>		
160 mm – 63"	<b>tk 31100-16</b>	<b>tk 31110-16</b>	<b>tk 31120-16</b>	<b>tk 31130-16</b>
180 mm – 70¾"	<b>tk 31100-18</b>	<b>tk 31110-18</b>		
230 mm – 90½"	<b>tk 31100-23</b>	<b>tk 31110-23</b>	<b>tk 31120-23</b>	<b>tk 31130-23</b>



	1.8 mm Ø	2.2 mm Ø	2.6 mm Ø	3.4 mm Ø
120 mm – 47¼"	<b>tk 31101-12</b>	<b>tk 31111-12</b>		
160 mm – 63"	<b>tk 31101-16</b>	<b>tk 31111-16</b>	<b>tk 31121-16</b>	<b>tk 31131-16</b>
180 mm – 70¾"	<b>tk 31101-18</b>	<b>tk 31111-18</b>		
230 mm – 90½"	<b>tk 31101-23</b>	<b>tk 31111-23</b>	<b>tk 31121-23</b>	<b>tk 31131-23</b>



	1.8 mm Ø	2.2 mm Ø	3.4 mm Ø
120 mm – 47¼"	<b>tk 31102-12</b>	<b>tk 31112-12</b>	
160 mm – 63"	<b>tk 31102-16</b>	<b>tk 31112-16</b>	<b>tk 31132-16</b>
180 mm – 70¾"	<b>tk 31102-18</b>	<b>tk 31112-18</b>	
230 mm – 90½"	<b>tk 31102-23</b>	<b>tk 31112-23</b>	<b>tk 31132-23</b>



	1.8 mm Ø	2.2 mm Ø	3.4 mm Ø
120 mm – 47¼"	<b>tk 31103-12</b>	<b>tk 31113-12</b>	
160 mm – 63"	<b>tk 31103-16</b>	<b>tk 31113-16</b>	<b>tk 31133-16</b>
180 mm – 70¾"	<b>tk 31103-18</b>	<b>tk 31113-18</b>	
230 mm – 90½"	<b>tk 31103-23</b>	<b>tk 31113-23</b>	<b>tk 31133-23</b>

Flexible Zangen  
Flexible forceps

Pinces flexibles  
Pinzas flexibles  
Pinze flessibili



	1.8 mm Ø	2.2 mm Ø
160 mm – 63"	<b>tk 31140-16</b>	<b>tk 31150-16</b>
230 mm – 90½"	<b>tk 31140-23</b>	<b>tk 31150-23</b>



	1.8 mm Ø	2.2 mm Ø
160 mm – 63"	<b>tk 31142-16</b>	<b>tk 31152-16</b>
230 mm – 90½"	<b>tk 31142-23</b>	<b>tk 31152-23</b>



	1.8 mm Ø	2.2 mm Ø
160 mm – 63"	<b>tk 31143-16</b>	<b>tk 31153-16</b>
230 mm – 90½"	<b>tk 31143-23</b>	<b>tk 31153-23</b>

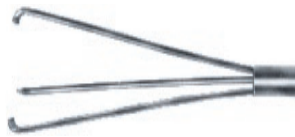

	1.8 mm Ø	2.2 mm Ø
160 mm – 63"	<b>tk 31146-16</b>	<b>tk 31156-16</b>
230 mm – 90½"	<b>tk 31146-23</b>	<b>tk 31156-23</b>

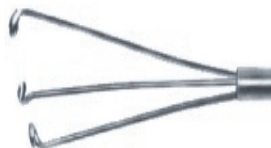

	1.8 mm Ø	2.2 mm Ø
160 mm – 63"	<b>tk 31147-16</b>	<b>tk 31157-16</b>
230 mm – 90½"	<b>tk 31147-23</b>	<b>tk 31157-23</b>

Hämorrhoidal-Zangen  
*Haemorrhoidal forceps*

Pincas hémorroidales  
*Pinzas hemorroidales*  
Pinze emorroidali



LUER  
245 mm – 9¾" **tk 29105-24**

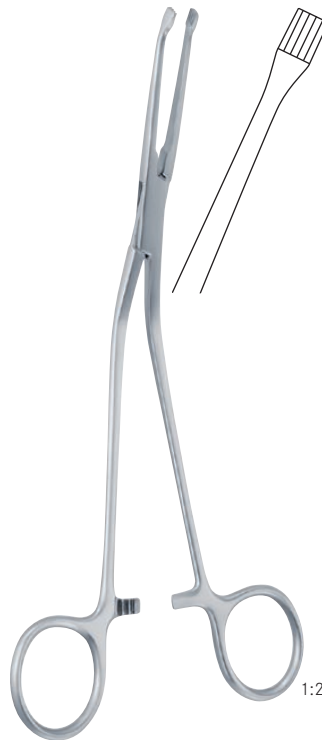

MC GIVNEY

190 mm – 7½" **tk 29111-19**

1x gebogen  
*single curved*  
courbé simple  
*curvado simple*  
curvatura singola

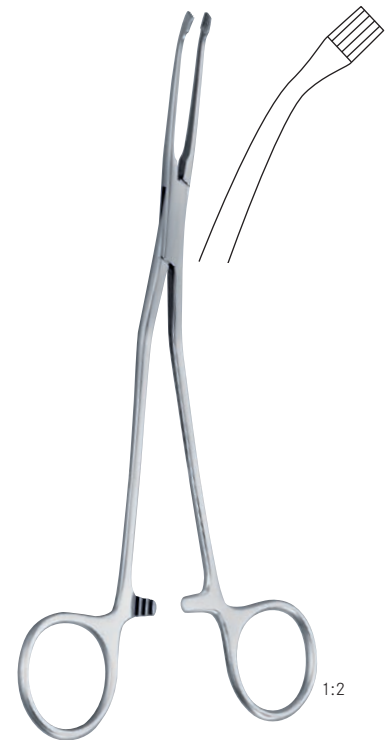

**tk 29112-19**

2x gebogen  
*double curved*  
courbé double  
*curvado doble*  
curvatura doppia

**Polypenfasszangen**  
*Polypus grasping forceps*

Pinces pour saisir polypes  
*Pinzas para coger pólipos*  
Pinze per afferrare polipi



**HEYWOOD-  
SMITH**

200 mm – 8"

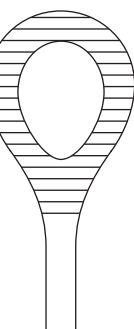

**tk29114-20**



**HEYWOOD-  
SMITH**

210 mm – 8¼"

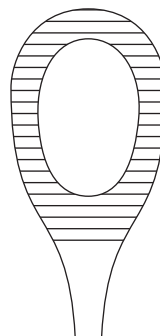

**tk29115-21**

Hämorrhoidal-Ligatoren  
*Haemorrhoidal ligators*

Ligateurs hémorroïdales  
*Ligadores hemorroidales*  
Legatori emorroidali

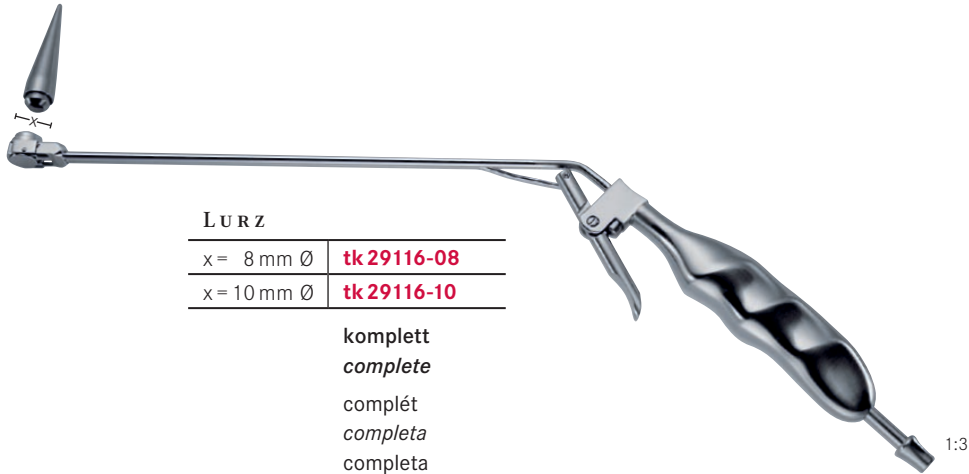

LURZ

x = 8 mm Ø	<b>tk 29116-08</b>
x = 10 mm Ø	<b>tk 29116-10</b>

komplett  
*complete*  
complét  
*completa*  
completa

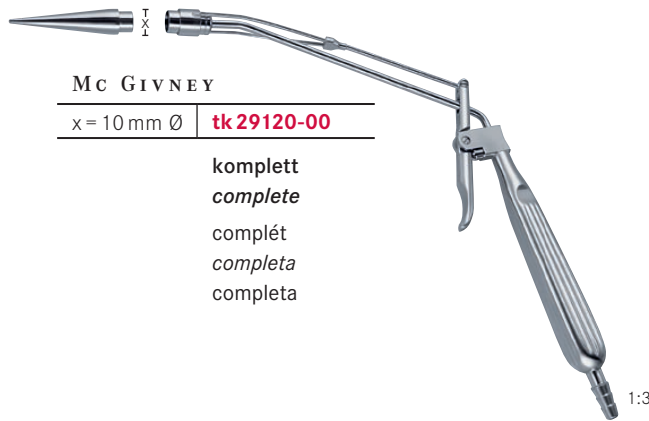

MC GIVNEY

x = 10 mm Ø	<b>tk 29120-00</b>
-------------	--------------------

komplett  
*complete*  
complét  
*completa*  
completa

**tk 29140-00**

Gummiringe, Packung à 100 Stück  
*Rubber rings, package of 100 pieces*

Anneaux de caoutchouc à ligatures, paquet de 100 pièces  
*Anillos de goma para ligaduras, paquete de 100 piezas*  
Anelli di gomma, pacchetto di 100 pezzi



Hämorrhoidal-Ligatoren  
*Haemorrhoidal ligators*

Ligateurs hémorroïdales  
*Ligadores hemorroidales*  
Legatori emorroidali

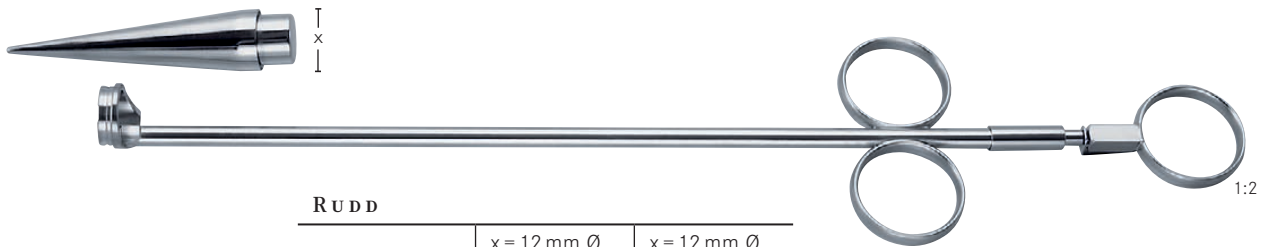

RUDD

	x = 12 mm Ø	x = 12 mm Ø
315 mm – 12½"	<b>tk 29130-00</b>	<b>tk 29130-01</b>

<b>komplett</b>	<b>Ladekegel allein</b>
<b>complete</b>	<b>Cone piece only</b>
complét	Cône seule
completa	Cono solo
completa	Cono solo

**tk 29140-00**

Gummiringe, Packung à 100 Stück  
*Rubber rings, package of 100 pieces*

Anneaux de caoutchouc à ligatures, paquet de 100 pièces  
*Anillos de goma para ligaduras, paquete de 100 piezas*  
Anelli di gomma, pacchetto di 100 pezzi

