



Scheren | Ciseaux
Scissors | Tijeras
Forbici

Chirurgische Scheren
Operating scissors

Ciseaux à chirurgie
Tijeras para cirugía
Forbici per chirurgia



| STANDARD | Fig. 1 | Fig. 2 | Fig. 3 |
|-----------------|-------------------|-------------------|-------------------|
| | 105 mm – 4 1/4" | tk 8023-10 | tk 8024-10 |
| 115 mm – 4 1/2" | tk 8023-11 | tk 8024-11 | tk 8025-11 |
| 130 mm – 5" | tk 8023-13 | tk 8024-13 | tk 8025-13 |
| 145 mm – 5 3/4" | tk 8023-14 | tk 8024-14 | tk 8025-14 |
| 155 mm – 6" | tk 8023-15 | tk 8024-15 | tk 8025-15 |
| 165 mm – 6 1/2" | tk 8023-16 | tk 8024-16 | tk 8025-16 |
| 175 mm – 7" | tk 8023-17 | tk 8024-17 | tk 8025-17 |
| 185 mm – 7 1/4" | tk 8023-18 | tk 8024-18 | tk 8025-18 |
| 200 mm – 8" | tk 8023-20 | tk 8024-20 | tk 8025-20 |



| STANDARD | Fig. 1 | Fig. 2 | Fig. 3 |
|-----------------|-------------------|-------------------|-------------------|
| | 115 mm – 4 1/2" | tk 8033-11 | tk 8034-11 |
| 130 mm – 5" | tk 8033-13 | tk 8034-13 | tk 8035-13 |
| 145 mm – 5 3/4" | tk 8033-14 | tk 8034-14 | tk 8035-14 |
| 155 mm – 6" | tk 8033-15 | tk 8034-15 | tk 8035-15 |
| 165 mm – 6 1/2" | tk 8033-16 | tk 8034-16 | tk 8035-16 |
| 175 mm – 7" | tk 8033-17 | tk 8034-17 | tk 8035-17 |
| 185 mm – 7 1/4" | tk 8033-18 | tk 8034-18 | tk 8035-18 |
| 200 mm – 8" | tk 8033-20 | tk 8034-20 | tk 8035-20 |

Chirurgische Scheren
Operating scissors

Ciseaux à chirurgie
Tijeras para cirugía
Forbici per chirurgia



GRAZIL

| | Fig. 1 | Fig. 2 | Fig. 3 |
|--------------|-------------------|-------------------|-------------------|
| 130 mm – 5" | tk 8043-13 | tk 8044-13 | tk 8045-13 |
| 145 mm – 5¾" | tk 8043-14 | tk 8044-14 | tk 8045-14 |



GRAZIL





| | Fig. 1 | Fig. 2 | Fig. 3 |
|--------------|-------------------|-------------------|-------------------|
| 130 mm – 5" | tk 8053-13 | tk 8054-13 | tk 8055-13 |
| 145 mm – 5¾" | tk 8053-14 | tk 8054-14 | tk 8055-14 |



Chirurgische Scheren
Operating scissors

Ciseaux à chirurgie
Tijeras para cirugía
Forbici per chirurgia



| DEAVER |  1:2 |  1:2 |  1:2 |  1:2 |
|--|---|---|---|---|
| 145 mm – 5 ³ / ₄ " | tk 8062-14 | tk 8063-14 | tk 8072-14 | tk 8073-14 |
| gerade <i>straight</i> | gebogen <i>curved</i> | gebogen, gezahnt <i>straight, saw edge</i> | gebogen, gezahnt <i>curved, saw edge</i> | |
| droits <i>recta</i> | courbes <i>curva</i> | droits, dentelés <i>recta, dentada</i> | courbes, dentelés <i>curva, dentada</i> | |
| rette | curve | rette, dentate | curve, dentate | |



| LANGE |  1:2 |  1:2 |  1:2 |  1:2 |
|--|---|---|---|---|
| 145 mm – 5 ³ / ₄ " | tk 8082-14 | tk 8083-14 | tk 8092-14 | tk 8093-14 |
| gerade <i>straight</i> | gebogen <i>curved</i> | gebogen, gezahnt <i>straight, saw edge</i> | gebogen, gezahnt <i>curved, saw edge</i> | |
| droits <i>recta</i> | courbes <i>curva</i> | droits, dentelés <i>recta, dentada</i> | courbes, dentelés <i>curva, dentada</i> | |
| rette | curve | rette, dentate | curve, dentate | |

Chirurgische Scheren
Operating scissors

Ciseaux à chirurgie
Tijeras para cirugía
Forbici per chirurgia



MIXTER

155 mm – 6"



tk 8102-15

gerade
straight
droits
recta
rette



tk 8112-15

gerade, gezahnt
straight, saw edge
droits, dentelés
recta, dentada
rette, dentate



tk 8103-15

gebogen
curved
courbes
curva
curve

tk 8113-15

gebogen, gezahnt
curved, saw edge
courbes, dentelés
curva, dentada
curve, dentate



LEXER

160 mm – 6 $\frac{1}{4}$ "

tk 8122-16

tk 8123-16

210 mm – 8 $\frac{1}{4}$ "

tk 8122-21

tk 8123-21



Chirurgische Scheren
Operating scissors

Ciseaux à chirurgie
Tijeras para cirugía
Forbici per chirurgia



RICHTER

140 mm – 5½"

tk 8142-14

1:2



FERGUSSON

140 mm – 5½"

tk 8152-14

160 mm – 6¼"

tk 8152-16

180 mm – 7"

tk 8152-18



130 mm – 5"

tk 8132-13

145 mm – 5¾"

tk 8132-14

Chirurgische Scheren – Präparierscheren
Operating scissors – Dissecting scissors

Ciseaux à chirurgie – Ciseaux à dissection
Tijeras para cirugía – Tijeras de disección
 Forbici per chirurgia – Forbici per dissezione

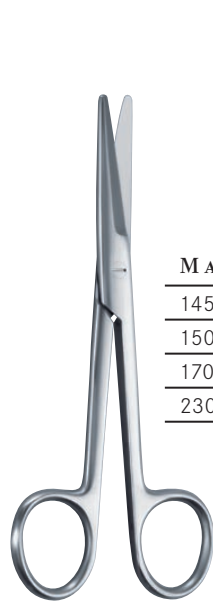

MAYO

| | | |
|--------------|-------------------|-------------------|
| 145 mm – 5¾" | tk 8272-14 | tk 8273-14 |
| 150 mm – 6" | tk 8272-15 | tk 8273-15 |
| 170 mm – 6¾" | tk 8272-17 | tk 8273-17 |
| 230 mm – 9" | tk 8272-23 | tk 8273-23 |

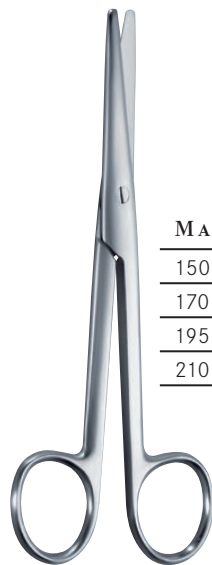

MAYO-STILLE

| | | |
|--------------|-------------------|-------------------|
| 150 mm – 6" | tk 8282-15 | tk 8283-15 |
| 170 mm – 6¾" | tk 8282-17 | tk 8283-17 |
| 195 mm – 7¾" | tk 8282-19 | tk 8283-19 |
| 210 mm – 8¾" | tk 8282-21 | tk 8283-21 |



Chirurgische Scheren – Präparierscheren
Operating scissors – Dissecting scissors

Ciseaux à chirurgie – Ciseaux à dissection
Tijeras para cirugía – Tijeras de disección
 Forbici per chirurgia – Forbici per dissezione



MAYO-HARRINGTON

220 mm – 8³/₄"



1:2



1:2

tk 8275-22

tk 8276-22



MAYO-NOBLE

170 mm – 6³/₄"



1:2



1:2

tk 8292-17

tk 8293-17

Chirurgische Scheren – Präparierscheren
Operating scissors – Dissecting scissors

Ciseaux à chirurgie – Ciseaux à dissection
Tijeras para cirugía – Tijeras de disección
 Forbici per chirurgia – Forbici per dissezione



WERTHEIM

| | |
|--------------|-------------------|
| 145 mm – 5¾" | tk 8295-14 |
| 225 mm – 8¾" | tk 8295-22 |

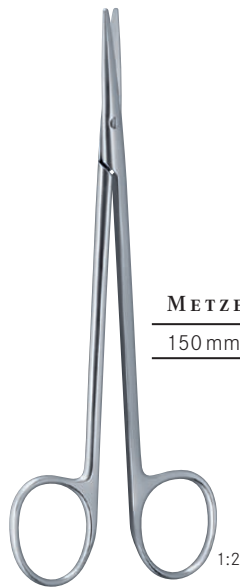

METZENBAUM

| | | |
|-------------|-------------------|-------------------|
| 150 mm – 6" | tk 8343-15 | tk 8353-15 |
|-------------|-------------------|-------------------|



1:2

1:2

1:2

Chirurgische Scheren – Präparierscheren
Operating scissors – Dissecting scissors

Ciseaux à chirurgie – Ciseaux à dissection
Tijeras para cirugía – Tijeras de disección
 Forbici per chirurgia – Forbici per dissezione



| METZENBAUM | Fig. 1 | Fig. 2 | Fig. 3 |
|--------------|-------------------|-------------------|-------------------|
| 115 mm – 4½" | tk 8323-11 | | |
| 145 mm – 5¾" | tk 8323-14 | tk 8324-14 | tk 8325-14 |



| METZENBAUM | Fig. 1 | Fig. 2 | Fig. 3 |
|--------------|-------------------|-------------------|-------------------|
| 115 mm – 4½" | tk 8333-11 | | |
| 145 mm – 5¾" | tk 8333-14 | tk 8334-14 | tk 8335-14 |

Chirurgische Scheren – Präparierscheren
Operating scissors – Dissecting scissors

Ciseaux à chirurgie – Ciseaux à dissection
Tijeras para cirugía – Tijeras de disección
 Forbici per chirurgia – Forbici per dissezione



METZENBAUM-
NELSON

| | Fig. 1 | Fig. 2 | Fig. 3 |
|--------------|-------------------|-------------------|-------------------|
| 180 mm – 7" | tk 8343-18 | tk 8344-18 | tk 8345-18 |
| 200 mm – 8" | tk 8343-20 | tk 8344-20 | tk 8345-20 |
| 230 mm – 9" | tk 8343-23 | tk 8344-23 | tk 8345-23 |
| 250 mm – 9¾" | tk 8343-25 | tk 8344-25 | tk 8345-25 |
| 280 mm – 11" | tk 8343-28 | tk 8344-28 | tk 8345-28 |
| 300 mm – 12" | tk 8343-30 | tk 8344-30 | tk 8345-30 |



METZENBAUM-
NELSON

| | Fig. 1 | Fig. 2 | Fig. 3 |
|--------------|-------------------|-------------------|-------------------|
| 180 mm – 7" | tk 8353-18 | tk 8354-18 | tk 8356-18 |
| 200 mm – 8" | tk 8353-20 | tk 8354-20 | tk 8356-20 |
| 230 mm – 9" | tk 8353-23 | tk 8354-23 | tk 8356-23 |
| 250 mm – 9¾" | tk 8353-25 | tk 8354-25 | tk 8356-25 |
| 280 mm – 11" | tk 8353-28 | tk 8354-28 | tk 8356-28 |
| 300 mm – 12" | tk 8353-30 | tk 8354-30 | tk 8356-30 |

Chirurgische Scheren – Präparierscheren
Operating scissors – Dissecting scissors

Ciseaux à chirurgie – Ciseaux à dissection
Tijeras para cirugía – Tijeras de disección
 Forbici per chirurgia – Forbici per dissezione



METZENBAUM-FINO



1:2



1:2



1:2



1:2

| | | | | |
|--------------|-------------------|-------------------|-------------------|-------------------|
| | Fig. 1 | Fig. 3 | Fig. 1 | Fig. 3 |
| 145 mm – 5¾" | tk 8372-14 | tk 8374-14 | tk 8373-14 | tk 8375-14 |

1:2



METZENBAUM-FINO



| | | | |
|-------------|-------------------|-------------------|-------------------|
| 180 mm – 7" | tk 8380-18 | tk 8381-18 | tk 8385-18 |
| 220 mm – 8" | tk 8380-20 | tk 8381-20 | tk 8385-20 |
| 230 mm – 9" | tk 8380-23 | tk 8381-23 | tk 8385-23 |

S-förmig gebogen
S-curved

courbes en S
curva en S
 curve a forma di S

Präparierscheren
Dissecting scissors

Ciseaux à dissection
Tijeras de disección
Forbici per dissezione



FOMON

135 mm – 5¼"

tk 8392-14



THOREK

190 mm – 7½"

tk 8394-19

Gynäkologische Scheren
Gynaecological scissors

Ciseaux à gynécologie
Tijeras para ginecología
Forbici per ginecologia



SIMS

| | Fig. 1 | Fig. 2 | Fig. 1 | Fig. 2 |
|-------------|-------------------|-------------------|-------------------|-------------------|
| 200 mm – 8" | tk 8423-20 | tk 8424-20 | tk 8433-20 | tk 8434-20 |
| 230 mm – 9" | tk 8423-23 | tk 8424-23 | tk 8433-23 | tk 8434-23 |

Gynäkologische Scheren
Gynaecological scissors

Ciseaux à gynécologie
Tijeras para ginecología
Forbici per ginecologia



1:2

DUBOIS

270 mm – 10¾"



1:2

tk 8442-27



1:2

tk 8443-27



1:2

DOYEN

175 mm – 7"



1:2

tk 8452-17



1:2

tk 8453-17



1:2

SIEBOLD

240 mm – 9½"

tk 8477-24

S-förmig gebogen
S-curved

courbes en S

curva en S

curve a forma di S

Feine chirurgische Scheren
Fine operating scissors

Ciseaux fins à chirurgie
Tijeras finas para cirugía
Forbici fine per chirurgia

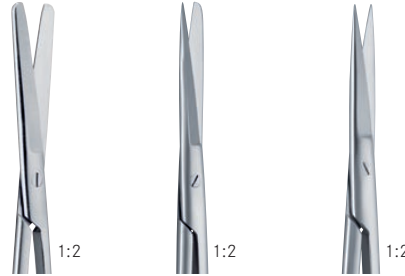

| | Fig. 1 | Fig. 2 | Fig. 3 |
|--------------|-------------------|-------------------|-------------------|
| 120 mm – 4¾" | tk 8523-12 | tk 8524-12 | tk 8525-12 |

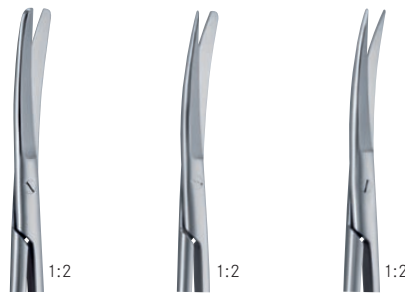

| | Fig. 1 | Fig. 2 | Fig. 3 |
|--------------|-------------------|-------------------|-------------------|
| 120 mm – 4¾" | tk 8533-12 | tk 8534-12 | tk 8535-12 |

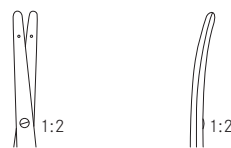

KNAPP

| | | |
|--------------|-------------------|-------------------|
| 105 mm – 4¼" | tk 8688-10 | tk 8689-10 |
|--------------|-------------------|-------------------|

stumpf

blunt

mousses

roma

smusse

1:2

Feine Scheren
Fine scissors

Ciseaux fins
Tijeras finas
Forbici fini



WAGNER

120 mm – 4³/₄ "



1:2

tk 8542-12

gerade
straight
droits
recta
rette



1:2

tk 8552-12

gerade, gezahnt
straight, saw edge
droits, dentelés
recta, dentada
rette, dentate



tk 8543-12

gebogen
curved
courbes
curva
curve

tk 8553-12

gebogen, gezahnt
curved, saw edge
courbes, dentelés
curva, dentada
curve, dentate



BROPHY
(SULLIVAN)

145 mm – 5³/₄ "



1:2

tk 8572-14



1:2

tk 8573-14



LITTLER

115 mm – 4¹/₂ "



1:2

tk 8571-11

145 mm – 5³/₄ "

tk 8571-14

Feine Scheren | Ciseaux fins
Fine scissors | Tijeras finas
Forbici fini



LOCKLIN

165 mm – 6½"

tk 8582-16



tk 8587-16



QUINBY

125 mm – 5"

tk 8592-12

gezahnt
saw edge,
dentelées
dentada
dentate



REYNOLDS

160 mm – 6¼"

tk 8602-16



tk 8603-16

180 mm – 7"

tk 8602-18

tk 8603-18



NEUMANN

120 mm – 4¾"

tk 8597-12

S-förmig gebogen
S-curved

courbes en S
curva en S
curve a forma di S

Feine Scheren
Fine scissors

Ciseaux fins
Tijeras finas
Forbici fini



105 mm – 4 1/4"



1:2

tk 8622-10



1:2

tk 8623-10

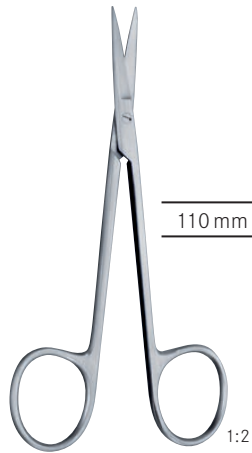

110 mm – 7"



1:2

tk 8632-11



1:2

tk 8633-11



90 mm – 3 1/2"



1:2

tk 8642-09



1:2

tk 8643-09

Feine Scheren
Fine scissors

Ciseaux fins
Tijeras finas
Forbici fini



| | | |
|--------------|-------------------|-------------------|
| 90 mm – 3½" | tk 8652-09 | tk 8653-09 |
| 100 mm – 4" | tk 8652-10 | tk 8653-10 |
| 115 mm – 4½" | tk 8652-11 | tk 8653-11 |



| | | |
|------------------|-------------------|-------------------|
| SANVENERO | 1:2 | 1:2 |
| 145 mm – 5¾" | tk 8662-14 | tk 8663-14 |

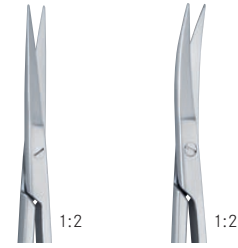

LEXER-BABY

100 mm – 4"



gerade
straight
droits
recta
rette

tk 8672-10

gerade, gezahnt
straight, saw edge
droits, dentelés
recta, dentada
rette, dentate



gebogen
curved
courbes
curva
curve

tk 8682-10

tk 8673-10

gebogen, gezahnt
curved, saw edge
courbes, dentelés
curva, dentad
curve, dentate

tk 8683-10

Fistelscheren
Fistula scissors

Ciseaux pour fistules
Tijeras para fistulas
Forbici per fistole



KELLY

| | | |
|--------------|-------------------|-------------------|
| 160 mm – 6¼" | tk 8462-16 | tk 8463-16 |
| 180 mm – 7" | tk 8462-18 | tk 8463-18 |

Enucleationsscheren
Enucleation scissors

Ciseaux à énucléation
Tijeras para enucleación
Forbici per enucleazione

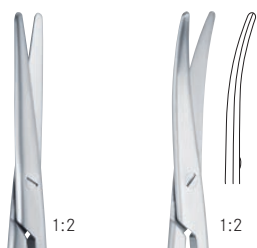

LANDOLDT

| | | |
|-------------|-------------------|-------------------|
| 125 mm – 5" | tk 8612-12 | tk 8614-12 |
|-------------|-------------------|-------------------|



CHADWICK

| | | |
|--------------|-------------------|-------------------|
| 110 mm – 4¼" | tk 9485-11 | tk 9492-11 |
|--------------|-------------------|-------------------|

Scheren für die Plastische Chirurgie
Plastic surgery scissors

Ciseaux pour la chirurgie plastique
Tijeras para cirugía plástica
 Forbici per chirurgia plastica



JOSEPH

140 mm – 5½"



1:2



1:2

tk 8692-14

tk 8693-14



KILNER (RAGNELL)

120 mm – 4¾"



1:2

tk 8697-12

150 mm – 6"

tk 8697-15



GORNEY

200 mm – 8"

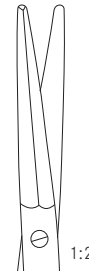

1:2

tk 8700-20

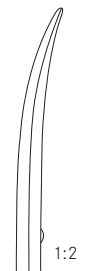

1:2

tk 8701-20



Bitte fordern Sie unseren Spezialkatalog für Plastische Chirurgie an.
Please ask for our special catalogue for plastic surgery.

Veuillez demander pour notre catalogue spécial pour la chirurgie plastique.
Por favor preguntan para el catalogo especial para la cirugía plástica.

Per favore domandate per il nostro catalogo speciale per la chirurgia plastica.

Gefäßscheren
Artery scissors

Ciseaux vasculaires
Tijeras vasculares
Forbici vascolari



1:2

145 mm – 5¾"

tk 8722-14

- 1 Blatt mit Sondenspitze
- 1 Blade with probe
- 1 Lame avec sonde
- 1 Punta forma sonda
- 1 Lama con sonda



1:2

LINCOLN

170 mm – 6¾"



1:2

tk 8724-17



1:2

tk 8725-17



1:2

115 mm – 4½"

tk 8727-11



1:2

FULTON

170 mm – 6¾"

tk 8730-17

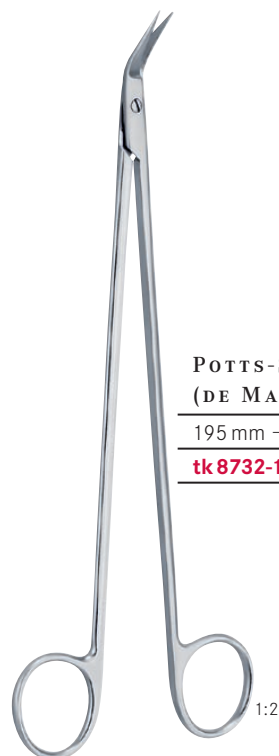

1:2

POTTS-SMITH
(DE MARTEL)

195 mm – 7¾"

tk 8732-19

Gefäßscheren
Artery scissors

Ciseaux vasculaires
Tijeras vasculares
Forbici vascolari



FAVALORO
150 mm – 6"
tk 8740-15

1:2



DE BAKEY
155 mm – 6" **tk 8741-15** **tk 8742-15**

Offset-Schere, S-förmig
Offset scissors, s-shaped
Ciseaux offset, courbes en S
Tijera offset, curva en S
Forbici offset, curve a forma di S

1:2

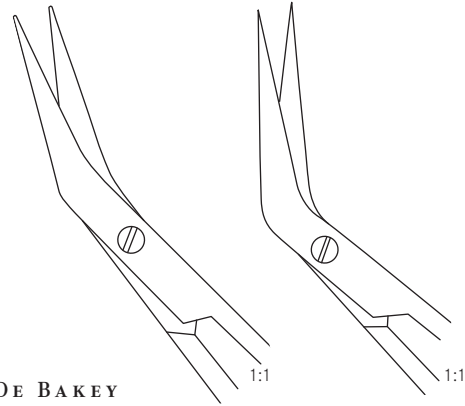

| DE BAKEY | 25° | 45° | 60° |
|--|-------------------|-------------------|-------------------|
| 160 mm – 6 ³ / ₄ " | tk 8745-16 | tk 8746-16 | tk 8747-16 |
| 230 mm – 9" | tk 8745-23 | tk 8746-23 | tk 8747-23 |
| 280 mm – 11" | tk 8745-28 | tk 8746-28 | tk 8747-28 |

1:2



MILLS
225 mm – 8³/₄"
tk 8744-22

1:2

Gefäßscheren
Artery scissors

Ciseaux vasculaires
Tijeras vasculares
Forbici vascolari

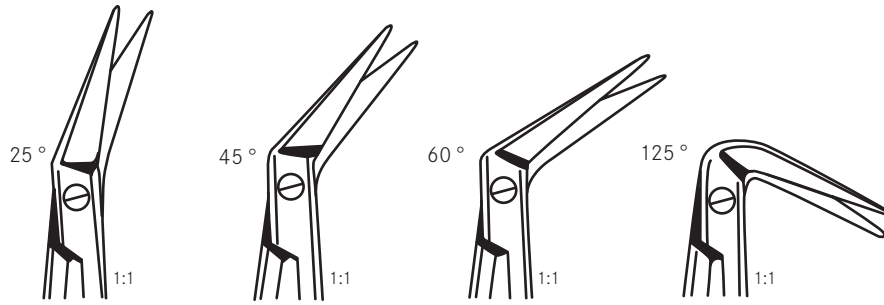

POTTS-DE
MARTEL

190 mm – 7½"

tk 8771-25

tk 8771-45

tk 8771-60

tk 8771-12

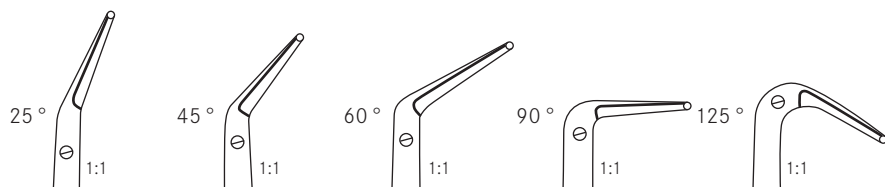

180 mm – 7"

tk 8772-25

tk 8772-45

tk 8772-60

tk 8772-90

tk 8772-12

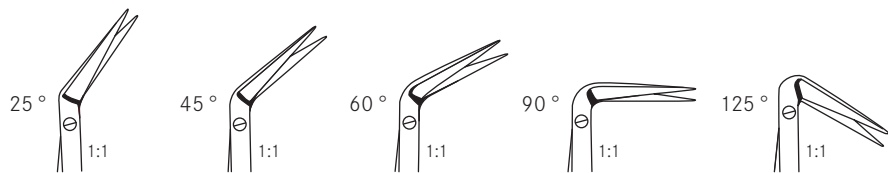

tk 8774-25

tk 8774-45

tk 8774-60

tk 8774-90

tk 8774-12

1:2

Gefäßscheren
Artery scissors

Ciseaux vasculaires
Tijeras vasculares
Forbici vascolari

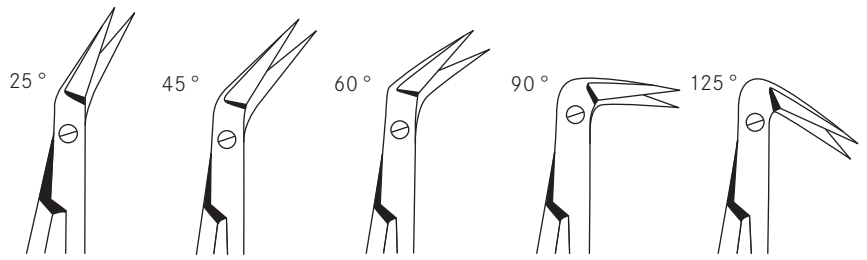

DIETRICH-
HEGEMANN

| | | | | | |
|--------------|-------------------|-------------------|-------------------|-------------------|-------------------|
| 145 mm – 5¾" | tk 8754-14 | tk 8755-14 | tk 8756-14 | tk 8757-14 | tk 8758-14 |
| 160 mm – 6¼" | tk 8754-16 | tk 8755-16 | tk 8756-16 | tk 8757-16 | tk 8758-16 |
| 190 mm – 7½" | tk 8754-19 | tk 8755-19 | tk 8756-19 | tk 8757-19 | tk 8758-19 |

Knorpelscheren
Cartilage scissors

Ciseaux pour cartilages
Tijeras para cartilagos
 Forbici per cartilagini



MARTIN-CARTILAGE

190 mm – 7½" tk 8747-19

gebogen, gezahnt
curved, saw edge

courbes, dentelés
curva, dentada
 curve, dentate



MC INDOE

190 mm – 7½" tk 8752-19



POTTS-SMITH

190 mm – 7½" tk 8753-19

Tonsillenscheren
Tonsil scissors

Ciseaux pour amygdales
Tijeras para amigdales
Forbici per tonsille



BOETTCHER

180 mm – 7"

tk 8832-18



PRINCE

175 mm – 7"

tk 8837-17



TOENNIS-ADSON

170 mm – 6³/₄"

tk 8847-17



TOENNIS

180 mm – 7"



1:1

tk 8842-18



1:1

tk 8843-18

Tonsillenscheren
Tonsil scissors

Ciseaux pour amygdales
Tijeras para amigdales
Forbici per tonsille



DEAN

170 cm – 6¾"

tk8852-17

tk8857-17

gebogen
curved

courbes
curva

curve

gebogen, gezahnt
curved, saw edge

courbes, dentelés
curva, dentada

curve, dentate

1:2



WERTHEIM

190 mm – 7½"

tk8862-19

1:2



OLIVECRONA

230 mm – 9"

tk8849-23

Trigeminusschere
Trigeminal scissors

Ciseaux pour le trigéminus
Tijera para nervio trigémino
Forbici per il nervo trigemino

1:2



GOOD

190 mm – 7½"

tk8867-19

1:2

Lungenscheren
Lobectomy scissors

Ciseaux à lobectomie
Tijeras para lobectomia
Forbici per lobectomia



CRAFOORD

| | |
|--------------|-------------------|
| 300 mm – 12" | tk 8882-30 |
|--------------|-------------------|

1:3

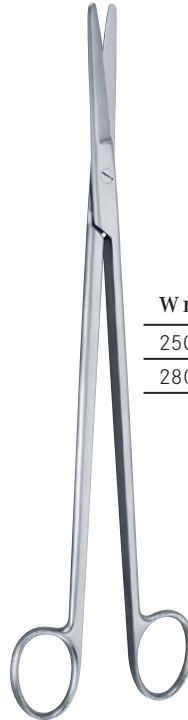

WILLAUER

| | | |
|--------------|-------------------|-------------------|
| 250 mm – 9¾" | tk 8892-25 | tk 8893-25 |
| 280 mm – 11" | tk 8892-28 | tk 8893-28 |

gerade
straight

droits
recta
rette

gebogen
curved

courbes
curva
curve



FINOCHIETTO

| | |
|---------------|-------------------|
| 270 mm – 10¾" | tk 8912-27 |
|---------------|-------------------|

1:3



RESANO

| | |
|--------------|-------------------|
| 250 mm – 10" | tk 8939-25 |
|--------------|-------------------|

1:3

Thoraxscheren
Thorax scissors

Ciseaux pour le thorax
Tijeras para torax
Forbici per torace



SATINSKY

245 mm – 9¾"

tk 8762-24



KLINKENBERG-LOTH

230 mm – 9"

tk 8767-23



JORGENSEN

220 mm – 8¾"

tk 8769-22

Darmscheren
Enterotomy scissors

Ciseaux pour l'intestin
Tijeras para intestino
Forbici per enterotomia



| | | | |
|-----------------|-------------------|-------------------|-------------------|
| | Fig. 1 | Fig. 2 | Fig. 3 |
| 210 mm – 8 1/4" | tk 8922-21 | tk 8927-21 | tk 8932-21 |

Nabelschnurscheren
Umbilical scissors

Ciseaux pour le cordon ombilical
Tijeras umbilicales
 Forbici ombelicali



BUSCH

| | | |
|--------------|-------------------|-------------------|
| 130 mm – 5" | tk 9022-13 | tk 9027-13 |
| 160 mm – 6¼" | tk 9022-16 | tk 9027-16 |

gezahnt
saw edge
 dentelés
dentada
 dentate



SCHUMACHER

| | |
|--------------|-------------------|
| 160 mm – 6¼" | tk 9032-16 |
|--------------|-------------------|



MOD. USA

| | |
|--------------|-------------------|
| 105 mm – 4¼" | tk 9042-10 |
|--------------|-------------------|

Episiotomiescheren
Episiotomy scissors

Ciseaux à épisiotomie
Tijeras para episiotomia
Forbici per episiotomia



BRAUN-STADLER

| | |
|--------------|-------------------|
| 145 mm – 5¾" | tk 9072-14 |
| 220 mm – 8¾" | tk 9077-22 |



WALDMANN

| | |
|-------------|-------------------|
| 180 mm – 7" | tk 9107-18 |
|-------------|-------------------|

1:2

Parametriumscheren
Parametrium scissors

Parametrium ciseaux
Parametrium tijeras
 Forbici per il parametrio

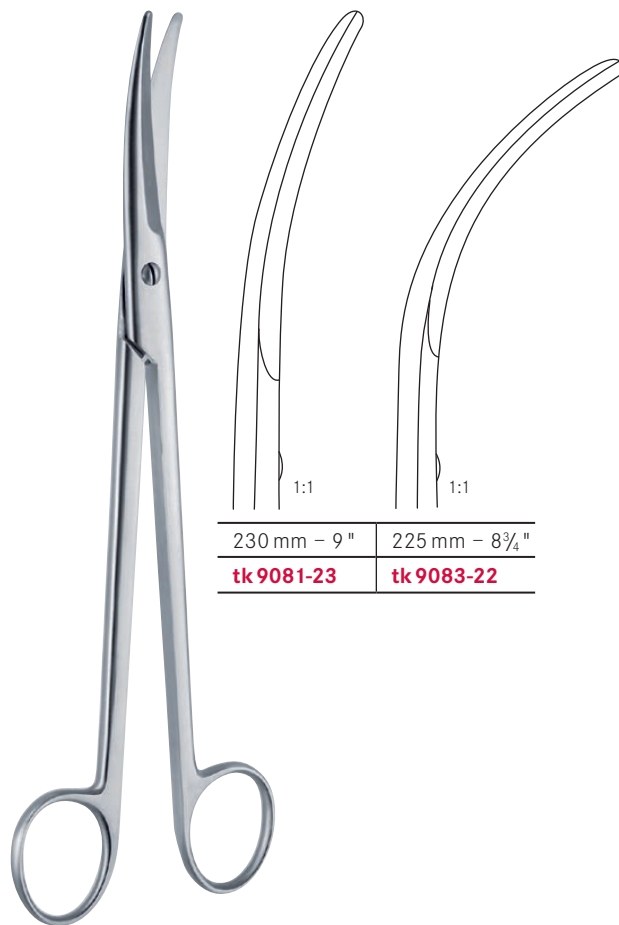

Nasenscheren
Nasal scissors

Ciseaux nasaux
Tijeras nasales
Forbici nasali



SAILER

170 mm – 6³/₄"

tk 9132-17



HEYMANN

180 mm – 7"

tk 9137-18



FOMON

130 mm – 5"

tk 9152-13



COTTLE



160 mm – 6¹/₄"

tk 9157-16

Mikroscheren | Micro-ciseaux
 Micro scissors | Micro-tijeras
 Micro-forbici





1:1

| NOYES |  1:1 |  1:1 |  1:1 |
|----------------------------------|---|---|---|
| | Fig. 1 | Fig. 2 | Fig. 3 |
| 120 mm – 4 3/4" | tk 9222-01 | tk 9222-02 | tk 9222-03 |
| gerade straight | spitz – spitz sharp – sharp | spitz – stumpf sharp – blunt | stumpf – stumpf blunt – blunt |
| droits <i>recta</i> rette | pointue – pointue <i>roma – roma</i> acuta – acuta | pointue – mousse <i>roma – aguda</i> acuta – smussa | mousse – mousse <i>aguda – aguda</i> smussa – smussa |



1:1

| NOYES |  1:1 |  1:1 |  1:1 |
|--|---|---|---|
| | Fig. 1 | Fig. 2 | Fig. 3 |
| 120 mm – 4 3/4" | tk 9223-01 | tk 9223-02 | tk 9223-03 |
| abgewinkelt angulated | spitz – spitz sharp – sharp | spitz – stumpf sharp – blunt | stumpf – stumpf blunt – blunt |
| coudé <i>angulado</i> angolate | pointue – pointue <i>roma – roma</i> acuta – acuta | pointue – mousse <i>roma – aguda</i> acuta – smussa | mousse – mousse <i>aguda – aguda</i> smussa – smussa |

Mikroscheren
Micro scissors

Micro-ciseaux
Micro-tijeras
Micro-forbici



120 mm – 4 3/4" **tk 9230-12**

1:1



BARRAQUER

| | |
|-----------|-------------------|
| | 55 mm – 2 1/4" |
| x = 7 mm | tk 9252-05 |
| x = 10 mm | tk 9257-05 |

1:1



1:1

WECKER

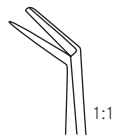

1:1

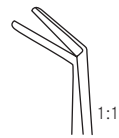

1:1

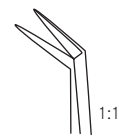

1:1

| | Fig. 1 | Fig. 2 | Fig. 3 |
|-----------------|-------------------|-------------------|-------------------|
| 110 mm – 4 1/4" | tk 9243-11 | tk 9244-11 | tk 9245-11 |

spitz – stumpf
sharp – blunt

stumpf – stumpf
blunt – blunt

spitz – spitz
sharp – sharp

pointue – mousse

mousse – mousse

pointue – pointue

roma – aguda

aguda – aguda

roma – roma

acuta – smussa

smussa – smussa

acuta – acuta

Mikroscheren | Micro-ciseaux
 Micro scissors | Micro-tijeras
 | Micro-forbici



WESTCOTT

115 mm – 4½"



1:1

tk 9262-11



1:1

tk 9263-11



CASTROVIEJO

90 mm – 3½"

tk 9272-09

1:1

Mikroscheren
Micro scissors

Micro-ciseaux
Micro-tijeras
Micro-forbici



VANNAS

80 mm – 3¼"



1:1

tk 9282-08



1:1

tk 9283-08

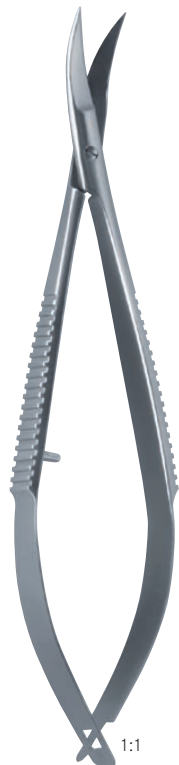

CASTROVIEJO

100 mm – 4"



1:1

tk 9322-10



1:1

tk 9332-10

spitz – spitz stumpf – stumpf
sharp – sharp blunt – blunt

pointue – pointue mousse – mousse

aguda – aguda roma – roma

acuta – acuta smussa – smussa

Sehnenscheren
Tenotomy scissors

Ciseaux à ténatomie
Tijeras para tenotomía
Forbici per tenotomia

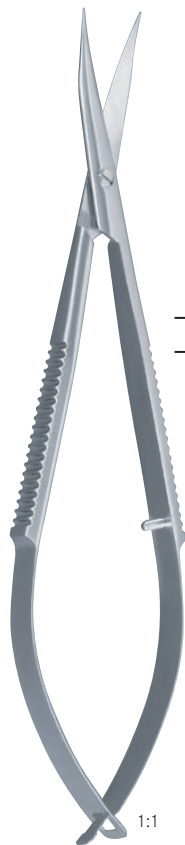

WESTCOTT

110 mm – 4¼"



1:1

tk 9352-11

spitz – spitz
sharp – sharp

pointue – pointue
aguda – aguda
acuta – acuta



1:1

tk 9357-11

stumpf – stumpf
blunt – blunt

mousse – mousse
roma – roma
smussa – smussa

Irisscheren
Iris scissors

Ciseaux à iridectomie
Tijeras para iridectomia
Forbici per iridectomia

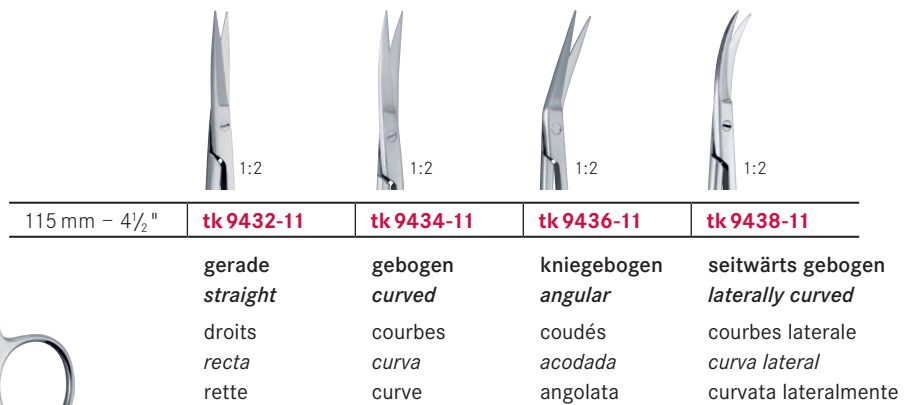
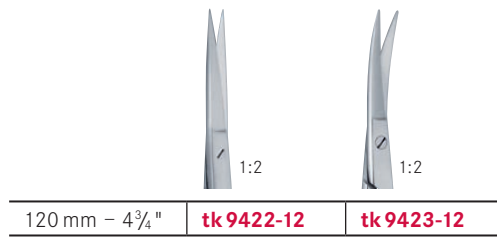

Sehnenscheren
Tenotomy scissors

Ciseaux à ténatomie
Tijeras para tenotomía
Forbici per tenotomia

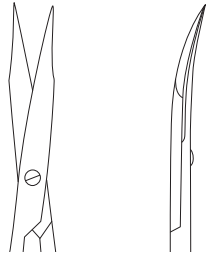

STEVENS

| | | |
|--------------|-------------------|-------------------|
| 100 mm – 4" | tk 9452-10 | tk 9453-10 |
| 110 mm – 4¼" | tk 9452-11 | tk 9453-11 |

spitz – spitz
sharp – sharp
pointue – pointue
aguda – aguda
acuta – acuta

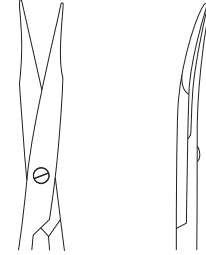
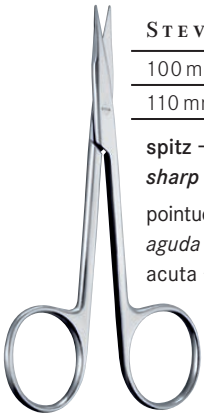

STEVENS

| | | |
|--------------|-------------------|-------------------|
| 100 mm – 4" | tk 9462-10 | tk 9463-10 |
| 110 mm – 4¼" | tk 9462-11 | tk 9463-11 |

stumpf – stumpf
blunt – blunt
mousse – mousse
roma – roma
smussa – smussa

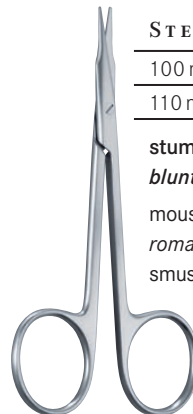

WALTON

| | |
|-------------|-------------------|
| 100 mm – 4" | tk 9473-10 |
|-------------|-------------------|



1:2

GRAEFE

| | |
|--------------|-------------------|
| 105 mm – 4¼" | tk 9477-09 |
|--------------|-------------------|



1:2

Strabismusscheren
Strabismus scissors

Ciseaux à strabisme
Tijeras para estrabismo
Forbici per strabismo

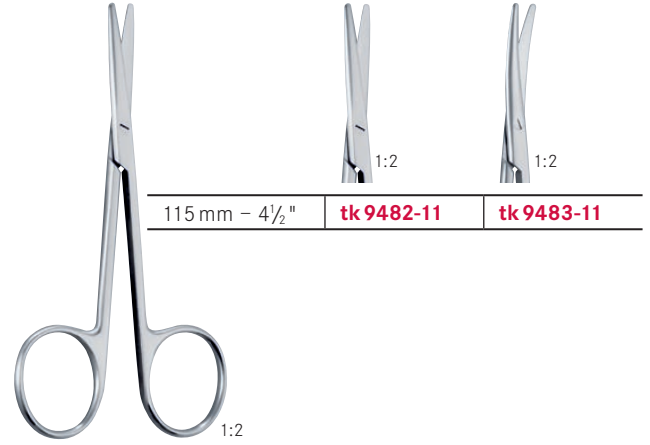
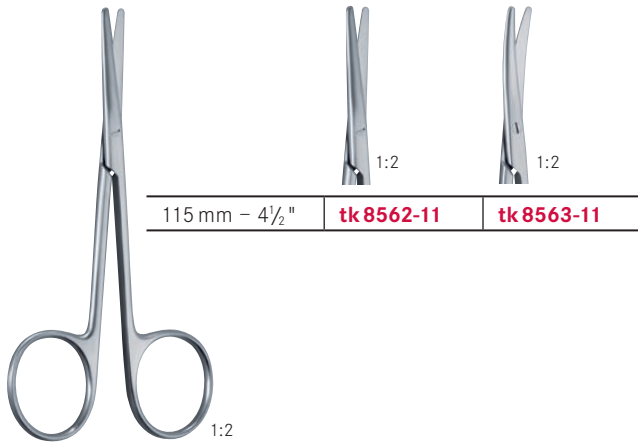

Anatomische Scheren
Anatomy scissors

Ciseaux à dissequer
Tijeras para anatomia
Forbici per anatomia



| | | |
|--------------|-------------------|-------------------|
| 115 mm – 4½" | tk 9502-11 | tk 9503-11 |
| 130 mm – 5" | tk 9502-13 | tk 9503-13 |
| 140 mm – 5½" | tk 9502-14 | tk 9503-14 |

Durascheren
Dura scissors

Ciseaux pour la duremère
Tijeras para dura-madre
Forbici per dura-madre



TAYLOR

145 mm – 5¾"

tk 9517-14

1:2

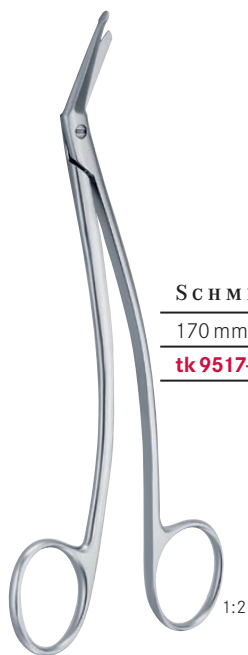

SCHMIEDEN

170 mm – 6¾"

tk 9517-17

1:2



DANDY

170 mm – 6¾"

tk 9521-17

1:2



STRULLY

220 mm – 8¾"

1:2



1:2



1:2

tk 9518-22

tk 9519-22

Ligaturscheren
Ligature scissors

Ciseaux à ligatures
Tijeras para ligaduras
Forbici per sutura



LITTAUER

140 mm – 5½"

tk 9522-14

1:2



O'BRIEN

90 mm – 3½"

tk 9530-09

1:2

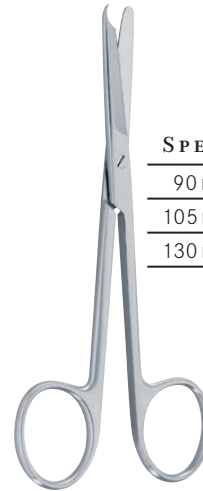

SPENCER

90 mm – 3½"

tk 9532-09

105 mm – 4¼"

tk 9532-10

130 mm – 5"

tk 9532-13



115 mm – 4½"

tk 9533-11

1:2

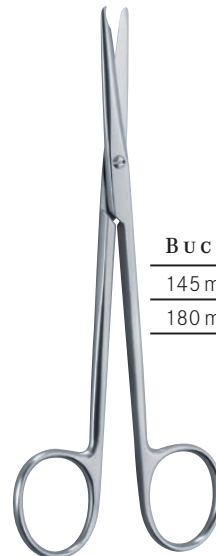

BUCK

145 mm – 5¾"

tk 9535-14

180 mm – 7"

tk 9535-18

Ligaturscheren
Ligature scissors

Ciseaux à ligatures
Tijeras para ligaduras
Forbici per sutura



NORTHBENT

| | |
|-------------|-------------------|
| 90 mm – 3½" | tk 9542-09 |
| 125 mm – 5" | tk 9542-12 |



HEATH

| | |
|-------------|-------------------|
| 150 mm – 6" | tk 9552-15 |
|-------------|-------------------|

gezahnt
saw edge
dentelés
dentada
dentata

1:2



| | |
|--------------|-------------------|
| 120 mm – 4¾" | tk 9557-12 |
|--------------|-------------------|

gezahnt
saw edge
dentelés
dentada
dentata

1:2



EISELSBERG

| | |
|--------------|-------------------|
| 110 mm – 4¼" | tk 9567-11 |
|--------------|-------------------|

1:2



| | |
|--------------|-------------------|
| 105 mm – 4¼" | tk 9577-10 |
|--------------|-------------------|

1:2

Drahtscheren | Cisailles pour fils
Wire cutting scissors | Cizallas para cortar alambre
 Forbici per filo metallico

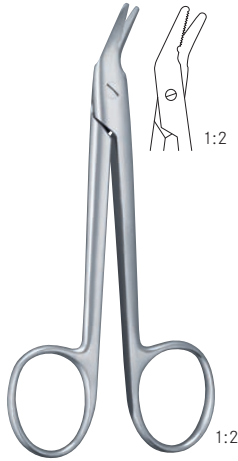

UNIVERSAL

120 mm – 4¾"

tk 9622-12

gezahnt
saw edge
 dentelés
dentada
 dentata



HARVEY

125 mm – 5"

tk 9632-12

gezahnt
saw edge
 dentelés
dentada
 dentata



SCHUHKNECHT

125 mm – 5"

tk 9637-12

gezahnt
saw edge
 dentelés
dentada
 dentata

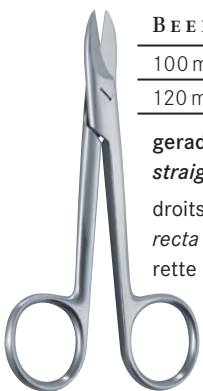

BEEBEE

100 mm – 4"

120 mm – 4¾"

gerade
straight
 droits
recta
 rette

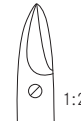
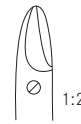

tk 9582-10

tk 9582-12

tk 9592-10

tk 9592-12

tk 9602-10

tk 9602-12

tk 9612-10

tk 9612-12

stumpf – stumpf
blunt – blunt

spitz – spitz
sharp – sharp

stumpf – stumpf, gezahnt
blunt – blunt, saw edge

spitz – spitz, gezahnt
sharp – sharp, saw edge

mousse – mousse
roma – roma

pointue – pointue
aguda – aguda

mousse – mousse, dentelée
roma – roma, dentada

pointue – pointue, dentelée
aguda – aguda, dentada

smussa – smussa

acuta – acuta

smussa – smussa, dentata

acuta – acuta, dentata

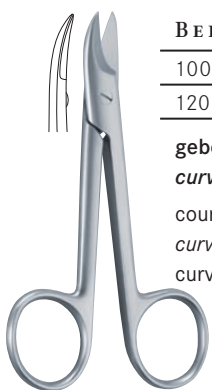

BEEBEE

100 mm – 4"

120 mm – 4¾"

gebogen
curved
 courbes
curva
 curve

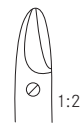
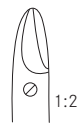

tk 9583-10

tk 9583-12

tk 9593-10

tk 9593-12

tk 9603-10

tk 9603-12

tk 9613-10

tk 9613-12

stumpf – stumpf
blunt – blunt

spitz – spitz
sharp – sharp

stumpf – stumpf, gezahnt
blunt – blunt, saw edge

spitz – spitz, gezahnt
sharp – sharp, saw edge

mousse – mousse
roma – roma

pointue – pointue
aguda – aguda

mousse – mousse, dentelée
roma – roma, dentada

pointue – pointue, dentelée
aguda – aguda, dentada

smussa – smussa

acuta – acuta

smussa – smussa, dentata

acuta – acuta, dentata

Verbandscheren | Ciseaux pour pansements
 Bandage scissors | Tijeras para vendajes
 Forbici per bendaggi



UNIVERSAL

| | |
|-------------|-------------------|
| 150 mm – 6" | tk 9670-15 |
| 180 mm – 7" | tk 9670-18 |



LISTER

| | |
|--------------|-------------------|
| 90 mm – 3½" | tk 9672-09 |
| 110 mm – 4¼" | tk 9672-11 |
| 140 mm – 5½" | tk 9672-14 |
| 180 mm – 7" | tk 9672-18 |
| 200 mm – 8" | tk 9672-20 |



| | |
|-------------|-------------------|
| 180 mm – 7" | tk 9674-18 |
| 200 mm – 8" | tk 9674-20 |

Verbandscheren
Bandage scissors

Ciseaux pour pansements
Tijeras para vendajes
Cesoie per bendaggi



LANGE

180 mm – 7"

tk 9697-18

1:2



KNOWLES

140 mm – 5½"

tk 9727-14

1:2



160 mm – 6¼"

tk 9702-16

1:2

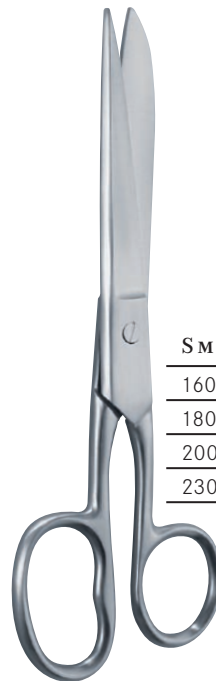

SMITH (MOD. USA)

160 mm – 6¼"

tk 9722-16

180 mm – 7"

tk 9722-18

200 mm – 8"

tk 9722-20

230 mm – 9"

tk 9722-23

Verband- und Gippscheren
Bandage scissors – Plaster shears

Ciseaux pour pansements et plâtres
Tijeras para vendajes y vendajes enyesados
 Cesioie per bendaggi ed apparecchi gessati



ESMARCH

| | |
|--------------|-------------------|
| 200 mm – 8" | tk 9676-20 |
| 220 mm – 8¾" | tk 9676-22 |



EXCENTRIC

| | |
|--------------|-------------------|
| 160 mm – 6¼" | tk 9680-16 |
| 190 mm – 7½" | tk 9680-19 |

gezahnt
saw edge
 dentelés
dentadas
 dentate



BERGMANN

| | |
|-------------|-------------------|
| 230 mm – 9" | tk 9682-23 |
|-------------|-------------------|

1:2



LORENZ

| | |
|-------------|-------------------|
| 230 mm – 9" | tk 9687-23 |
|-------------|-------------------|

1:2

Gipsscheren
Plaster shears

Cisailles pour plâtres
Cizallas para vendajes enyesados
Cesoie per apparecchi gessati

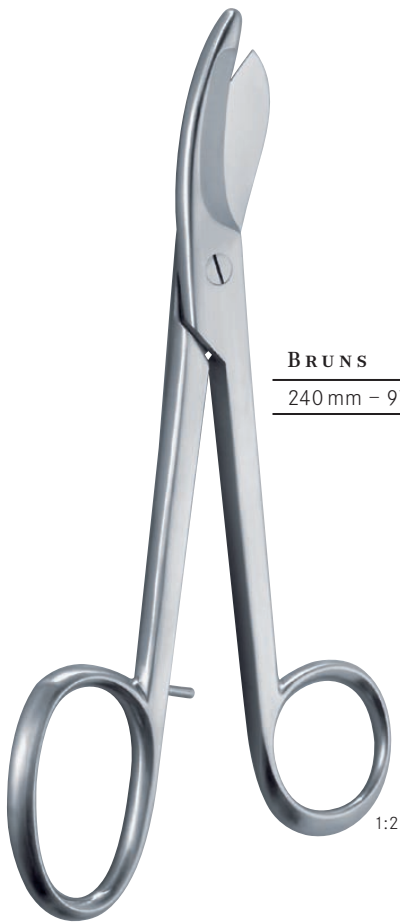

BRUNS

240 mm – 9½"



1:2



1:2

tk 9712-24

tk 9714-24

gezahnt
saw edge
dentelés
dentadas
dentate

1:2



1:2

200 mm – 8"

tk 9732-20



1:2

230 mm – 9"

tk 9737-23

Hautscheren – Nagelscheren
Cuticle scissors – Nail scissors

Ciseaux à envies – Ciseaux à ongles
Tijeras cuticulares – Tijeras para uñas
 Forbici per unghie e cuticole



| | | |
|--------------|-------------------|-------------------|
| 100 mm – 4" | tk 9982-10 | tk 9983-10 |
| 110 mm – 4¼" | tk 9982-11 | tk 9983-11 |



| | | |
|--------------|-------------------|-------------------|
| 90 mm – 3½" | tk 9992-09 | tk 9993-09 |
| 100 mm – 4" | tk 9992-10 | tk 9993-10 |
| 110 mm – 4¼" | tk 9992-11 | tk 9993-11 |



Nagelspaltscheren
Nail splitting scissors

Ciseaux à ongles
Tijeras para uñas
 Forbici per unghie



| | |
|-------------|-------------------|
| 130 mm – 5" | tk 9642-13 |
| 150 mm – 6" | tk 9642-15 |



| | | |
|-------------|-------------------|-------------------|
| SYSTRUNK | | |
| 130 mm – 5" | tk 9652-13 | tk 9653-13 |

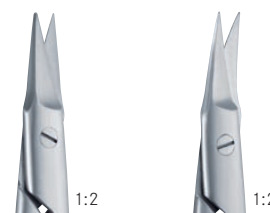

Nagelzangen
Nail nippers

Pinces à ongles
Pinzas corta-uñas
Forbici e tronchesine per unghie



| | |
|-----------------|-------------------|
| 110 mm – 4 1/4" | tk 9974-11 |
| 130 mm – 5" | tk 9974-13 |
| 150 mm – 6" | tk 9974-15 |



| | |
|-----------------|-------------------|
| 140 mm – 5 1/2" | tk 9976-14 |
|-----------------|-------------------|



| | |
|-----------------|-------------------|
| 140 mm – 5 1/2" | tk 9977-14 |
|-----------------|-------------------|



TURNBULL

| | |
|-----------------|-------------------|
| 115 mm – 4 1/2" | tk 9978-11 |
| 130 mm – 5" | tk 9978-13 |



| | |
|-------------|-------------------|
| 100 mm – 4" | tk 9960-10 |
|-------------|-------------------|



COHEN

| | |
|-------------|-------------------|
| 100 mm – 4" | tk 9962-10 |
|-------------|-------------------|

TUCAR^{TK}

Scheren mit Hartmetallschneiden *Scissors with tungsten-carbide inserts*

Ciseaux avec inserts de carbure de tungstène
Tijeras con filo en carburo de tungsteno
Forbici con inserti al carburo di tungsteno



Alle Scheren mit „tucar“ Hartmetallschneiden zeichnen sich durch eine über lange Zeit gleichmäßige weiche und dauerhafte Schnittfähigkeit aus. Alle Scheren mit Hartmetallschneiden haben zur Kennzeichnung vergoldete Ringe.

All scissors with “tucar” tungsten carbide cutting edges are distinguished by a uniform, smooth and longlasting cut. Scissors having tungsten carbide cutting edges are identified by gold plated rings

Tous les ciseaux munis de lames «tucar» en carbure de tungstène se distinguent par leur coupe uniforme, souple et durable. Les ciseaux avec tranchants en carbure de tungstène se reconnaissent par leurs anneaux dorés.

Todas las tijeras dotadas de hojas “tucar” de carburo de tungsteno son distinguidas por su corte uniforme, suave y durable. Tijeras con corte de carburo de tungsteno se reconocen por la doradura de sus anillos.

Tutte le forbici con taglio di tungsteno permettono un taglio uniforme per un tempo prolungato. Tutte le forbici “tucar”, cioè con le lame di Tungsteno hanno gli anelli d’orati.

Chirurgische Scheren
Operating scissors

Ciseaux à chirurgie
Tijeras para cirugía
Forbici per chirurgia

TUCARTK



STANDARD

| | Fig. 1 | Fig. 2 | Fig. 3 |
|--------------|-------------------|-------------------|-------------------|
| 145 mm – 5¾" | tk 8027-14 | tk 8028-14 | tk 8029-14 |
| 165 mm – 6½" | tk 8027-16 | tk 8028-16 | tk 8029-16 |



STANDARD

| | Fig. 1 | Fig. 2 | Fig. 3 |
|--------------|-------------------|-------------------|-------------------|
| 145 mm – 5¾" | tk 8037-14 | tk 8038-14 | tk 8039-14 |
| 165 mm – 6½" | tk 8037-16 | tk 8038-16 | tk 8039-16 |



LEXER

| | | |
|--------------|-------------------|-------------------|
| 165 mm – 6½" | tk 8138-16 | tk 8139-16 |
| 210 mm – 8¼" | tk 8138-21 | tk 8139-21 |

Chirurgische Scheren – Präparierscheren
Operating scissors – Dissecting scissors

Ciseaux à chirurgie – Ciseaux à dissection
Tijeras para cirugía – Tijeras de disección
 Forbici per chirurgia – Forbici per dissezione



MAYO



| | | |
|--------------|-------------------|-------------------|
| 145 mm – 5¾" | tk 8278-14 | tk 8279-14 |
| 170 mm – 6¾" | tk 8278-17 | tk 8279-17 |
| 230 mm – 9" | tk 8278-23 | tk 8279-23 |



MAYO-STILLE



| | | |
|--------------|-------------------|-------------------|
| 150 mm – 6" | tk 8288-15 | tk 8289-15 |
| 170 mm – 6¾" | tk 8288-17 | tk 8289-17 |

Chirurgische Scheren – Präparierscheren
Operating scissors – Dissecting scissors

Ciseaux à chirurgie – Ciseaux à dissection
Tijeras para cirugía – Tijeras de disección
 Forbici per chirurgia – Forbici per dissezione

TUCARTK

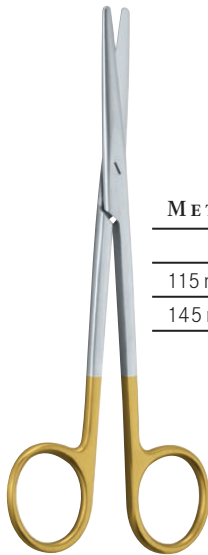

| METZENBAUM | Fig. 1 | Fig. 2 | Fig. 3 |
|--------------|-------------------|-------------------|-------------------|
| 115 mm – 4½" | tk 8327-11 | | |
| 145 mm – 5¾" | tk 8327-14 | tk 8328-14 | tk 8329-14 |

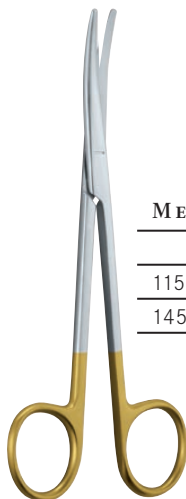

| METZENBAUM | Fig. 1 | Fig. 2 | Fig. 3 |
|--------------|-------------------|-------------------|-------------------|
| 115 mm – 4½" | tk 8337-11 | | |
| 145 mm – 5¾" | tk 8337-14 | tk 8338-14 | tk 8339-14 |

Chirurgische Scheren – Präparierscheren
Operating scissors – Dissecting scissors

Ciseaux à chirurgie – Ciseaux à dissection
Tijeras para cirugía – Tijeras de disección
 Forbici per chirurgia – Forbici per dissezione

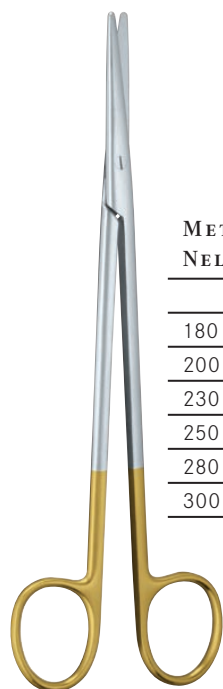

METZENBAUM-
NELSON



| | Fig. 1 | Fig. 2 | Fig. 3 |
|--------------|-------------------|-------------------|-------------------|
| 180 mm – 7" | tk 8347-18 | tk 8348-18 | tk 8349-18 |
| 200 mm – 8" | tk 8347-20 | tk 8348-20 | tk 8349-20 |
| 230 mm – 9" | tk 8347-23 | tk 8348-23 | tk 8349-23 |
| 250 mm – 10" | tk 8347-25 | | |
| 280 mm – 11" | tk 8347-28 | | |
| 300 mm – 12" | tk 8347-30 | | |

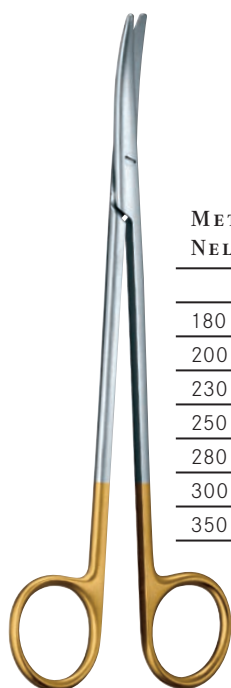

METZENBAUM-
NELSON



| | Fig. 1 | Fig. 2 | Fig. 3 |
|--------------|-------------------|-------------------|-------------------|
| 180 mm – 7" | tk 8357-18 | tk 8358-18 | tk 8359-18 |
| 200 mm – 8" | tk 8357-20 | tk 8358-20 | tk 8359-20 |
| 230 mm – 9" | tk 8357-23 | tk 8358-23 | tk 8359-23 |
| 250 mm – 10" | tk 8357-25 | | |
| 280 mm – 11" | tk 8357-28 | | |
| 300 mm – 12" | tk 8357-30 | | |
| 350 mm – 14" | tk 8357-35 | | |

Chirurgische Scheren – Präparierscheren
Operating scissors – Dissecting scissors

Ciseaux à chirurgie – Ciseaux à dissection
Tijeras para cirugía – Tijeras de disección
Forbici per chirurgia – Forbici per dissezione

TUCARTK



**METZENBAUM-
FINO**



| | | |
|--------------|-------------------|-------------------|
| | Fig. 1 | Fig. 1 |
| 145 mm – 5¾" | tk 8363-14 | tk 8365-14 |



**METZENBAUM-
FINO**



| | | |
|--------------|-------------------|-------------------|
| | Fig. 3 | Fig. 3 |
| 145 mm – 5¾" | tk 8366-14 | tk 8367-14 |

Präparierscheren
Dissecting scissors

Ciseaux à dissection
Tijeras de disección
Forbici per dissezione

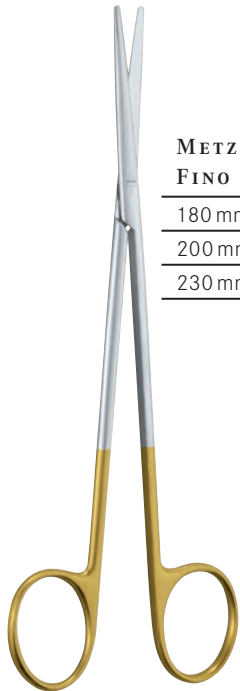

METZENBAUM-FINO

| | | |
|-------------|------------|------------|
| 180 mm – 7" | tk 8370-18 | tk 8371-18 |
| 200 mm – 8" | tk 8370-20 | tk 8371-20 |
| 230 mm – 9" | tk 8370-23 | tk 8371-23 |

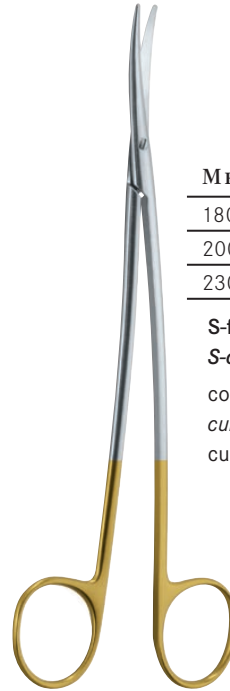

METZENBAUM-FINO

| | |
|-------------|------------|
| 180 mm – 7" | tk 9725-18 |
| 200 mm – 8" | tk 9725-20 |
| 230 mm – 9" | tk 9725-23 |

S-förmig gebogen
S-curved

courbes en S
curva en S
curve a forma di S

Feine Scheren
Fine scissors

Ciseaux fins
Tijeras finas
Forbici fini



LOCKLIN

| | | |
|--------------|------------|------------|
| 165 mm – 6½" | tk 8591-16 | tk 8589-16 |
|--------------|------------|------------|

gerade, gezahnt
straight, saw edge
droits, dentelés
recta, dentada
rette, dentate

gebogen, gezahnt
curved, saw edge
courbes, dentelés
curva, dentada
curve, dentate

Scheren für die Plastische Chirurgie
Plastic surgery scissors

Ciseaux pour la chirurgie plastique
Tijeras para la cirugía plástica
Forbici per chirurgia plastica

TUCARTK



GORNEY

200 mm – 8"

tk 8702-20

tk 8703-20

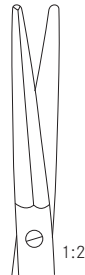

KAYE

115 mm – 4½"

tk 8696-11



Bitte fordern Sie unseren Spezialkatalog für Plastische Chirurgie an.
Please ask for our special catalogue for plastic surgery.

Veillez demander pour notre catalogue spécial pour la chirurgie plastique.
Por favor preguntan para el catalogo especial para la cirugía plástica.

Per favore domandate per il nostro catalogo speciale per la chirurgia plastica.

Gefäßscheren
Artery scissors

Ciseaux vasculaires
Tijeras vasculares
Forbici vascolari



| DE BAKEY | 25° | 45° | 60° |
|--------------|------------|------------|------------|
| 160 mm – 6¼" | tk 8775-16 | tk 8776-16 | tk 8777-16 |
| 230 mm – 9" | tk 8775-23 | tk 8776-23 | tk 8777-23 |
| 280 mm – 11" | tk 8775-28 | tk 8776-28 | tk 8777-28 |

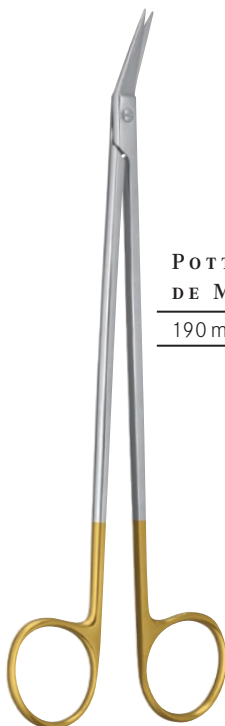

| POTTS- DE MARTEL | 25° | 45° | 60° |
|---------------------|------------|------------|------------|
| 190 mm – 7½" | tk 8773-25 | tk 8773-45 | tk 8773-60 |

Tonsillenscheren
Tonsil scissors

Ciseaux pour les amygdales
Tijera para amigdales
Forbici per tonsille

TUCARTK



TOENNIS-
ADSON

170 mm – 6 $\frac{3}{4}$ "

tk9718-17

1:2



DEAN

170 mm – 6 $\frac{3}{4}$ "

tk8859-17

gebogen, gezahnt
curved, saw edge

curvas, dentelés
curvas, dentadas

curve, dentate

1:2

Parametriumscheren
Parametrium scissors

Parametrium ciseaux
Parametrium tijera
Forbici per il parametrio

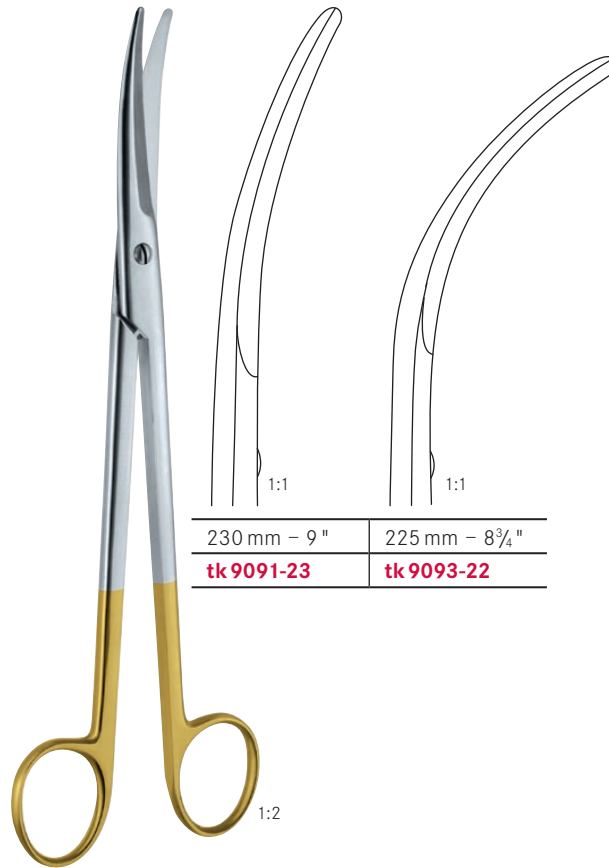

Irisscheren
Iris scissors

Ciseaux à iridectomie
Tijeras para iridectomia
Forbici per iridectomia

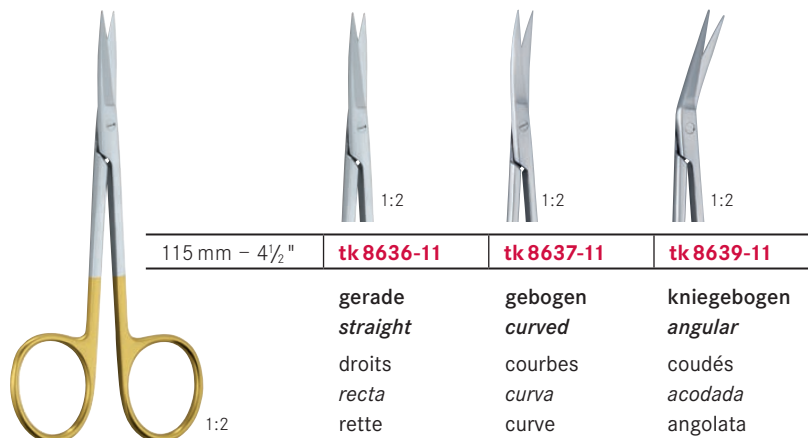

Drahtschere
Wire cutting scissors

Cisaille pour fils
Cizalla para cortar alambre
Forbice per filo metallico

TUCARTK



UNIVERSAL

120 mm – 4³/₄ "

tk 9629-12

Verbandscheren
Bandage scissors

Ciseaux pour pansements
Tijeras para vendajes
Forbici per bendaggi



LISTER

180 mm – 7 "

tk 9677-18

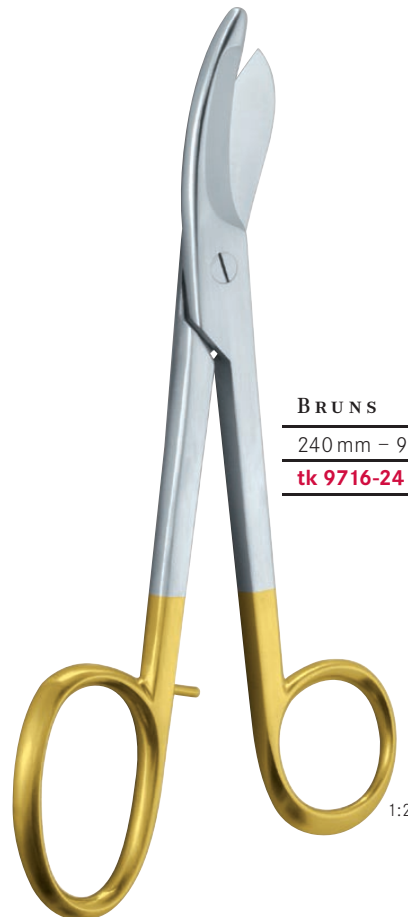

BRUNS

240 mm – 9¹/₂ "

tk 9716-24

SUPERCUT^{TK}

SuperCut Scheren (SU) SuperCut scissors (SU)

Ciseaux SuperCut (SU)
SuperCut tijeras (SU)
Forbici con taglio SuperCut (SU)



Ein äußerst scharfer Osteotomschliff am oberen Scherenblatt gewährt das leichte Abscheren des Gewebes. Das zweite Scherenblatt ist leicht gezahnt, um das Abrutschen des Gewebes zu vermeiden. SuperCut-Scheren sind an einem goldenen Ring zu erkennen. Auf Wunsch kann jedes andere Modell in SuperCut geliefert werden. Auf Wunsch können SuperCut Scheren auch ohne Zahnung geliefert werden.

An extremely sharp osteotome cut on the upper blade guarantees easy and precise cutting of the tissue. The other blade is slightly serrated for fixing the tissue. SuperCut scissors are indicated by one golden ring. Any other tekno scissors can be supplied as tekno SuperCut upon request. SuperCut scissors can be supplied upon request without serration.

L'aiguisage extrêmement coupante «osteotome» de la lame supérieure, garantit une coupure facile et précise du tissu. La deuxième lame est légèrement dentelée pour tenir le tissu. Ciseaux SuperCut peuvent être identifiées à une bague d'orée. Tous les autres ciseaux peuvent être fournis en version SuperCut sur demande. Les ciseaux SuperCut peuvent être fournis également non dentelés sur demande.

A través de un filo de "osteotomo" extremo agudo de una hoja es posible cortar facilmente precisamente el tejido. La segunda hoja tiene dientes muy suaves para evitar que se desliza el tejido. Las tijeras SuperCut se reconocen de un anillo dorado. Todas las otras tijeras pueden ser producidos en SuperCut segun demanda. Las tijeras SuperCut pueden ser producidos también sin dientes segun demanda.

La affilatura speciale della lama superiore a forma di osteotomo da' un taglio estremamente facile e preciso. Una leggera dentatura sulla seconda lama evita che il tessuto scivoli. Per distinguersi dalle altre forbici, le forbici SuperCut hanno un anello dorato. Se richiesto le forbici SuperCut si forniscono pure senza la zigrinatura su una lama. Se richiesto ogni altro modello di forbici può essere fornito con taglio SuperCut.

Chirurgische Scheren
Operating scissors

Ciseaux à chirurgie
Tijeras para cirugía
Forbici per chirurgia

SUPERCUT



Chirurgische Scheren
Operating scissors

Ciseaux à chirurgie
Tijeras para cirugía
Forbici per chirurgia

SUPERCUT^{TK}

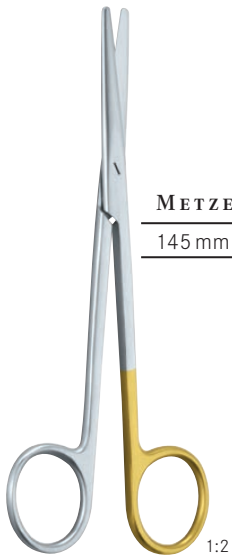

METZENBAUM

| | | |
|--------------|----------------------|----------------------|
| | 1:2 | 1:2 |
| 145 mm – 5¾" | tk 8323-14 SU | tk 8333-14 SU |

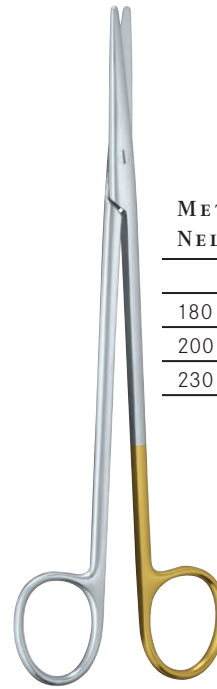

METZENBAUM-NELSON

| | | |
|-------------|----------------------|----------------------|
| | Fig. 1 | Fig. 1 |
| 180 mm – 7" | tk 8343-18 SU | tk 8353-18 SU |
| 200 mm – 8" | tk 8343-20 SU | tk 8353-20 SU |
| 230 mm – 9" | tk 8343-23 SU | tk 8353-23 SU |

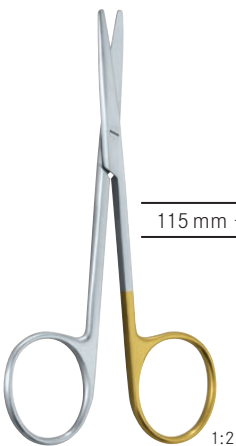

METZENBAUM

| | | |
|--------------|----------------------|----------------------|
| | 1:2 | 1:2 |
| 115 mm – 4½" | tk 9482-11 SU | tk 9483-11 SU |

Chirurgische Scheren
Operating scissors

Ciseaux à chirurgie
Tijeras para cirugía
Forbici per chirurgia

SUPERCUT

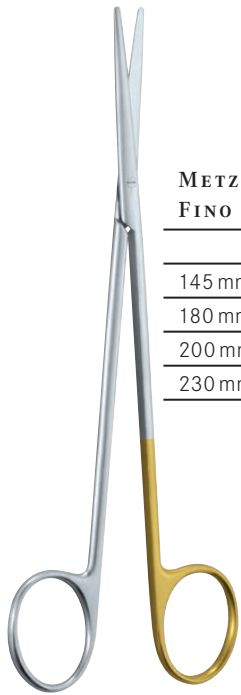

METZENBAUM-FINO

| | Fig. 1 | Fig. 2 |
|--------------|----------------------|----------------------|
| 145 mm – 5¾" | tk 8372-14 SU | tk 8373-14 SU |
| 180 mm – 7" | tk 8380-18 SU | tk 8381-18 SU |
| 200 mm – 8" | tk 8380-20 SU | tk 8381-20 SU |
| 230 mm – 9" | tk 8380-23 SU | tk 8381-23 SU |

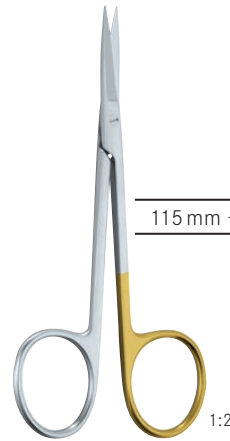

115 mm – 4½"

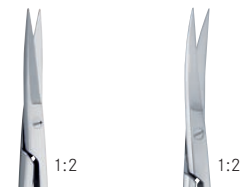

tk 9432-11 SU

tk 9434-11 SU



GOLDMANN-Fox

| | | |
|-------------|----------------------|----------------------|
| 130 mm – 5" | tk 9922-13 SU | tk 9923-13 SU |
|-------------|----------------------|----------------------|

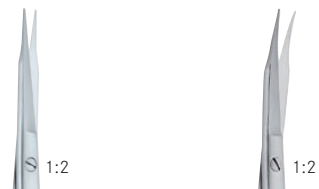

1:2

1:2

Chirurgische Scheren
Operating scissors

Ciseaux à chirurgie
Tijeras para cirugía
Forbici per chirurgia

SUPERCUT^{TK}



JOSEPH

140 mm – 5½"



1:2

tk 8692-14 SU



1:2

tk 8693-14 SU

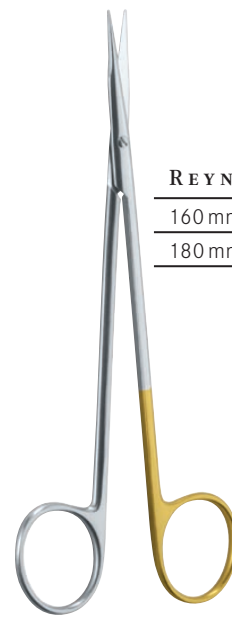

REYNOLDS

160 mm – 6¼"



tk 8602-16 SU



tk 8603-16 SU

180 mm – 7"

tk 8602-18 SU

tk 8603-18 SU



FOMON

130 mm – 5"

tk 9152-13 SU



STEVENS

100 mm – 4"



tk 9462-10 SU



tk 9463-10 SU

110 mm – 4¼"

tk 9462-11 SU

tk 9463-11 SU

