



Scissors – Rib Shears – Wire Saws – Bone Biting Rongeurs



Toennis-Adson TC

Extra delicate scissors with slightly curved edges, ideally suited for I.M.A.-dissection

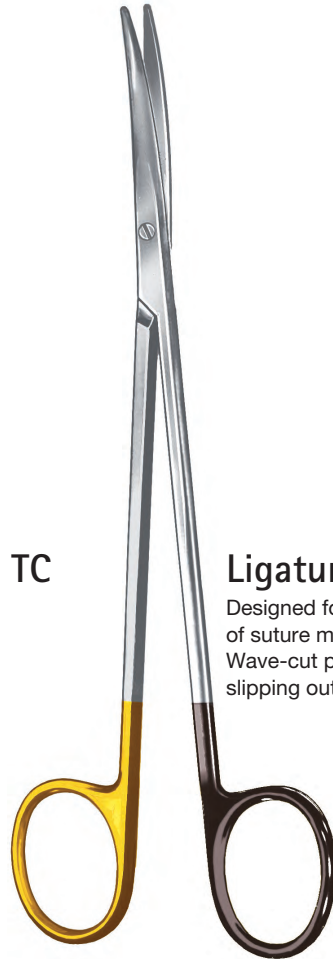

Ligature TC

Designed for cutting of suture materials. Wave-cut prevents slipping out.



Metzenbaum TC

S-curved SH/BL

Toennis-Adson TC

fino

26-0118 17.5 cm

26-0118.23 23.0 cm

superfino

26-0116 17.5 cm

Ligature TC

y-shanks

26-0498 14.0 cm

26-0500 18.0 cm

26-0501 23.0 cm

26-0502 25.0 cm

Ligature TC

straight shanks

26-0500G 17.5 cm

26-0501G 23.0 cm

26-0502G 25.0 cm

Metzenbaum TC

26-0119 14.5 cm/5½"

The logo for GEISTER, featuring the word "GEISTER" in a bold, red, serif font. The letters "G" and "E" are partially enclosed by a light blue, semi-transparent oval shape.

Metzenbaum TC

curved

26-0103

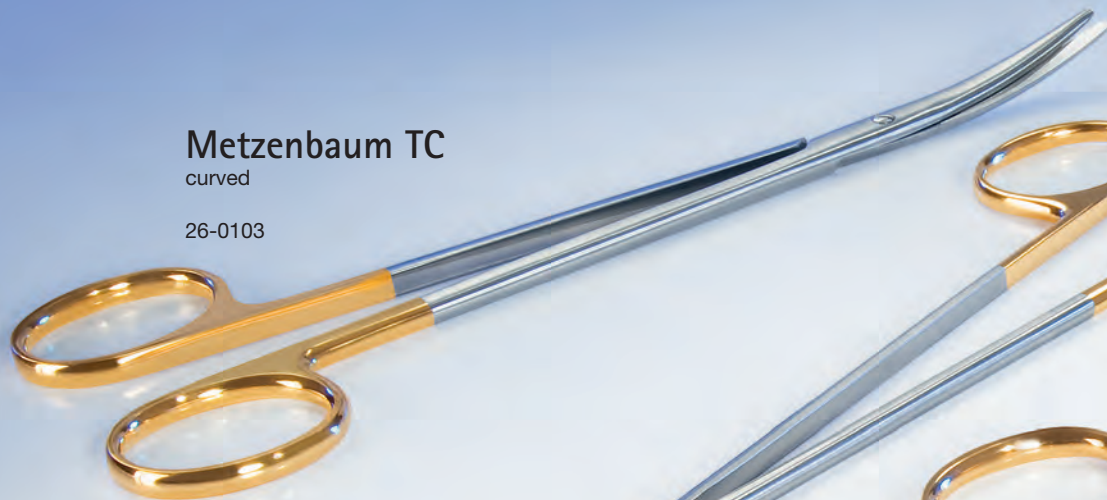

Metzenbaum Fino TC

straight

26-0122





Metzenbaum TC

straight

26-0102



Metzenbaum Fino TC

curved

26-0123



Metzenbaum TC

straight

26-0100	26-0102	26-0104	26-0106	26-0108	26-0110	26-0112
14 cm	18 cm	20 cm	23 cm	25 cm	28 cm	30 cm

Nelson Metzenbaum TC

straight

26-0100	26-0102	26-0104	26-0106	26-0108	26-0110	26-0112
14 cm	18 cm	20 cm	23 cm	25 cm	28 cm	30 cm

Metzenbaum TC

curved

26-0101	26-0103	26-0105	26-0107	26-0109	26-0111	26-0113	26-0115
14 cm	18 cm	20 cm	23 cm	25 cm	28 cm	30 cm	36 cm

Nelson Metzenbaum TC

curved

26-0101	26-0103	26-0105	26-0107	26-0109	26-0111	26-0113	26-0115
14 cm	18 cm	20 cm	23 cm	25 cm	28 cm	30 cm	36 cm

Metzenbaum Fino TC (delicate)

straight

26-0120	26-0122	26-0124	26-0126
14 cm	18 cm	20 cm	23 cm

curved

26-0121	26-0123	26-0125	26-0127	26-0129	26-0131
14 cm	18 cm	20 cm	23 cm	26 cm	28 cm

**Metzenbaum-Fino TC pointed****straight**

26-0180	26-0182	26-0184	26-0186
14 cm	18 cm	20 cm	23 cm

curved

26-0181	26-0183	26-0185	26-0187
14 cm	18 cm	20 cm	23 cm

Standard TC**straight**

blunt/blunt	sharp/blunt	sharp/sharp
26-0010	26-0011	26-0012
14.5 cm	14.5 cm	14.5 cm

curved

blunt/blunt	sharp/blunt	sharp/sharp
26-0013	26-0014	26-0015
14.5 cm	14.5 cm	14.5 cm

Metzenbaum-Fino TC

pointed

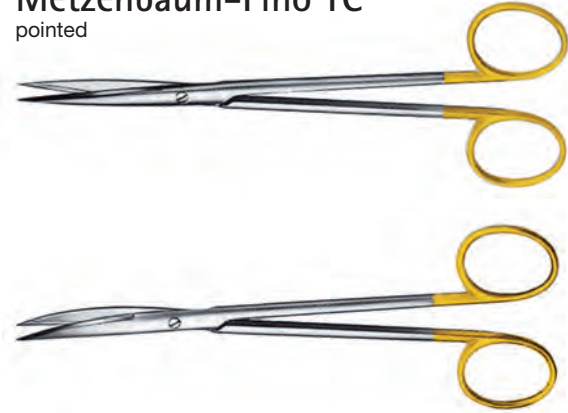
**Standard TC**

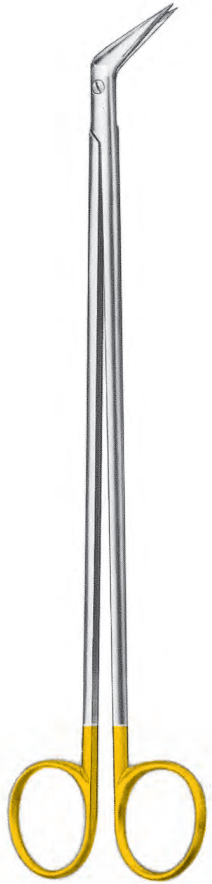

DeBakey TC

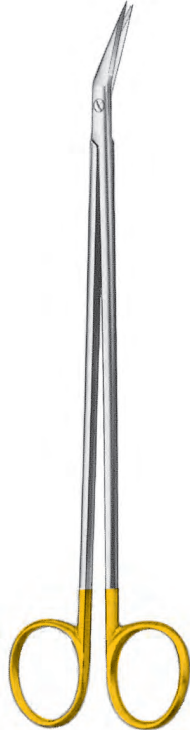

Potts-Smith TC



Mayo-Stille TC

**DeBakey TC**

25°	45°	65°
26-0210	26-0215	26-0220
17 cm/6½"	17 cm/6½"	17 cm/6½"
26-0211	26-0216	26-0221
23 cm/9"	23 cm/9"	23 cm/9"
26-0212	26-0217	26-0222
28 cm/11"	28 cm/11"	28 cm/11"

Potts-Smith TC

25°	45°	65°
26-0200	26-0201	26-0202
19 cm/7½"	19 cm/7½"	19 cm/7½"

Mayo-Stille TC

straight	
26-0030	26-0032
15 cm/6"	17 cm/6½"
curved	
26-0031	26-0033
15 cm/6"	17 cm/6½"



**Mayo TC
straight**

26-0020	26-0022	26-0025
14 cm	17 cm	23 cm

curved

26-0021	26-0023	26-0026
14 cm	17 cm	23 cm

**Mayo-Lexer TC
straight**

26-0040	26-0042
16 cm	21 cm

curved

26-0041	26-0043
16 cm	21 cm



Mayo TC



Mayo-Lexer TC

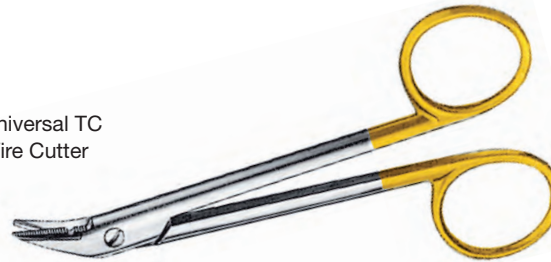

Iris TC

Universal TC
Wire Cutter

Strabismus TC



Goldmann-Fox TC



Iris TC
straight **curved**
 26-0150 26-0151
 11 cm 11 cm

Strabismus TC
straight **curved**
 26-0155 26-0156
 11 cm 11 cm

Universal TC Wire Cutter
 26-0140
 12 cm

Goldmann-Fox TC
straight **curved**
 26-0160 26-0161
 13 cm 13 cm



Metzenbaum Fino "ST"

26-6217.ST

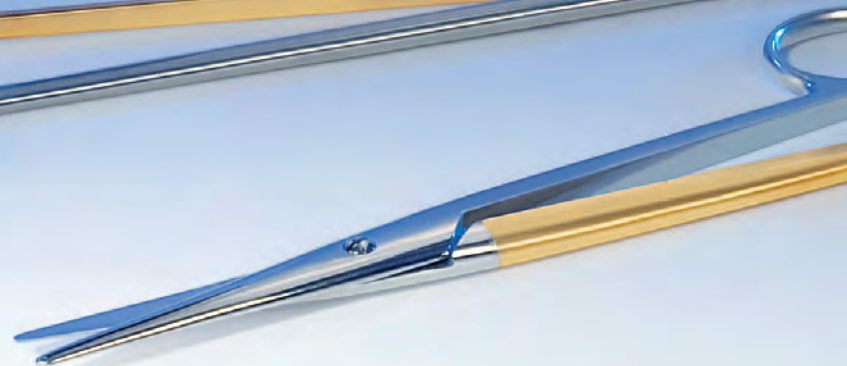

26-6201.ST

Metzenbaum "ST"





Experience the ultimate cutting performance!

- top class product with special construction
- ultra-sharp edges for ultimate cutting performance
- smooth cutting action
- for fine as well as coarse tissue
- special hardened for maximum durability and long lasting sharpness
- one shank gold plated for identification
- aseptic surface finish



Mayo-Style "ST"

26-6132.ST

Toennis-Adson-Superfino "ST"

curved

26-6148.ST

17.5 cm/6½"

Mayo-Style "ST"

straight

26-6132.ST

17 cm/6½"

26-6134.ST

19 cm/7½"

curved

26-6133.ST

17 cm/6½"

26-6135.ST

19 cm/7½"

Metzenbaum "ST"

straight

26-6190.ST

14 cm/5½"

26-6191.ST

18 cm/7"

26-6192.ST

20 cm/8"

26-6193.ST

23 cm/9"

26-6194.ST

25 cm/10"

curved

26-6200.ST

14 cm/5½"

26-6201.ST

18 cm/7"

26-6202.ST

20 cm/8"

26-6203.ST

23 cm/9"

26-6204.ST

25 cm/10"

26-6148.ST

Toennis-Adson-Superfino "ST"

Metzenbaum Fino "ST"

straight

26-6208.ST

14 cm/5½"

26-6210.ST

18 cm/7"

26-6211.ST

20 cm/8"

26-6212.ST

23 cm/9"

26-6213.ST

25 cm/10"

curved

26-6209.ST

14 cm/5½"

26-6215.ST

18 cm/7"

26-6216.ST

20 cm/8"

26-6217.ST

23 cm/9"

26-6218.ST

25 cm/10"



Reynolds "ST"
(Metzenbaum Tenotomy)

26-6252.ST

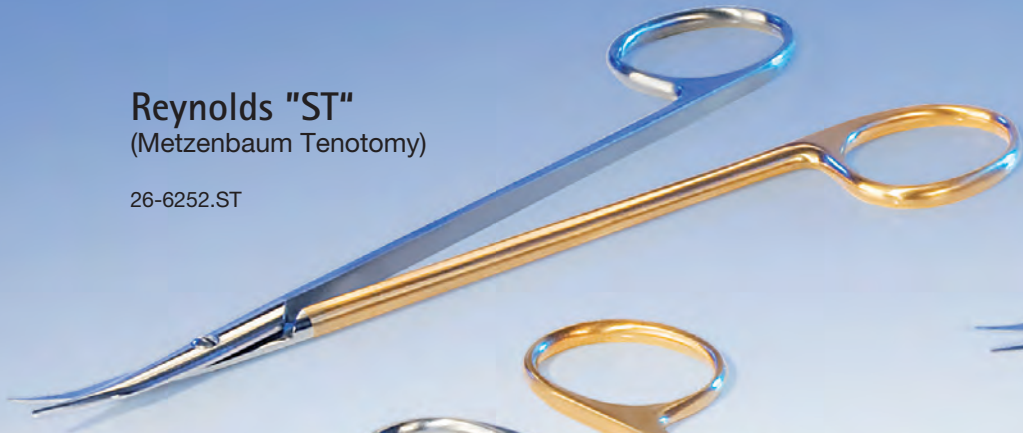

Iris "ST"

26-6691.ST



26-6161.ST

Stevens "ST"



Swedish Edge™
= "ST"

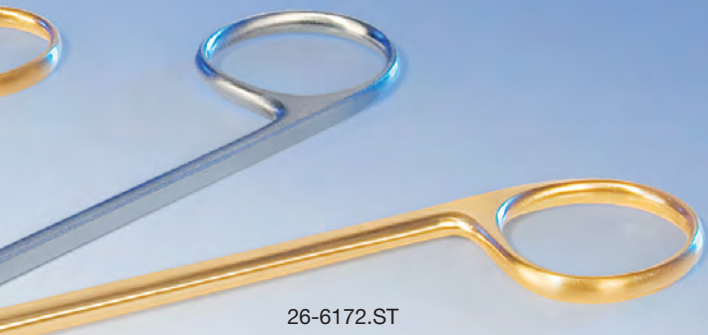

26-6172.ST

Ragnell-Kilner "ST"

Experience the ultimate cutting performance!

- top class product with special construction
- ultra-sharp edges for ultimate cutting performance
- smooth cutting action
- for fine as well as coarse tissue
- special hardened for maximum durability and long lasting sharpness
- one shank gold plated for identification
- aseptic surface finish

Stevens "ST"

straight	curved
26-6160.ST	26-6161.ST
12.5 cm/4½"	12.5 cm/4½"

Iris "ST"

straight		curved	
26-6686.ST	26-6690.ST	26-6687.ST	26-6691.ST
10.5 cm/4"	12.5 cm/4½"	10.5 cm/4"	12.5 cm/4½"

Reynolds "ST"

(Metzenbaum Tenotomy)

straight				
26-6240.ST	26-6242.ST	26-6244.ST	26-6246.ST	26-6248.ST
13 cm/5"	15 cm/6"	18 cm/7"	20 cm/8"	23 cm/9"
curved				
26-6250.ST	26-6252.ST	26-6254.ST	26-6256.ST	26-6258.ST
13 cm/5"	15 cm/6"	18 cm/7"	20 cm/8"	23 cm/9"

Ragnell-Kilner "ST"

curved			
26-6170.ST	26-6172.ST	26-6174.ST	26-6176.ST
12.5 cm/4½"	15 cm/6"	18 cm/7"	20 cm/8"



Metzenbaum

curved

26-6201



Metzenbaum

straight

26-6190



26-6217.SC



Metzenbaum Fino "SC"

curved

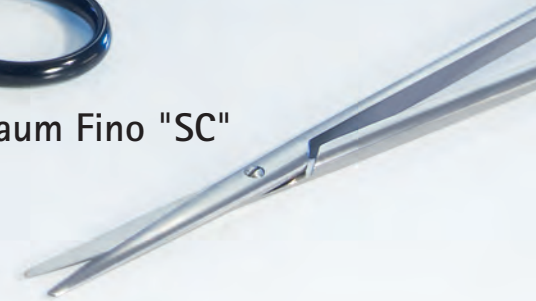

26-6201.SC

Metzenbaum "SC"

curved





Metzenbaum Fino

curved

26-6215

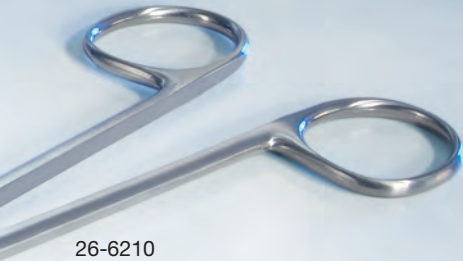

26-6210

Metzenbaum Fino

straight

■ SC = Super Cut

Metzenbaum straight

26-6190	26-6191	26-6192	26-6193	26-6194	26-6195	26-6196
14 cm	18 cm	20 cm	23 cm	25 cm	28 cm	31 cm
26-6190.SC	26-6191.SC	26-6192.SC	26-6193.SC	26-6194.SC	26-6195.SC	26-6196.SC

curved

26-6200	26-6201	26-6202	26-6203	26-6204	26-6205	26-6206
14 cm	18 cm	20 cm	23 cm	25 cm	28 cm	31 cm
26-6200.SC	26-6201.SC	26-6202.SC	26-6203.SC	26-6204.SC	26-6205.SC	26-6206.SC

Metzenbaum Fino (delicate)

straight

26-6208	26-6210	26-6211	26-6212	26-6213	26-6214
14 cm	18 cm	20 cm	23 cm	25 cm	28 cm
26-6208.SC	26-6210.SC	26-6211.SC	26-6212.SC	26-6213.SC	26-6214.SC

curved

26-6209	26-6215	26-6216	26-6217	26-6218	26-6219
14 cm	18 cm	20 cm	23 cm	25 cm	28 cm
26-6209.SC	26-6215.SC	26-6216.SC	26-6217.SC	26-6218.SC	26-6219.SC

Metzenbaum Fino (pointed tip)

straight

26-6230	26-6231	26-6232	26-6235	26-6236	26-6237
18 cm/7"	20 cm/8"	23 cm/9"	18 cm/7"	20 cm/8"	23 cm/9"
26-6230.SC	26-6231.SC	26-6232.SC	26-6235.SC	26-6236.SC	26-6237.SC

curved

Metzenbaum Fino

S-curved

26-6225	26-6226	26-6227	26-6228	26-6229
18 cm/7"	20 cm/8"	23 cm/9"	25 cm/10"	28 cm/11"
26-6225.SC	26-6226.SC	26-6227.SC	26-6228.SC	26-6229.SC



Hohenfellner



Hohenfellner

Art.-No.	Fig.	Length
26-2510	A	18 cm/7"
26-2515	B	21 cm/8¼"
26-2520	C	24 cm/9½"

DeBakey

Art.-No.	Fig.	Length
26-2530	A	20 cm/8"
26-2535	B	17.5 cm/6½"

DeBakey

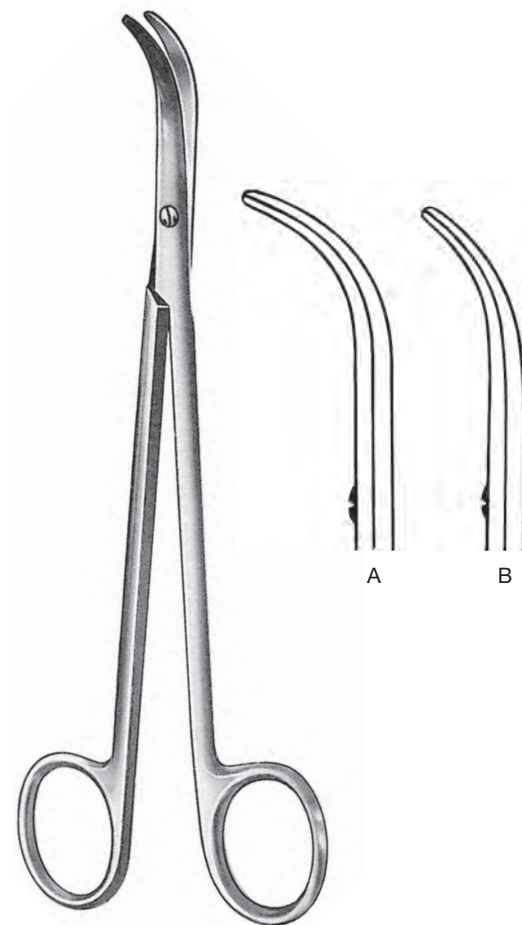

Thorek

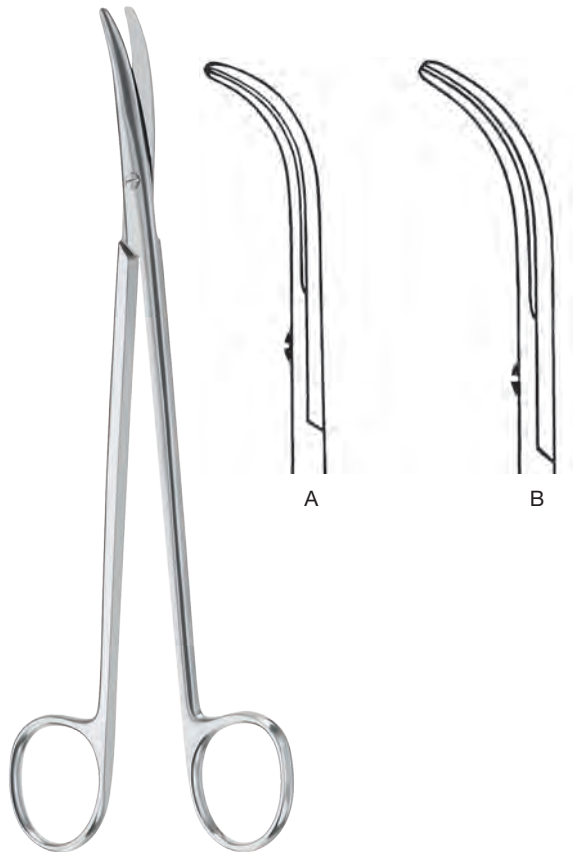

Satinsky

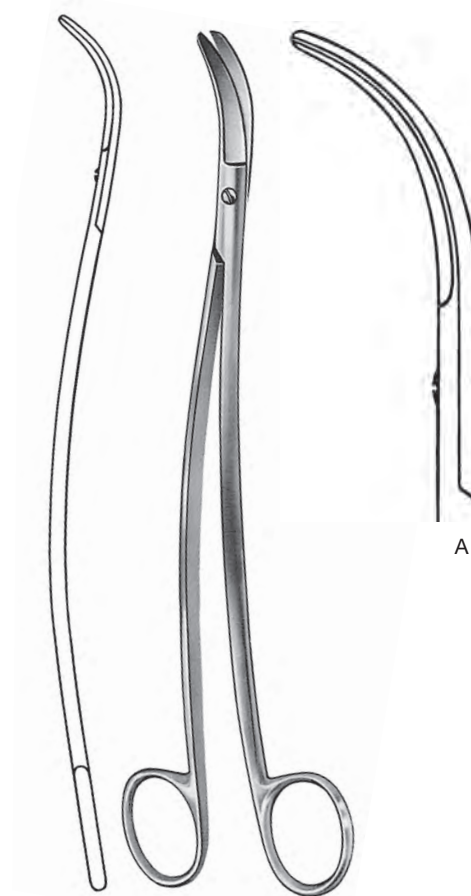

Thorek		
Art.-No.	Fig.	Length
26-2540	A	19 cm/7½"
26-2542	B	25 cm/10"
Satinsky		
Art.-No.	Fig.	Length
26-2525	A	24.5 cm/9½"

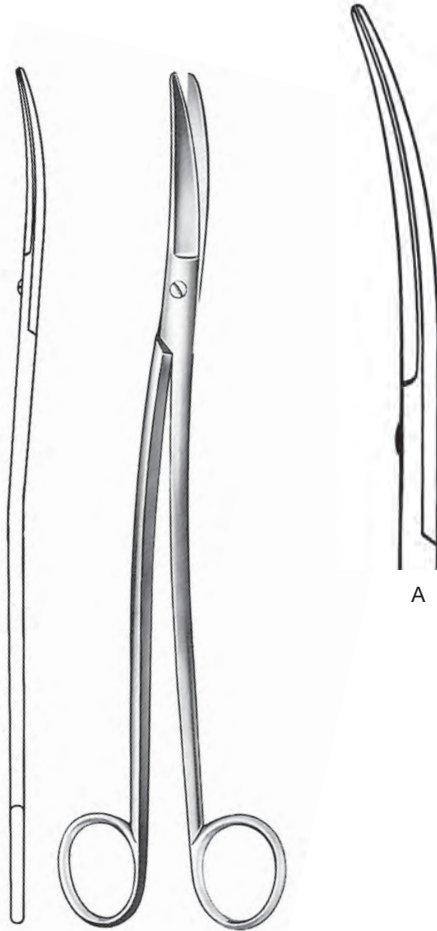

Klingenberg-Loth

**Klingenberg-Loth**

Art.-No.	Fig.	Length
26-2527	A	23 cm/9"

Wertheim

Art.-No.	Fig.	Length
26-2550	A	14.5 cm/5½"
26-2552	B	19.5 cm/7½"
26-2554	C	22.5 cm/8½"

Wertheim

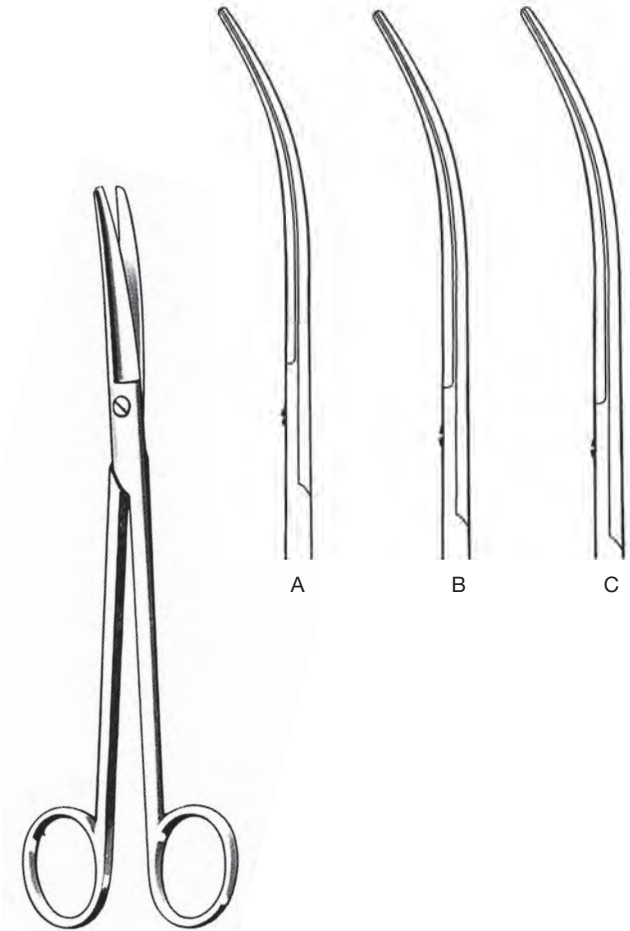



Beall

Swan Neck Scissors

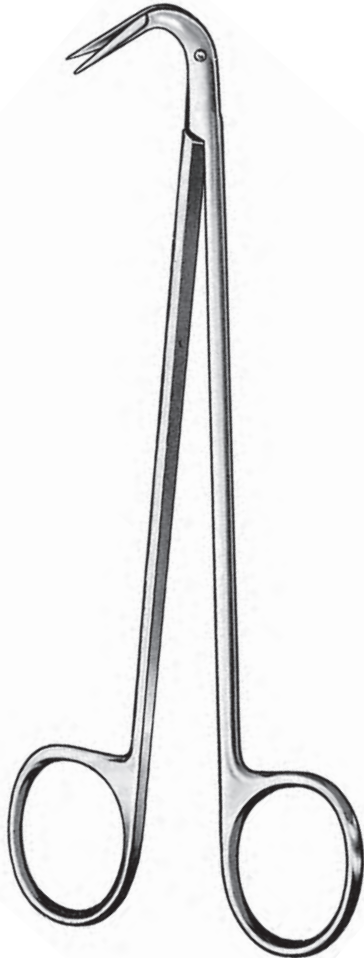

Diethrich-Hegemann

Coronary Scissors with extra delicate micro tips

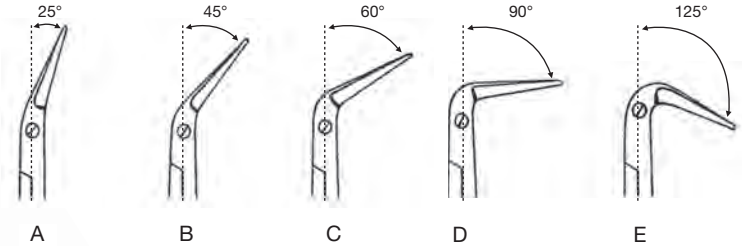
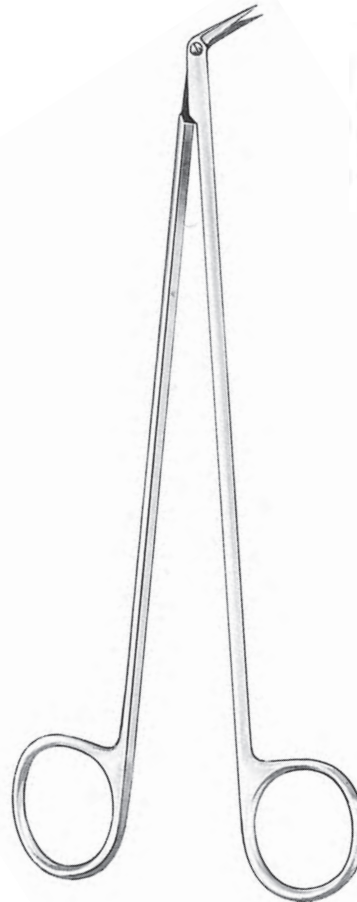

■ SC = Super Cut

Beall				
Swan Neck Scissors				
Art.-No.			Length	
26-4090	sharp		14.5 cm/5½"	
Diethrich-Hegemann				
Coronary Scissors				
with extra delicate micro tips				
Fig.	Length	✂	Art.-No. regular	Art.-No. nano blades
A	180 cm/7"	25°	26-4100 26-4100.SC	26-4300 26-4300.SC
B	180 cm/7"	45°	26-4102 26-4102.SC	26-4302 26-4302.SC
C	180 cm/7"	60°	26-4104 26-4104.SC	26-4304 26-4304.SC
D	180 cm/7"	90°	26-4106 26-4106.SC	26-4306 26-4306.SC
E	180 cm/7"	125°	26-4108 26-4108.SC	26-4308 26-4308.SC
with bar				
E	180 cm/7"	125°	26-4110	26-4110.SC

Favaloro

Coronary Scissors

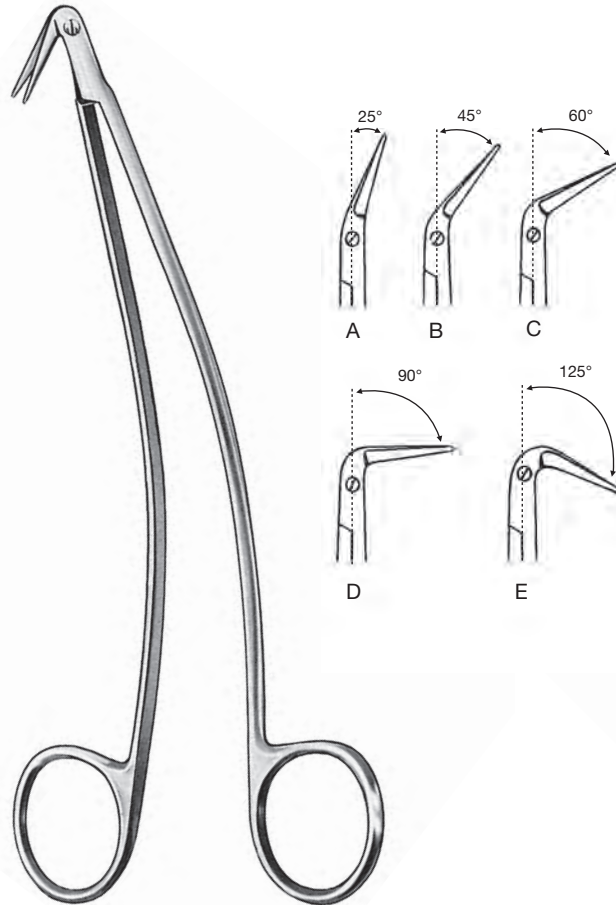

Favaloro Coronary Scissors

Art.-No.	Fig.		Length
26-4101	A	25°	180 cm/7''
26-4103	B	45°	180 cm/7''
26-4105	C	60°	180 cm/7''
26-4107	D	90°	180 cm/7''
26-4109	E	125°	180 cm/7''

De Martel Vascular and Valve Scissors

Art.-No.	Fig.		Length
sharp			
26-4020	A	50°	180 cm/7''
26-4025	B	90°	170 cm/6½''
blunt			
26-4021	A	50°	180 cm/7''
26-4026	B	90°	170 cm/6½''

De Martel

Vascular Scissors

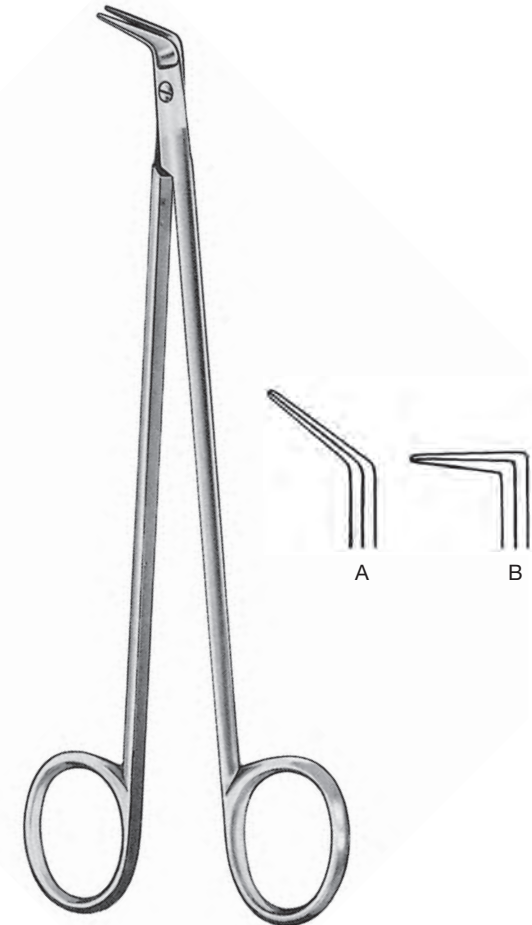

Favaloro

DeBakey "S"

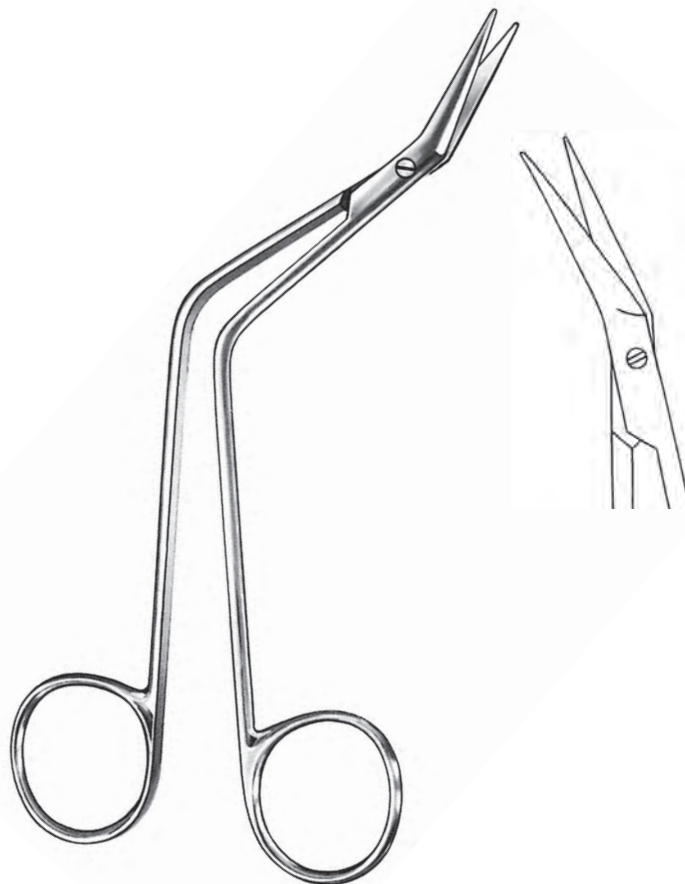

Favaloro		
Art.-No.	✂	Length
26-4135	60°	17 cm/6½"
DeBakey "S"		
Art.-No.	✂	Length
26-4132	45°	16 cm/6¼"



Lillehei-Potts

Laine-Kindal

**Lillehei-Potts**

Art.-No.	Fig.	Length
26-4060	A	18 cm/7"
26-4062	B	18 cm/7"

Laine-Kindal

Art.-No.	Fig.	Length
26-4074	A	18 cm/7"
26-4075	A	21 cm/8¼"
26-4076	B	18 cm/7"
26-4077	B	21 cm/8¼"



In-Situ

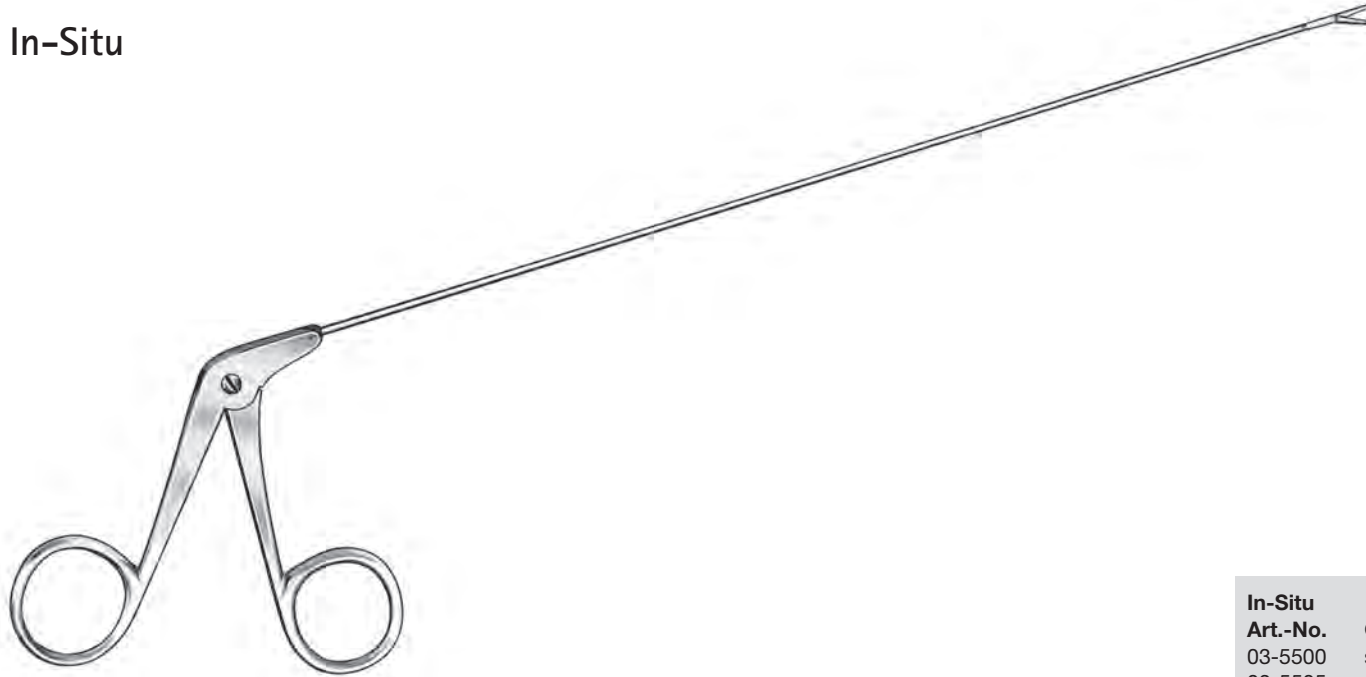

Valvulotome

with ball tip



In-Situ

Art.-No.	Curvature	Length
03-5500	straight	10 cm/4''
03-5505	straight	23 cm/9''
03-5509	straight	30 cm/12''
03-5510	for left thigh	30 cm/12''
03-5515	for right thigh	30 cm/12''

Valvulotome with ball tip Retrograde

Art.-No.	Length
03-7500	30.5 cm/12''
03-7505	25 cm/10''
03-7510	23 cm/9''

Antegrade

Art.-No.	Length
03-7520	16 cm/6½''



Vascular Scissors

Gregory
Arteriotomy Scissors



Gregory
Vertebral Scissors

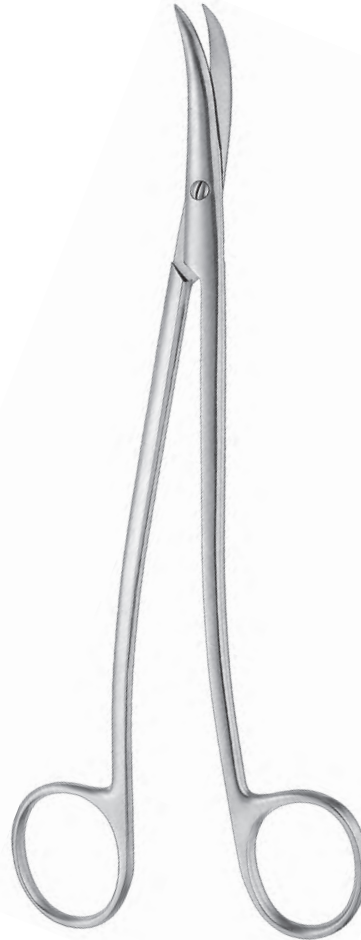

Gregory
Dissecting Scissors



Gregory
Arteriotomy Scissors
Art.-No. ✂ Length
26-4149 45° 13 cm/5''

Gregory
Vertebral Scissors
Art.-No. Length
26-4150 16 cm/6¼''

Gregory
Dissecting Scissors
Art.-No. Length
26-4148 14.5 cm/5¾''

DeBakey

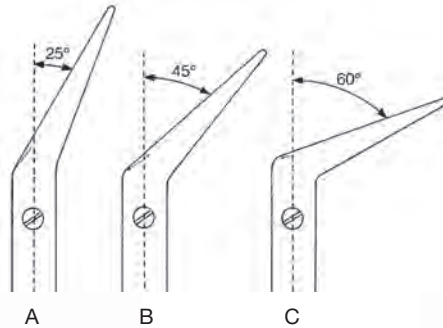
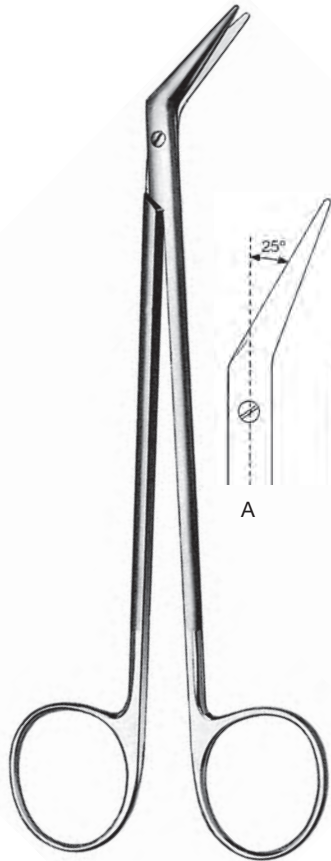

Potts-Smith

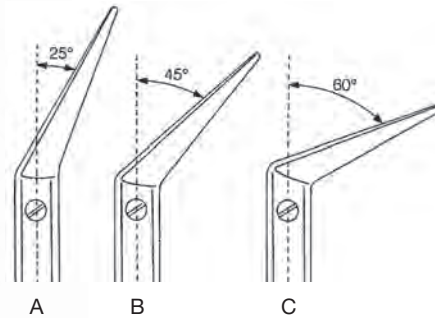
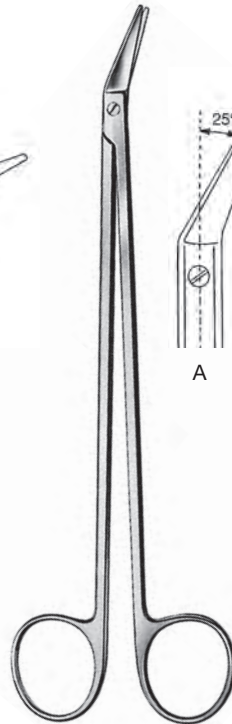
**DeBakey**

Art.-No.	Fig.	✂	Length
26-4175	A	25°	17 cm/6½"
26-4180	A	25°	23 cm/9"
26-4185	A	25°	28 cm/11"
26-4176	B	45°	17 cm/6½"
26-4182	B	45°	23 cm/9"
26-4186	B	45°	28 cm/11"
26-4177	C	60°	17 cm/6½"
26-4184	C	60°	23 cm/9"
26-4187	C	60°	28 cm/11"

Potts-Smith

Art.-No.	Fig.	✂	Length
26-4160	A	25°	14 cm/5½"
26-4120	A	25°	19 cm/7½"
26-4122	B	45°	19 cm/7½"
26-4124	C	60°	19 cm/7½"
with ball			
26-4126	C	60°	19 cm/7½"

GEISTER®

Potts



■ SC = Super Cut

Potts

26-4082
18.5 cm/7"

Kelly

straight

26-6720
16 cm/6¼"
26-6720.SC

26-6725
18 cm/7"
26-6725.SC

curved

26-6721
16 cm/6¼"
26-6721.SC

26-6726
18 cm/7"
26-6726.SC

Joseph

straight

26-6700
15 cm/6"
26-6700.SC

curved

26-6701
15 cm/6"
26-6701.SC

Iris

straight

26-6690
12.5 cm/4½"
26-6688
11.5 cm/4¼"
26-6688.SC

curved

26-6691
12.5 cm/4½"
26-6689
11.5 cm/4¼"
26-6689.SC

angular

26-6692
12.5 cm/4½"

26-6686
10.5 cm/4"
26-6684
9.5 cm/3½"

26-6687
10.5 cm/4"
26-6685
9.5 cm/3½"

Kelly

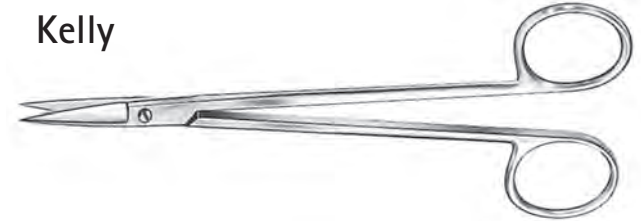

Joseph



Iris





Lexer-Baby



Stevens

■ SC = Super Cut

Lexer-Baby

straight	curved
26-6155	26-6156
10.5 cm/4"	10.5 cm/4"

Stevens

blunt	curved
straight	curved
26-6160	26-6161
11 cm/4¼"	11 cm/4¼"
26-6160.SC	26-6161.SC

pointed	curved
straight	curved
26-6162	26-6163
11 cm/4¼"	11 cm/4¼"
26-6162.SC	26-6163.SC



Reynolds

Jameson (delicate tip)
curved

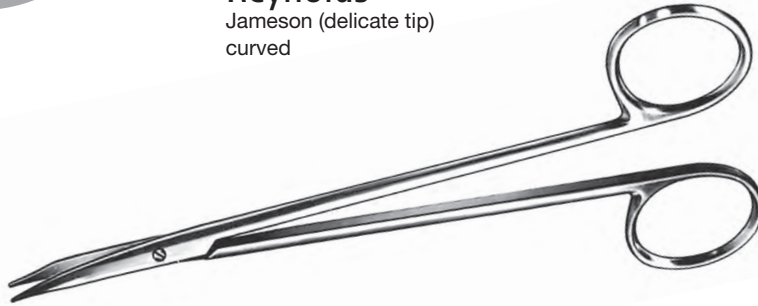

Ragnell-Kilner

curved



■ SC = Super Cut

**Reynolds, curved
regular tip**

26-6250	26-6252	26-6254	26-6256	26-6258	26-6239	26-6255
13.5 cm	15 cm	18 cm	20 cm	23 cm	15 cm	18 cm
26-6250.SC	26-6252 .SC	26-6254 .SC	26-6256 .SC	26-6258 .SC	26-6239 .SC	26-6255.SC

**Jameson, curved
delicate tip**

Ragnell-Kilner, curved

26-6170	26-6172	26-6174	26-6176
12.5 cm	15 cm	18 cm	20 cm
26-6170.SC	26-6172.SC	26-6174.SC	26-6176.SC

Standard, straight

	10.5 cm	11.5 cm	13.0 cm	14.5 cm	15.5 cm	16.5 cm	17.5 cm	18.5 cm	20.0 cm
A	26-6020	26-6022	26-6024	26-6026	26-6028	26-6030	26-6032	26-6034	26-6036
B	26-6040	26-6042	26-6044	26-6046	26-6048	26-6050	26-6052	26-6054	26-6056
C	26-6060	26-6062	26-6064	26-6066	26-6068	26-6070	26-6072	26-6074	26-6076

Standard, curved

	10.5 cm	11.5 cm	13.0 cm	14.5 cm	15.5 cm	16.5 cm	17.5 cm	18.5 cm	20.0 cm
A	26-6021	26-6023	26-6025	26-6027	26-6029	26-6031	26-6033	26-6035	26-6037
B	26-6041	26-6043	26-6045	26-6047	26-6049	26-6051	26-6053	26-6055	26-6057
C	26-6061	26-6063	26-6065	26-6067	26-6069	26-6071	26-6073	26-6075	26-6077

Standard

straight, curved



Mayo



■ SC = Super Cut

**Mayo
straight**

26-6100	26-6102	26-6104	26-6106	26-6108
14.5 cm	15.5 cm	17 cm	21 cm	23 cm
26-6100.SC	26-6102.SC	26-6104.SC	26-6106.SC	26-6108.SC

curved

26-6110	26-6112	26-6114	26-6116	26-6118
14.5 cm	15.5 cm	17 cm	21 cm	23 cm
26-6110.SC	26-6112.SC	26-6114.SC	26-6116.SC	26-6118.SC



Mayo-Harrington

Mc Indoe (UK)

Mayo-Lexer

Lexer-Fino



■ SC = Super Cut

Mayo-Harrington

straight	curved
26-6120	26-6121
22.5 cm/8¾"	22.5 cm/8¾"
26-6120.SC	26-6121.SC
26-6122	26-6123
28 cm/11"	28 cm/11"
26-6122.SC	26-6123.SC

Mc Indoe (UK)

26-6301
18 cm/7"
26-6301.SC

Mayo-Lexer

straight	curved
26-6140	26-6141
16 cm/6¼"	16 cm/6¼"
26-6140.SC	26-6141.SC
26-6142	26-6143
21 cm/8¼"	21 cm/8¼"

Lexer-Fino

delicate straight	curved
26-6150	26-6151
16 cm/6¼"	16 cm/6¼"
26-6150.SC	26-6151.SC

Mayo-Stillle



■ SC = Super Cut

Mayo-Stillle

straight

26-6130	26-6132
15 cm/6"	17 cm/6½"
26-6130.SC	26-6132.SC

curved

26-6131	26-6133
15 cm/6"	17 cm/6½"
26-6131.SC	26-6133.SC



■ SC = Super Cut

**Spencer
Ligature Scissors**

26-6760
9 cm/3½"

26-6762
10.5 cm/4"

26-6764
12.5 cm/4½"

**Littauer
Ligature Scissors**

26-6750
14 cm/5½"

**Lister
Bandage Scissors**

26-4970 26-4971
9 cm/3½" 11 cm/4½"
26-4970.SC 26-4971.SC

26-4972 26-4974
14 cm/5½" 18 cm/7"
26-4972.SC 26-4974.SC

26-4975
20 cm/8"
26-4975.SC

**Umbilical
Cord Scissors**

26-6936 26-6937
13.5 cm/5" 16 cm/6¼"

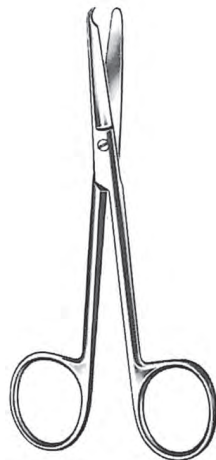

Spencer
Ligature Scissors



Littauer
Ligature Scissors

Lister
Bandage Scissors

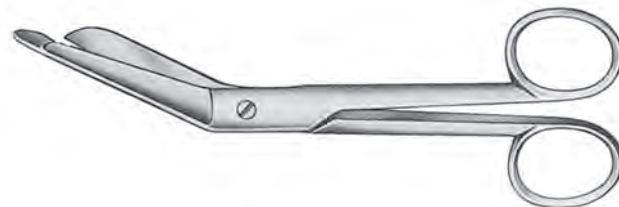

Umbilical
Cord Scissors





Sims Gyn.



Doyen
Abdominal Scissors

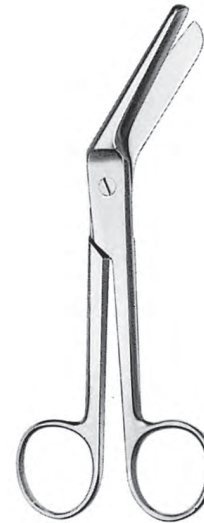

Braun-Stadler

■ SC = Super Cut

Sims Gyn.

straight	curved
26-6880	26-6881
20 cm/8"	20 cm/8"
26-6883	26-6884
23 cm/9"	23 cm/9"

Doyen

Abdominal Scissors

straight	curved
26-6908	26-6909
16 cm/6¼"	16 cm/6¼"
26-6910	26-6911
18 cm/7"	18 cm/7"
26-6910.SC	26-6911.SC

Braun-Stadler

26-6900	26-6901
14 cm/5½"	22 cm/8½"
	26-6901.SC



Bailey

Vascular Rongeurs



Luc's

Nibbling Forceps



Bailey Vascular Rongeurs

Art.-No.	✂		Length
40-2600	straight	3mm	12 cm/4¾"
40-2602	25° down	3mm	12 cm/4¾"
40-2604	70° down	3mm	12 cm/4¾"
40-2606	90° down	3mm	12 cm/4¾"
40-2608	45° left	3mm	12 cm/4¾"
40-2610	45° right	3mm	12 cm/4¾"

Longer shaft length on special request

Luc's Nibbling Forceps

Art.-No.	Length
40-8010	19 cm/7½"



Gigli

Wire Saw Handle



Gigli

Wire Saw



Gigli

Introducer Guide



Gigli
Wire Saw Handle
Art.-No.
 26-9109

Gigli Wire Saw Art.-No.	Length
26-9110	30 cm/12"
26-9111	40 cm/16"
26-9112	50 cm/20"
26-9113	60 cm/24"
26-9114	70 cm/28"

Gigli
Introducer Guide
Art.-No.
 26-9105

Bethune



Art.-No.	Length
26-6920	23 cm/9"
26-6925	21 cm/8¼"

Bethune	Length
Art.-No.	40-0235
	35 cm/14"



Coryllos-Bethune



Coryllos-Bethune



Coryllos-Bethune
Art.-No. Length
 40-0240 36 cm/14"
 Right protected jaws

Coryllos-Bethune
Art.-No. Length
 40-0241 36 cm/14"
 Left protected jaws

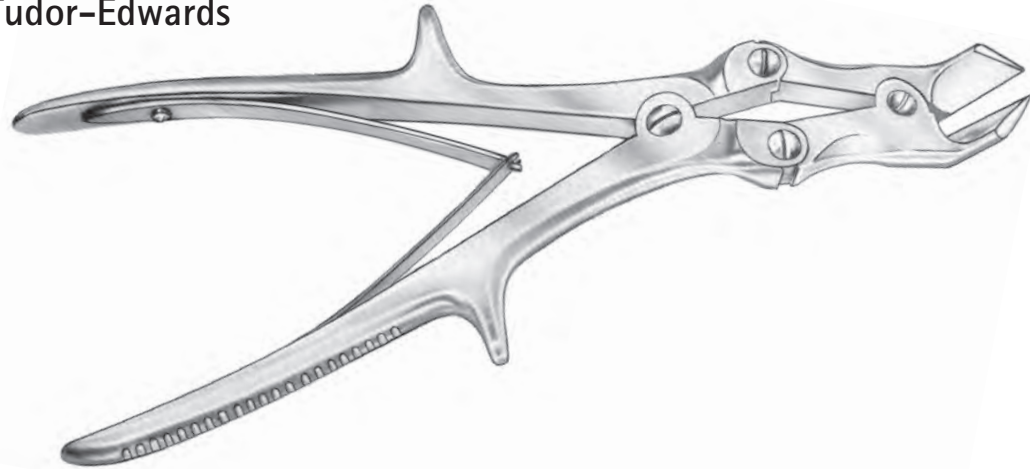
Tudor-Edwards**Costotome****Tudor-Edwards****S-curved**

Art.-No.	Length
40-0232	26 cm/10¼"

Costotome

Art.-No.	Length
40-0283	24 cm/9½"

Sauerbruch**Giertz-Stille****Sauerbruch****Art.-No.**

40-0282

Length

26 cm/10¼"

Grietz-Stille**Art.-No.**

40-0285

Length

27 cm/10½"



Boehler

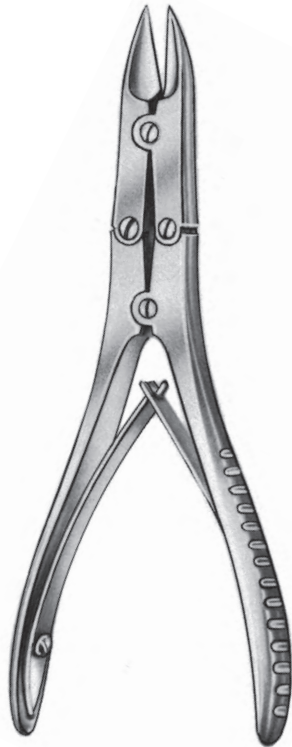

Mc Indoe

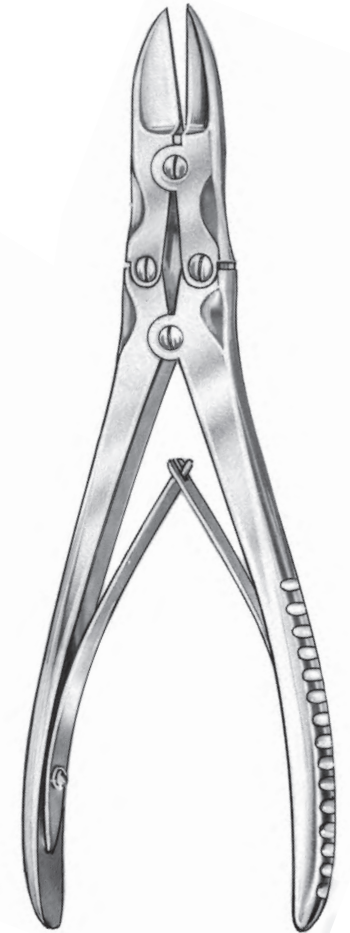

Ruskin-Liston

**Boehler**

straight 15 cm 40-0200

curved 15 cm 40-0201

Mc Indoe

18 cm 40-0205

Ruskin-Liston

straight 19 cm 40-0210

curved 19 cm 40-0211



Boehler



Luer-Stille



A

B

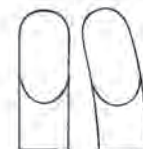

C

D

Boehler

15 cm 2 mm
 15 cm 3 mm
 15 cm 4 mm

A

40-0098
 40-0100
 40-0102

B

40-0099
 40-0101
 40-0103

Luer-Stille

22 cm 10 mm

C

40-0150

D

40-0151



Bone Biting Rongeurs

Beyer



Ruskin

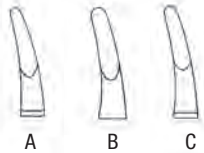

Marquardt

**Beyer**

A		
18 cm	3 mm	40-0104
18 cm	4 mm	40-0105

Ruskin

B		
19 cm	4 mm	40-0115
19 cm	5 mm	40-0116
19 cm	6 mm	40-0117

Marquardt

C		
20 cm	3 mm	40-0190

Smith-Peterson



Leksell

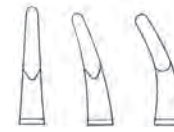

A

B

C



D, slight bent/strong bent

Smith-Peterson

		A	B	C
19 cm	3 mm	40-0180	40-0181	40-0182
23 cm	3 mm	40-0185	40-0186	40-0187
23 cm	4 mm	40-0185.40	40-0186.40	40-0187.40

Leksell

D		slight bent	strong bent
23 cm	3 mm	40-0124	
23 cm	5 mm	40-0126	40-0128
23 cm	8 mm	40-0125	40-0127