



Wundhaken
Retractors

Ecarteurs
Separadores
Divaricatori



Nasenhäkchen
Nasal hooks

Crochets nasales
Ganchitos nasales
Uncini nasali



KILNER
150 mm – 6"
tk 48128-15



JOSEPH
150 mm – 6"
tk 16900-15



LANGE
220 mm – 8¾"
tk 16901-22



COTTLE
160 mm – 6¼"
tk 16902-16



FOMON
170 mm – 6¾"
tk 16904-17





COTTLE
150 mm – 6"  1:1  1:1  1:1
tk 16905-01 tk 16905-02 tk 16905-03



Nasenhäkchen
Nasal hooks

Crochets nasales
Ganchitos nasales
Uncini nasali







ITERSON		
160 mm – 6¼"	 1:1 tk 16920-16	 1:1 tk 16922-16
	scharf sharp pointu agudo acuto	stumpf blunt mousse romo smusso



GILLIES		
	 1:1 Fig. 1	 1:1 Fig. 2
180 mm – 7"	tk 48130-01	tk 48130-02



JOSEPH				
	 1:1	 1:1	 1:1	 1:1
	2 mm	5 mm	7 mm	10 mm
160 mm – 6¼"	tk 16910-02	tk 16910-05	tk 16910-07	tk 16910-10

Nasenhäkchen
Nasal hooks

Crochets nasales
Ganchitos nasales
Uncini nasali



**COTTLE-
NEIVERT**

200 mm – 8"

tk 16912-20

1:2



FOMON

160 mm – 6¼"

tk 16914-16

1:2



COTTLE

150 mm – 6"



1:1

tk 16915-01



1:1

tk 16915-02



1:1

tk 16915-03

1:2



NEIVERT

160 mm – 6¼"

tk 16916-16

1:2

Nasen- und Trachealhäkchen
Trachea and nose retractors

Ecarteurs nasales et tracheales
Separadores traqueales y nasales
Uncini tracheali e nasali



COTTLE

1:2

1:2

150 mm – 6"

tk 16917-15

tk 16918-15

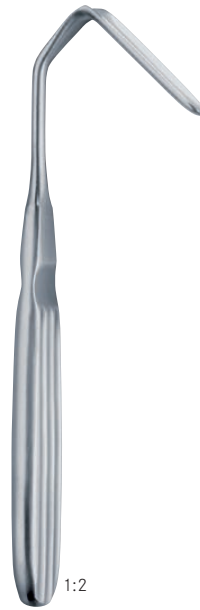

1:2

AUFRICHT

190 mm – 6¼"

tk 16906-19



1:2

KILNER

100 mm – 4"

tk 16907-10



1:2

CONVERSE

120 mm – 4¾"

tk 16908-12

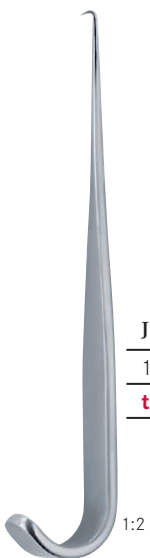

1:2

JACKSON

150 mm – 6"

tk 16930-15

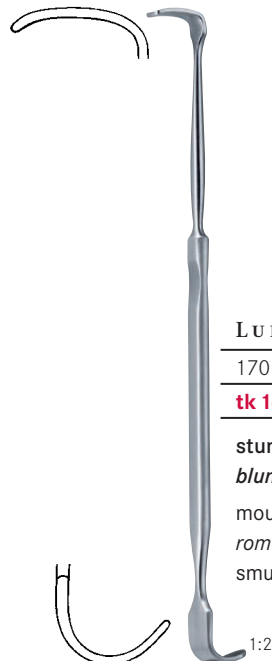

1:2

LUKENS

170 mm – 6⅔"

tk 16933-17

stumpf

blunt

mousse

romo

smusso

Trachealhäkchen
Trachea retractors

Ecarteurs tracheales
Separadores traqueales
Uncini tracheali

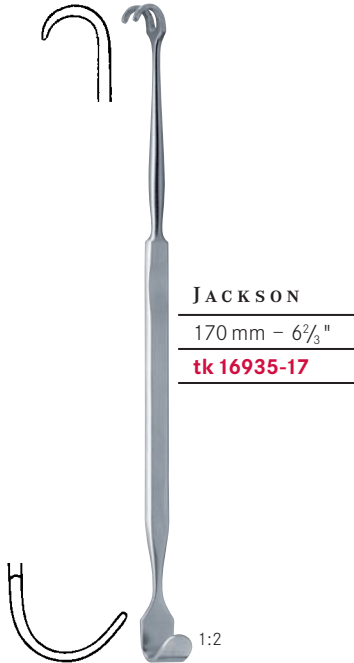

JACKSON

170 mm – 6 $\frac{2}{3}$ "

tk 16935-17



JACKSON

180 mm – 7"

tk 16937-18

tk 16939-18

stumpf

scharf

blunt

sharp

mousse

pointu

romo

agudo

smusso

acuto

Wundhaken
Retractors

Ecarteurs
Separadores
Divaricatori



ROSE

130 mm – 5"

tk 16950-13



LUER

110 mm – 4 $\frac{1}{4}$ "

tk 16952-11



SCHOENBORN





210 mm – 8 $\frac{1}{4}$ "

tk 16955-21





Wundhaken
Retractors

Ecarteurs
Separadores
Divaricatori







EMMET	 1:1	 1:1	 1:1	 1:1	 1:1
	Fig. 1	Fig. 2	Fig. 3	Fig. 4	Fig. 5
	220 mm – 8 ³ / ₄ "	tk 16958-01	tk 16958-02	tk 16958-03	tk 16958-04

1:2

scharf sharp pointu agudo acuto	 1:1	 1:1	 1:1	 1:1	
	160 mm – 6 ¹ / ₄ "	tk 17001-16	tk 17002-16	tk 17003-16	tk 17004-16

1:2

stumpf blunt mousse romo smusso	 1:1	 1:1	 1:1	 1:1	
	160 mm – 6 ¹ / ₄ "	tk 17011-16	tk 17012-16	tk 17013-16	tk 17014-16

Wundhaken | Ecarteurs
 Retractors | Separadores
 Divaricatori



1:2



1:1



1:1



1:1

160 mm – 6¼"	tk 17021-16	tk 17022-16	tk 17024-16
--------------	--------------------	--------------------	--------------------

flexibel, scharf
flexible, sharp
 flexible, pointu
flexible, agudo
 flessibile, acuto

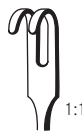

1:1



1:1



1:1



160 mm – 6¼"	tk 17031-16	tk 17032-16	tk 17034-16
--------------	--------------------	--------------------	--------------------



flexibel, stumpf
flexible, blunt
 flexible, mousse
flexible, romo
 flessibile, smusso



1:2

1:1

DESMARRES	 1:1	 1:1	 1:1
	x = 8 mm	x = 10 mm	x = 12 mm
160 mm – 6¼"	tk 17038-08	tk 17038-10	tk 17038-12

	 1:1	 1:1	 1:1
	x = 14 mm	x = 16 mm	x = 18 mm
160 mm – 6¼"	tk 17038-14	tk 17038-16	tk 17038-18



1:2

**KNAPP
 (ROLLET)**
 160 mm – 6¼"

tk 17025-16
 flexibel, scharf
flexible, sharp
 flexible, pointu
flexible, agudo
 flessibile, acuto

Wundhaken | Ecarteurs
 Retractors | Separadores
 Divaricatori



MINI-LANGENBECK



	10 mm x 6 mm	17 mm x 5 mm	20 mm x 6 mm	22 mm x 8 mm
160 mm – 6¼" 1:2	tk 17039-10	tk 17039-17	tk 17039-20	tk 17039-22



KOCHER

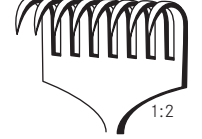
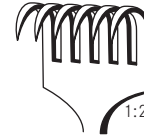
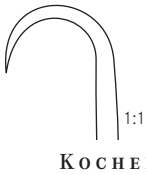

220 mm – 8¾" 1:2	tk 17041-22	tk 17042-22	tk 17043-22	tk 17044-22	tk 17046-22	tk 17048-22
-------------------------	--------------------	--------------------	--------------------	--------------------	--------------------	--------------------

scharf
 sharp
 pointu
 agudo
 acuto

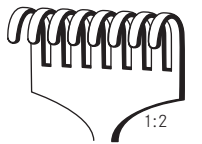
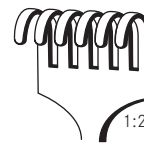
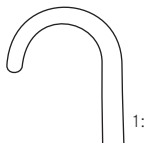

220 mm – 8¾" 1:2	tk 17051-22	tk 17052-22	tk 17053-22	tk 17054-22	tk 17056-22	tk 17058-22
-------------------------	--------------------	--------------------	--------------------	--------------------	--------------------	--------------------

stumpf
 blunt
 mousse
 romo
 smusso

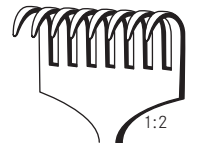
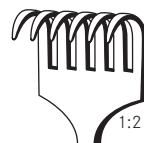
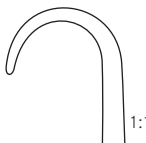

220 mm – 8¾" 1:2	tk 17059-01	tk 17059-02	tk 17059-03	tk 17059-04	tk 17059-06	tk 17059-08
-------------------------	--------------------	--------------------	--------------------	--------------------	--------------------	--------------------

halbscharf
 semi-sharp
 semi-pointu
 semi-agudo
 semi-acuto

Wundhaken | Ecarteurs
 Retractors | Separadores
 Divaricatori



1:2



1:1

VOLKMANN

215 mm – 8½"



1:2

tk 17061-21



1:2

tk 17062-21



1:2

tk 17063-21



1:2

tk 17064-21



1:2

tk 17066-21

scharf
 sharp
 pointu
 agudo
 acuto

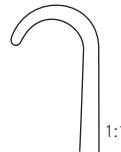

1:1

215 mm – 8½"



1:2

tk 17071-21



1:2

tk 17072-21



1:2

tk 17073-21



1:2

tk 17074-21

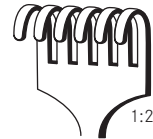

1:2

tk 17076-21

stumpf
 blunt
 mousse
 romo
 smusso

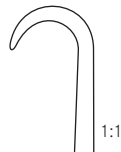

1:1

215 mm – 8½"



1:2

tk 17078-01



1:2

tk 17078-02



1:2

tk 17078-03



1:2

tk 17078-04



1:2

tk 17078-06

halbscharf
 semi-sharp
 semi-pointu
 semi-agudo
 semi-acuto

Wundhaken
Retractors

Ecarteurs
Separadores
Divaricatori



VOLKMANN

215 mm – 8½" "

scharf
sharp
pointu
agudo
acuto

tk 17040-01

stumpf
blunt
mousse
romo
smusso

tk 17040-02

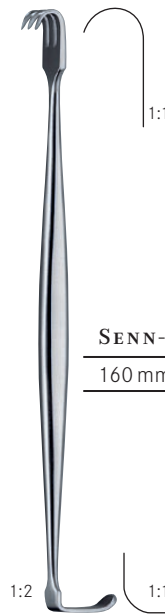
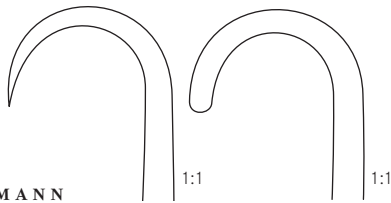

SENN-MUELLER

160 mm – 6¼" "

scharf
sharp
pointu
agudo
acuto

tk 17080-16

stumpf
blunt
mousse
romo
smusso

tk 17081-16

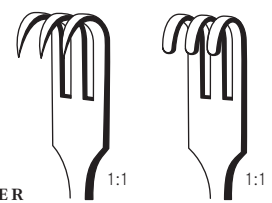

KILNER

155 mm – 6" "

tk 17082-15

13 mm x 5 mm



Wundhaken
Retractors

Ecarteurs
Separadores
Divaricatori



STRANDELL-
STILLE

	20 mm x 6 mm	20 mm x 6 mm
190 mm – 7½"	tk 17079-01	tk 17079-02

gezahnt
saw edge
dentelé
dentado
dentato

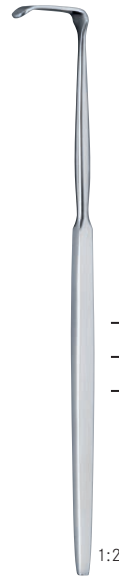

SENN-GREEN

	20 mm x 6 mm	10 mm x 6 mm
150 mm – 6"	tk 17083-01	tk 17083-02

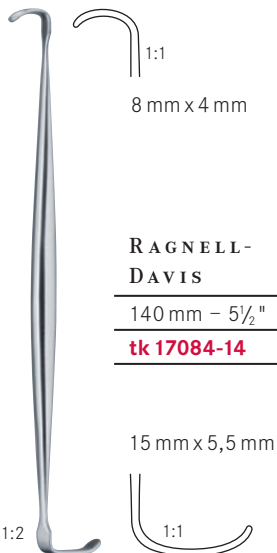

RAGNELL-
DAVIS

140 mm – 5½"
tk 17084-14

15 mm x 5,5 mm



COTTLE

150 mm – 6"
tk 17085-15

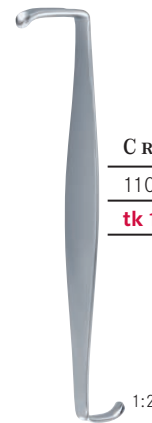

CRILE

110 mm – 4¼"
tk 17088-11

Wundhaken
Retractors

Ecarteurs
Separadores
Divaricatori

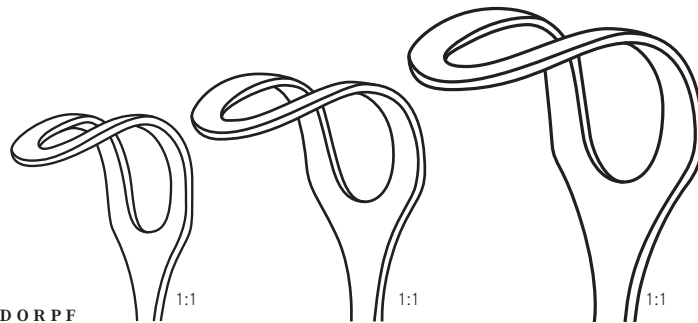

MIDDELDORPF

14 mm x 17 mm	20 mm x 22 mm	26 mm x 30 mm
215 mm – 8½"	220 mm – 8¾"	235 mm – 9¼"
tk 17085-21	tk 17086-22	tk 17087-23



MEYERDING



18 mm x 7 mm	10 mm x 3 mm
180 mm – 7"	tk 17090-18
	tk 17091-18



16 mm x 5 mm	7 mm x 4 mm
180 mm – 7"	tk 17092-18
	tk 17093-18

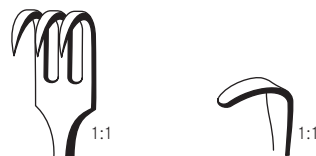

10 mm x 4 mm	7 mm x 4 mm
180 mm – 7"	tk 17094-18
	tk 17095-18

1:2

Wundhaken | Ecarteurs
 Retractors | Separadores
 Divaricatori



1:2

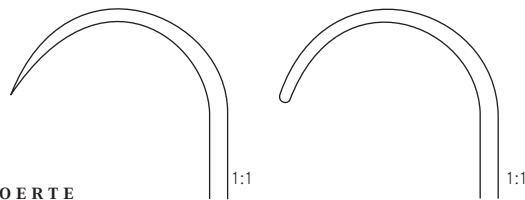

KOERTE		
	26 mm x 40 mm	26 mm x 40 mm
235 mm – 9¼"	tk 17096-08	tk 17097-08

scharf
sharp
 pointu
 agudo
 acuto

stumpf
blunt
 mousse
 romo
 smusso



1:2

GREEN	
215 mm – 8½"	tk 17099-21

Wundhaken
Retractors

Ecarteurs
Separadores
Divaricatori

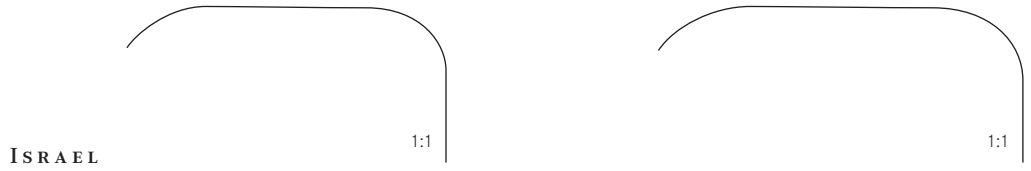
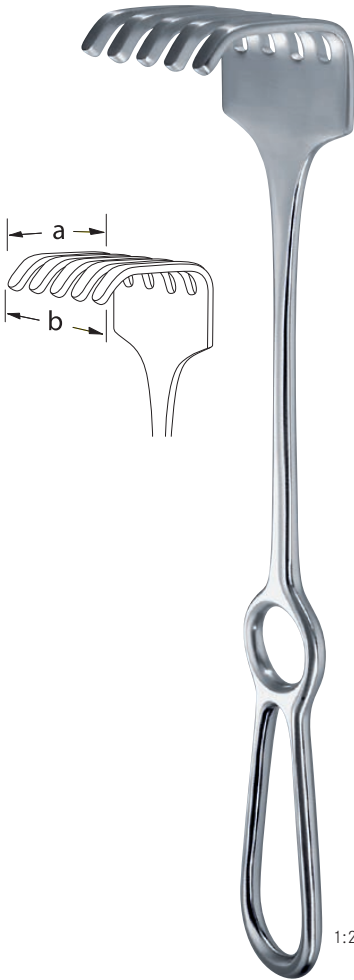

ISRAEL	a = 40 mm – b = 40 mm	a = 45 mm – b = 50 mm
250 mm – 9 3/4"	tk 17100-25	tk 17101-25

4 Zähne
4 Teeth
4 Dents
4 Dientes
4 Denti

5 Zähne
5 Teeth
5 Dents
5 Dientes
5 Denti

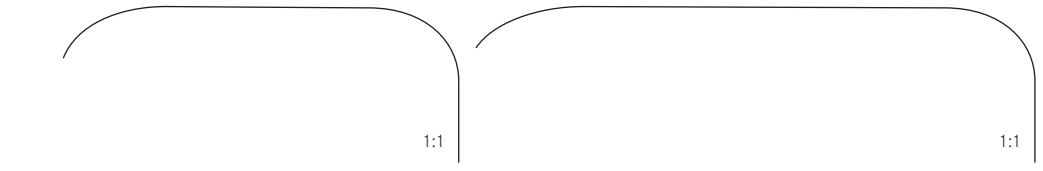

	a = 50 mm – b = 60 mm	a = 70 mm – b = 70 mm
250 mm – 9 3/4"	tk 17102-25	tk 17103-25

6 Zähne
6 Teeth
6 Dents
6 Dientes
6 Denti

6 Zähne
6 Teeth
6 Dents
6 Dientes
6 Denti



LANGENBECK	Fig. 1	Fig. 2	Fig. 3
	30 mm x 11 mm	30 mm x 14 mm	30 mm x 16 mm
220 mm – 8 3/4"	tk 17110-01	tk 17110-02	tk 17110-03







	Fig. 4	Fig. 5
	40 mm x 11 mm	50 mm x 11 mm
220 mm – 8 3/4"	tk 17110-04	tk 17110-05

Wundhaken | Ecarteurs
 Retractors | Separadores
 Divaricatori



LANGENBECK





	 1:1	 1:1	 1:1
	Fig. 1	Fig. 2	Fig. 3
	30 mm x 11 mm	30 mm x 14 mm	30 mm x 16 mm
210 mm – 8¼"	tk 17112-01	tk 17112-02	tk 17112-03



	 1:1	 1:1
	Fig. 4	Fig. 5
	40 mm x 11 mm	50 mm x 11 mm
210 mm – 8¼"	tk 17112-04	tk 17112-05

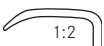

1:2



KOCHER-LANGENBECK (OBWEGESER)

	 1:2	 1:2	 1:2	 1:2
	25 mm x 7 mm	35 mm x 8 mm	35 mm x 11 mm	35 mm x 15 mm
215 mm – 8½"	tk 17114-01	tk 17114-02	tk 17114-03	tk 17114-04

	 1:2	 1:2	 1:2
	42 mm x 10 mm	55 mm x 12 mm	70 mm x 14 mm
215 mm – 8½"	tk 17114-05	tk 17114-06	tk 17114-07

	 1:2	 1:2
	80 mm x 12 mm	80 mm x 16 mm
215 mm – 8½"	tk 17114-08	tk 17114-09

1:2

Wundhaken
Retractors

Ecarteurs
Separadores
Divaricatori



CUSHING



	x = 8 mm	x = 10 mm	x = 12 mm	x = 14 mm	x = 16 mm	x = 18 mm
200 mm – 8"	tk 17200-08	tk 17200-10	tk 17200-12	tk 17200-14	tk 17200-16	tk 17200-18
240 mm – 9½"	tk 17201-08	tk 17201-10	tk 17201-12	tk 17201-14	tk 17201-16	tk 17201-18



OBWEGESER

	42 mm x 13 mm	60 mm x 12 mm
220 mm – 8¾"	tk 52715-01	tk 52715-02

	80 mm x 16 mm
220 mm – 8¾"	tk 52715-03

Wundhaken
Retractors

Ecarteurs
Separadores
Divaricatori



OBWEGESER	1:1	1:1
	44 mm x 9,5 mm	70 mm x 11,5 mm
220 mm – 8¾"	tk 52717-22	tk 52719-22

1:2

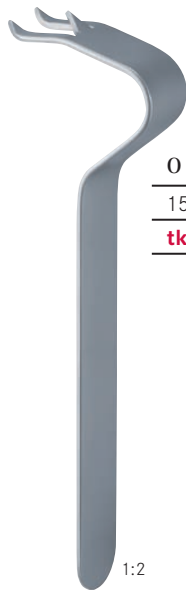

OBWEGESER
155 mm – 6"
tk 52723-16

1:2



OBWEGESER	x = 8 mm	x = 10 mm
160 mm – 6¼"	tk 52725-08	tk 52725-10

biegsam
malleable
malléable
maleable
flessibile

1:2

Wundhaken
Retractors

Ecarteurs
Separadores
Divaricatori

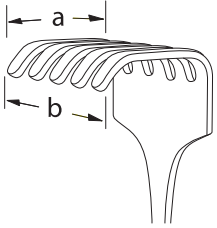

OLLIER

	a = 36 mm – b = 30 mm	a = 36 mm – b = 60 mm
225 mm – 8¾" 1:2	tk 17105-03	tk 17105-04



KOCHER

	55 mm x 11 mm	40 mm x 12 mm
210 mm – 8¼" 1:2	tk 17115-21	tk 17116-21

Wundhaken
Retractors

Ecarteurs
Separadores
Divaricatori



1:2

LANGENBECK

	60 mm x 20 mm
210 mm – 8¼"	tk 17117-60



1:2

LANGENBECK

	85 mm x 15 mm
210 mm – 8¼"	tk 17117-85



Griff vertikal zum Blatt
Handle vertical to the blade

Poignée verticale à la lame
Mango vertical a la hoja

Manico verticale verso la lama

Wundhaken
Retractors

Ecarteurs
Separadores
Divaricatori

SAUERBRUCH		
	1:1	
	45 mm x 15 mm	75 mm x 20 mm
225 mm – 8¾" "	tk 17120-22	tk 17121-22

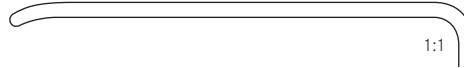
	1:1
	60 mm x 23 mm
220 mm – 8¾" "	tk 17122-22

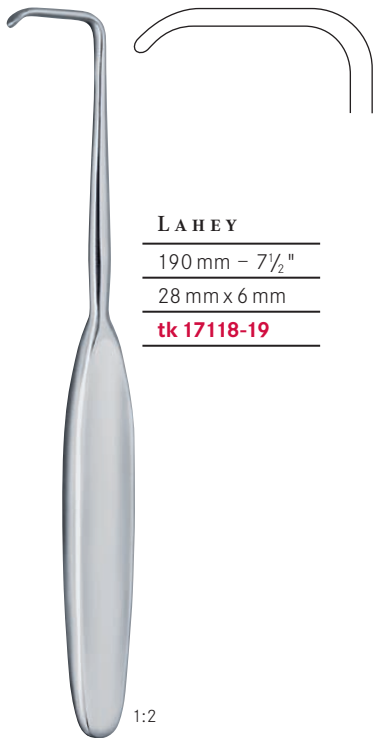
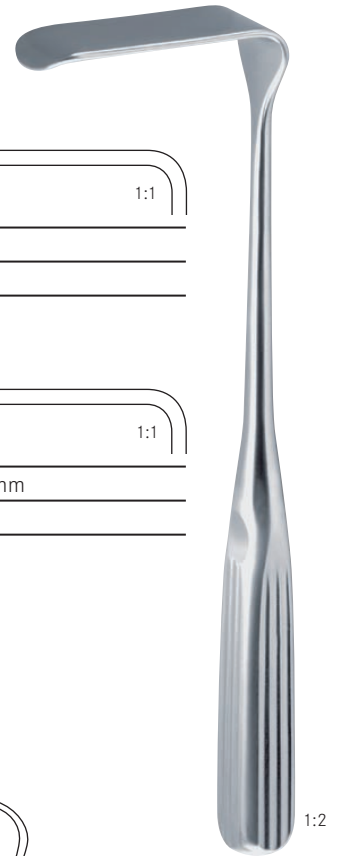



LAHEY
190 mm – 7½" "
28 mm x 6 mm
tk 17118-19

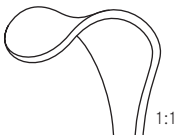
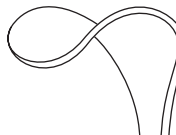

KOCHER		
	1:1	
	19 mm x 12 mm	21 mm x 14 mm
190 mm – 7½" "	tk 17125-01	tk 17125-02

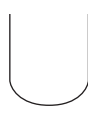



KOCHER			
			
	40 mm x 10 mm	40 mm x 15 mm	40 mm x 20 mm
220 cm – 8¾" "	tk 17127-01	tk 17127-02	tk 17127-03

Wundhaken | Ecarteurs
 Retractors | Separadores
 Divaricatori

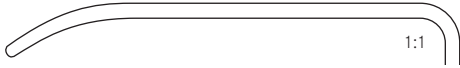

KOCHER	 1:1	 1:1
	40 mm x 18 mm	60 mm x 20 mm
230 mm – 9"	tk 17128-18	tk 17128-20

	 1:1	 1:1
	60 mm x 25 mm	75 mm x 30 mm
230 mm – 9"	tk 17128-25	tk 17128-30

	 1:1
	75 mm x 40 mm
230 mm – 9"	tk 17128-40

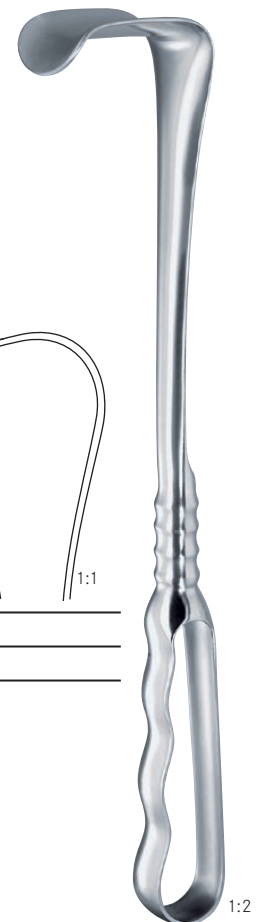
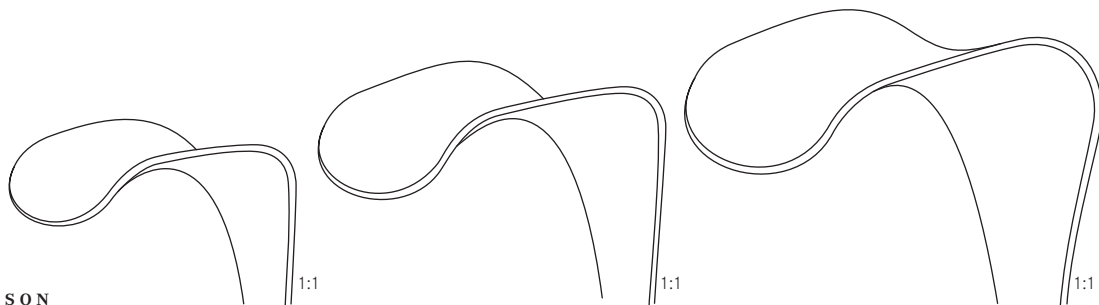

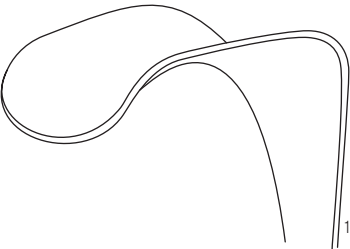
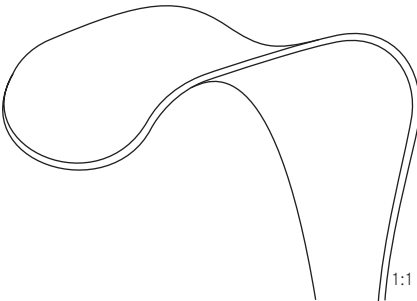
RICHARDSON	 1:1	 1:1	 1:1
	28 mm x 20 mm	36 mm x 28 mm	44 mm x 38 mm
240 mm – 9½"	tk 17130-24	tk 17131-24	tk 17132-24

Wundhaken
Retractors

Ecarteurs
Separadores
Divaricatori



RICHARDSON-EASTMAN

	Fig. 1	Fig. 2
	280 mm – 11 "	260 mm – 10 1/4 "
	49 mm x 38 mm	36 mm x 28 mm
	63 mm x 49 mm	28 mm x 20 mm
tk 17135-01	x	
tk 17135-02		x
tk 17135-00	x	x



RICHARDSON

240 mm – 9 1/2 "
52 mm x 22 mm
tk 17133-24



KELLY

260 mm – 10 1/4 "
65 mm x 50 mm
tk 17134-26

Wundhaken | Ecarteurs
 Retractors | Separadores
 Divaricatori



HOESEL
 260 mm – 10¼"

1:2

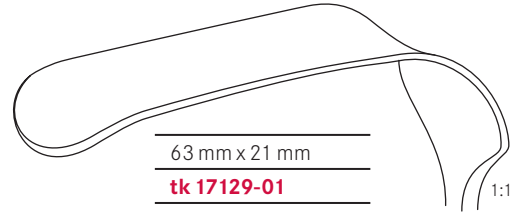

63 mm x 21 mm
tk 17129-01

1:1

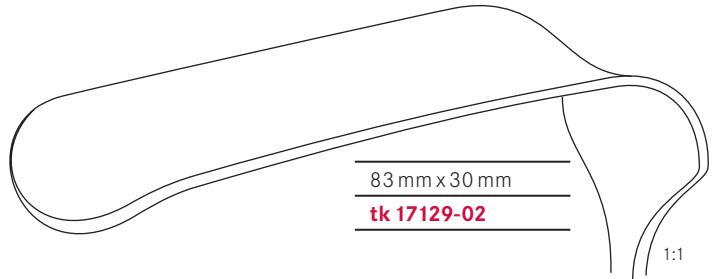

83 mm x 30 mm
tk 17129-02

1:1

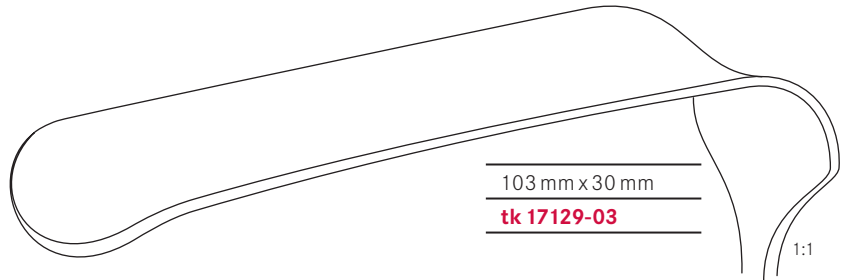

103 mm x 30 mm
tk 17129-03

1:1

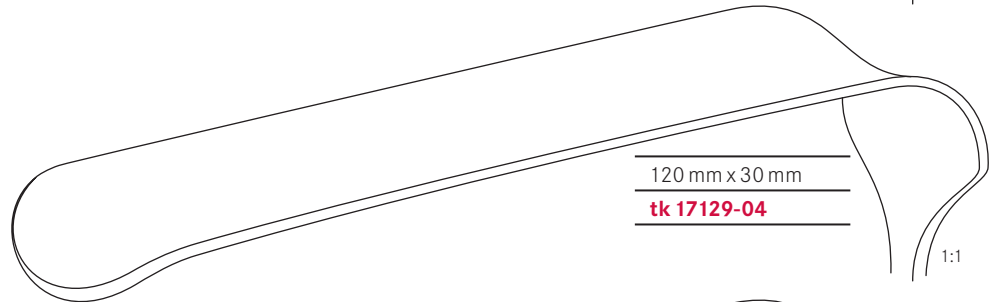

120 mm x 30 mm
tk 17129-04

1:1

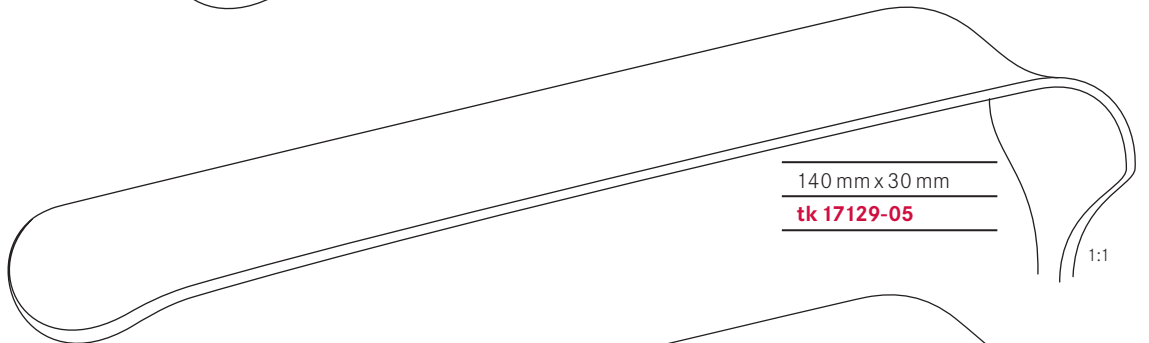

140 mm x 30 mm
tk 17129-05

1:1

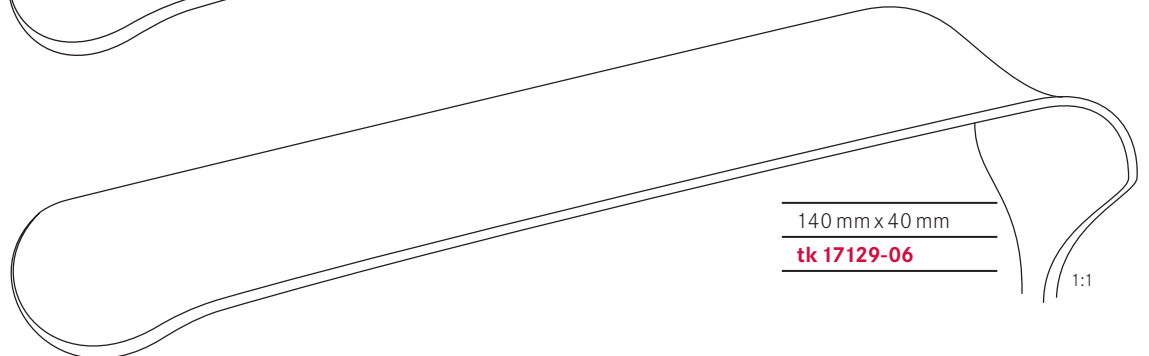

140 mm x 40 mm
tk 17129-06

1:1

Wundhaken
Retractors

Ecarteurs
Separadores
Divaricatori

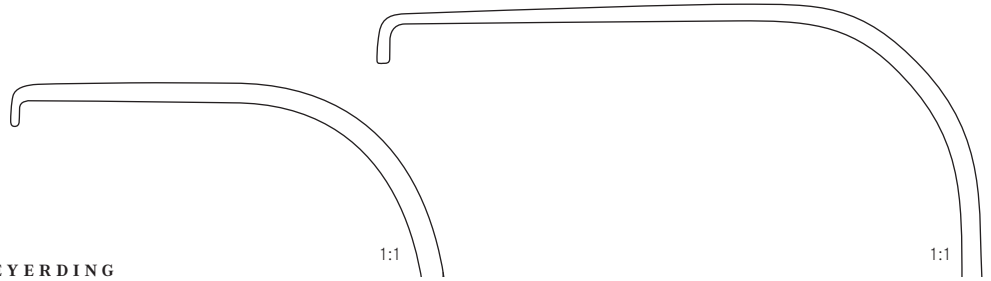

MEYERDING

200 mm – 8"	220 mm – 8 ³ / ₄ "
50 mm x 16 mm	75 mm x 25 mm
tk 17140-20	tk 17141-22

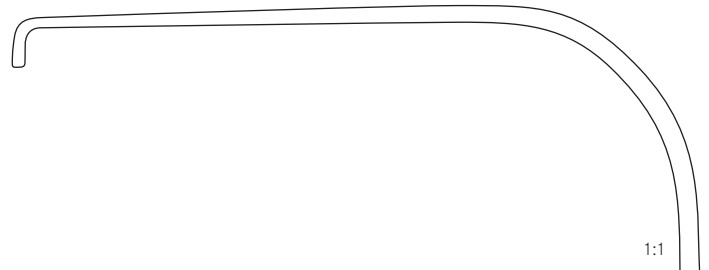

240 mm – 9 ¹ / ₂ "
90 mm x 50 mm
tk 17142-24

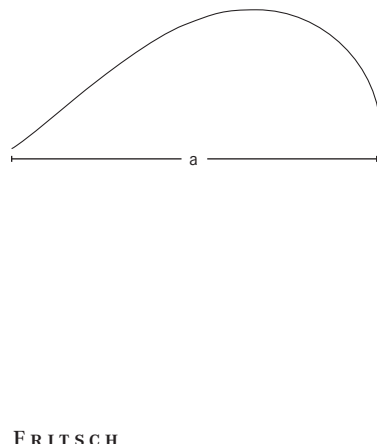

FRITSCH

235 mm – 9 ¹ / ₄ "	a = 37 mm – b = 31 mm	tk 17150-24
240 mm – 9 ¹ / ₂ "	a = 38 mm – b = 40 mm	tk 17151-24
250 mm – 9 ³ / ₄ "	a = 43 mm – b = 51 mm	tk 17152-24
250 mm – 9 ³ / ₄ "	a = 49 mm – b = 61 mm	tk 17153-24
255 mm – 10"	a = 48 mm – b = 75 mm	tk 17154-24
265 mm – 10 ¹ / ₂ "	a = 65 mm – b = 85 mm	tk 17155-24

Wundhaken
Retractors

Ecarteurs
Separadores
Divaricatori



SIMON		
	115 mm x 22 mm	115 mm x 27 mm
280 cm – 11 "	tk 17160-28	tk 17161-28

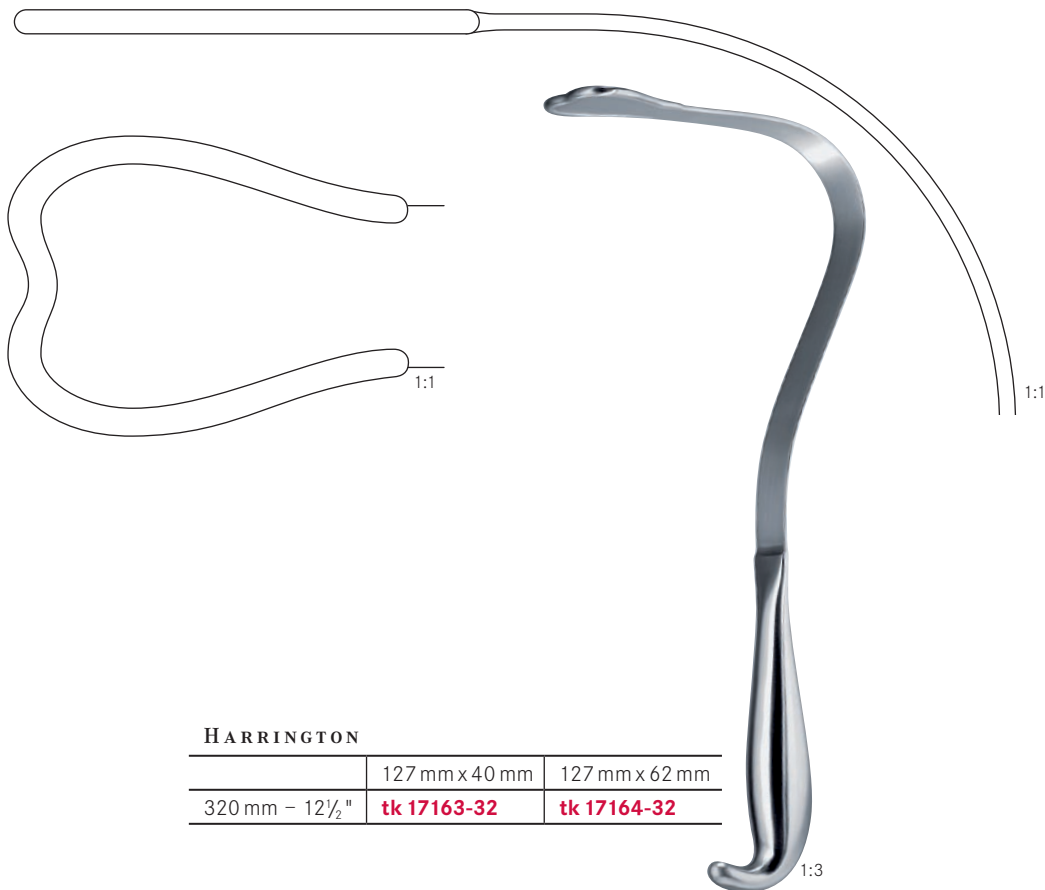

HARRINGTON		
	127 mm x 40 mm	127 mm x 62 mm
320 mm – 12½ "	tk 17163-32	tk 17164-32

Wundhaken
Retractors

Ecarteurs
Separadores
Divaricatori



1:2

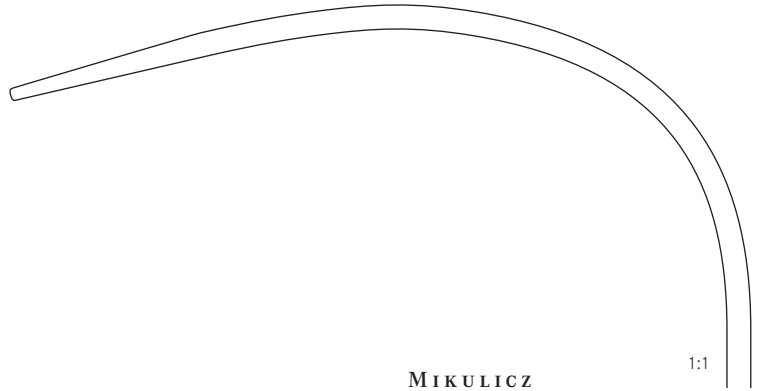

1:1

MIKULICZ

	95 mm x 35 mm
260 mm – 10 3/4"	tk 17170-26

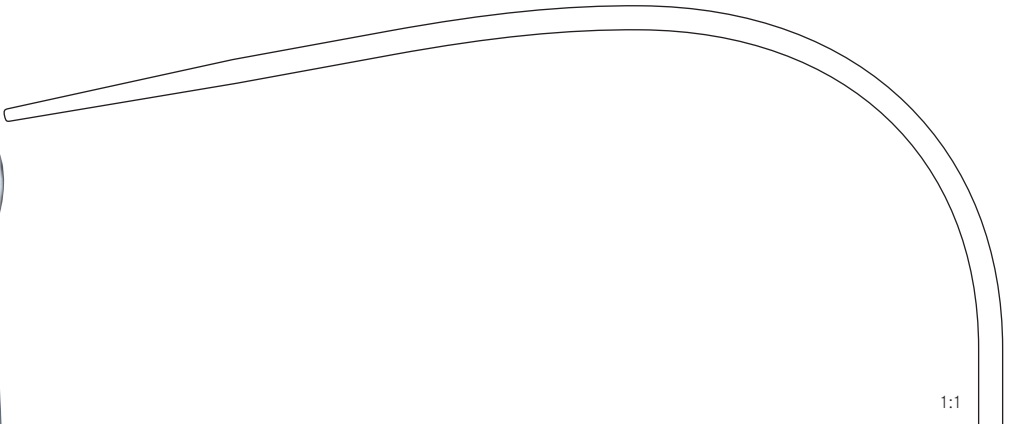

1:1

120 mm x 50 mm
tk 17171-26

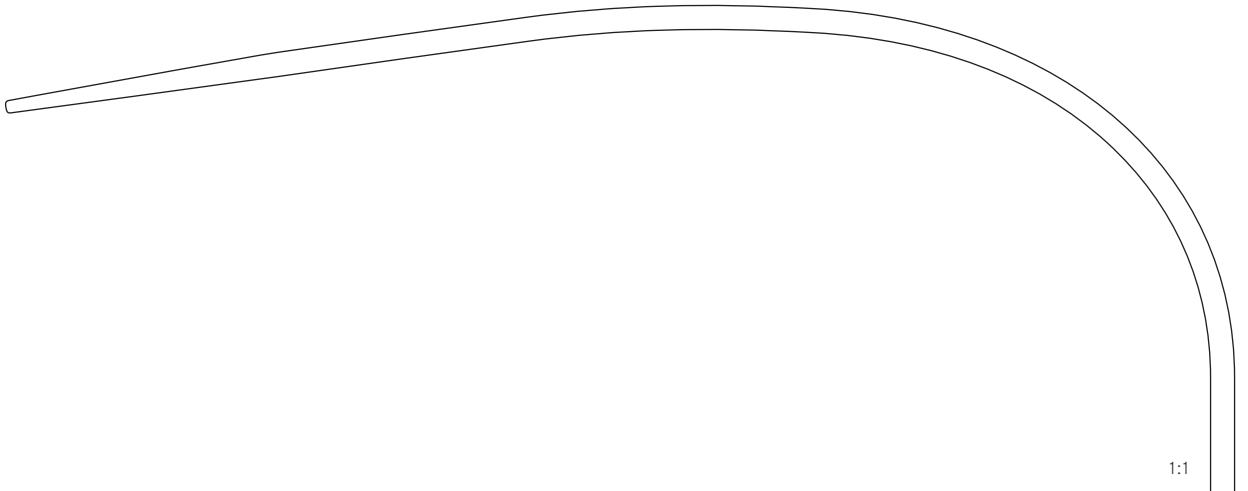

1:1

150 mm x 50 mm
tk 17172-26

Wundhaken | Ecarteurs
 Retractors | Separadores
 Divaricatori



MIKULICZ

260 mm – 10 1/4"

90 mm x 50 mm

tk 17174-26

1:2

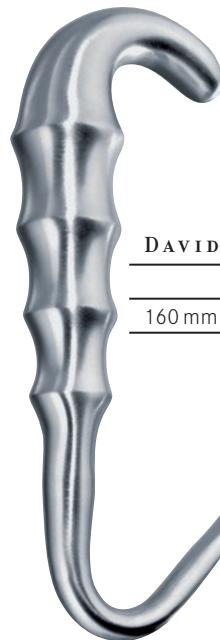

DAVIDSON

a = 75 mm – b = 50 mm

a = 75 mm – b = 90 mm

160 mm – 6 1/4"

tk 17176-01

tk 17176-02



1:2

Wundhaken
Retractors

Ecarteurs
Separadores
Divaricatori

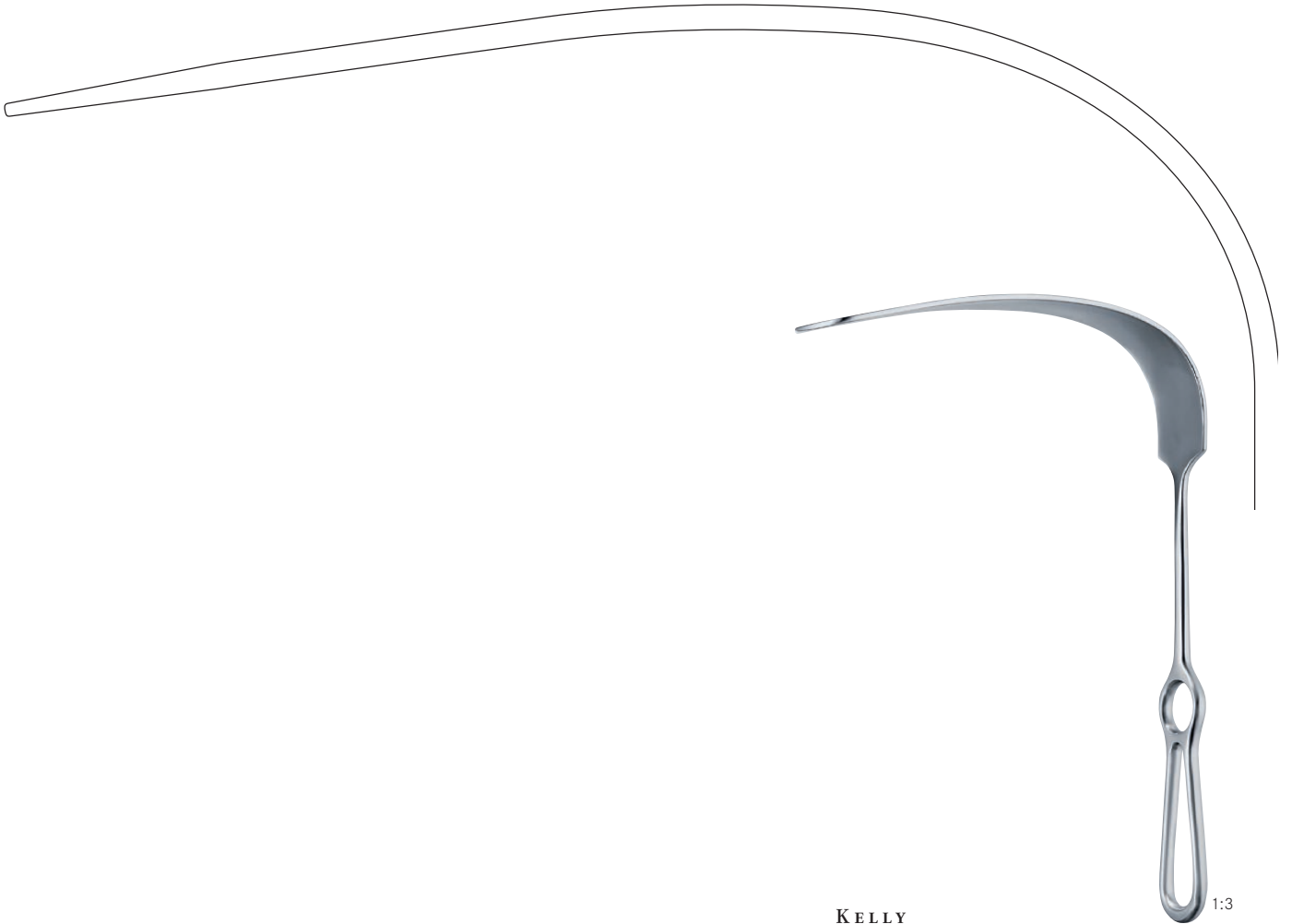

KELLY

1:3

	190 mm x 38 mm	190 mm x 57 mm
270 mm – 10 $\frac{3}{4}$ "	tk 17178-01	tk 17178-02

Wundhaken | Ecarteurs
 Retractors | Separadores
 Divaricatori



1:3

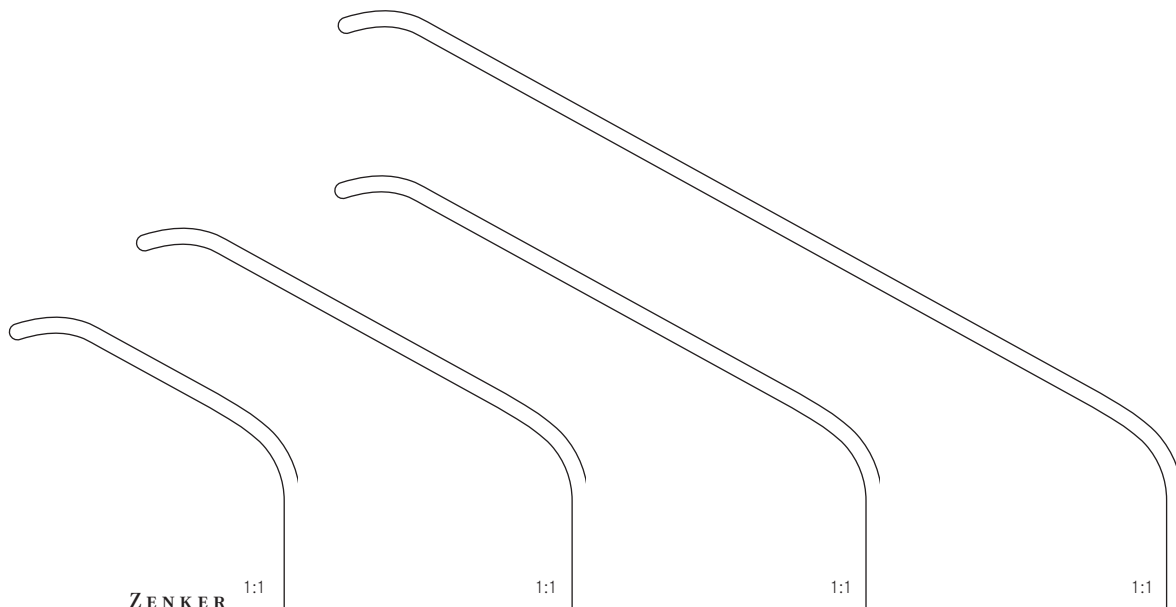

ZENKER 1:1	1:1	1:1	1:1
250 mm – 9¾"	260 mm – 10¼"	275 mm – 10¾"	290 mm – 11½"
35 mm x 8 mm	60 mm x 12 mm	75 mm x 12 mm	120 mm x 12 mm
tk 17179-01	tk 17179-02	tk 17179-03	tk 17179-04

Wundhaken
Retractors

Ecarteurs
Separadores
Divaricatori

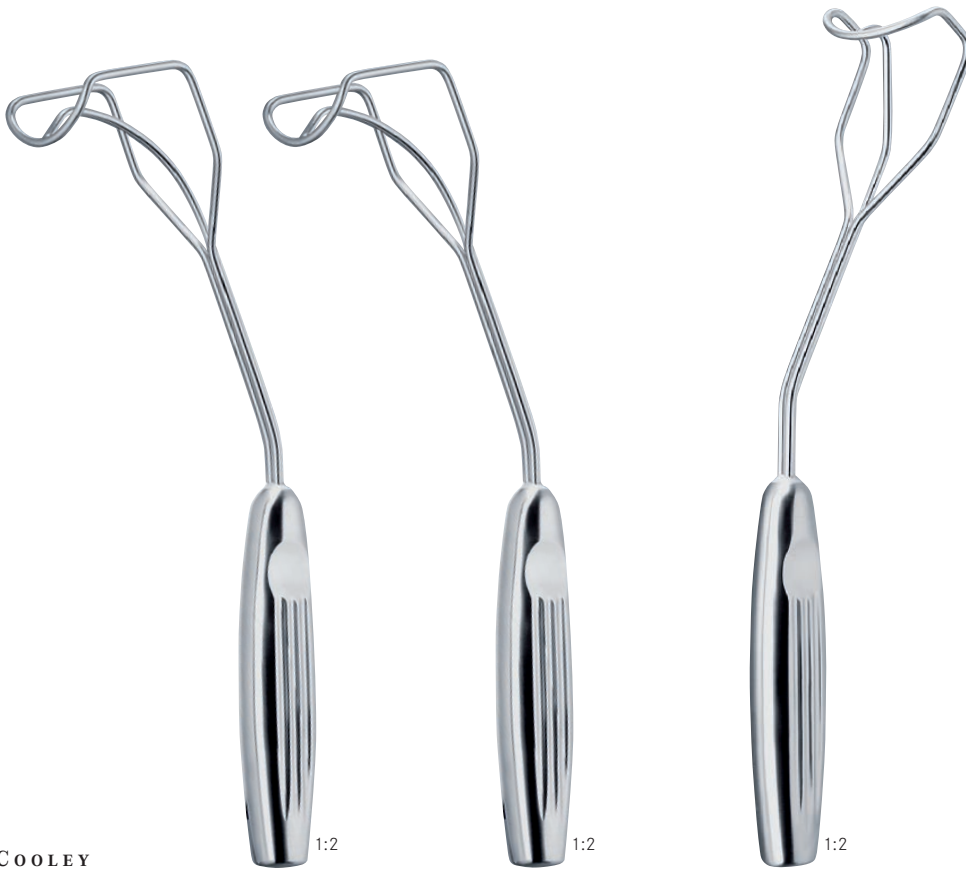

COOLEY

1:2	1:2	1:2
250 mm – 9¾"	250 mm – 9¾"	270 mm – 10½"
tk 17180-01	tk 17180-02	tk 17180-03

rechts
right
droite
derecha
destra

rechts, gerieft
right, serrated
droite, strié
derecha, estriada
destra, zigrinato

links
left
gauche
izquierda
sinistra

Wundhaken | Ecarteurs
 Retractors | Separadores
 Divaricatori

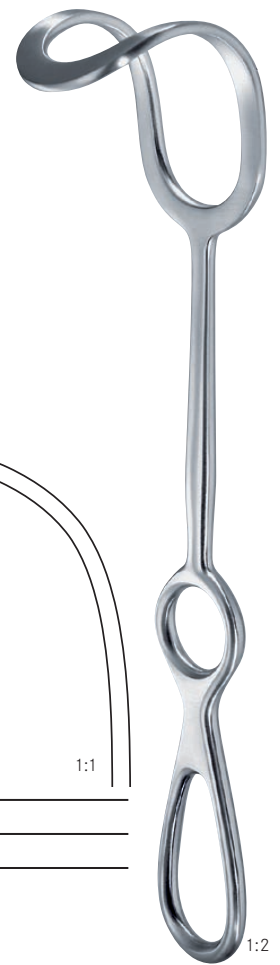
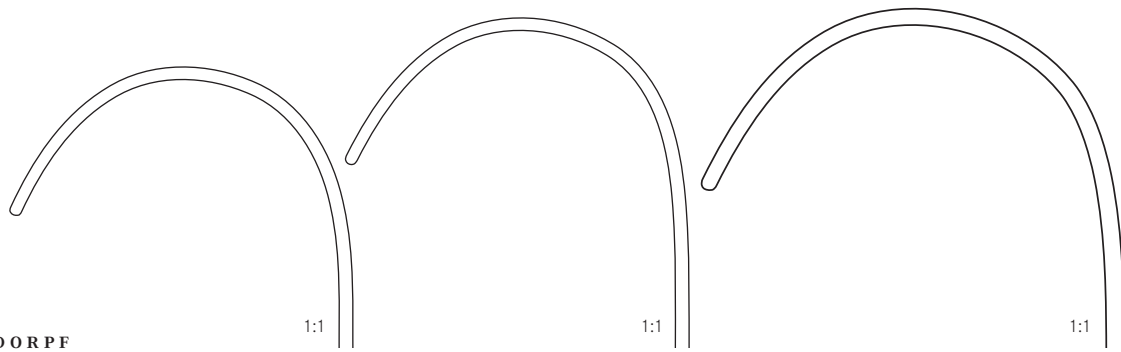

MIDDELDORPF

1:1

1:1

1:1

	45 mm x 45 mm	45 mm x 50 mm	55 mm x 70 mm
255 mm – 10"	tk 17181-01	tk 17181-02	tk 17181-03

Wundhaken
Retractors

Ecarteurs
Separadores
Divaricatori



DOYEN

250 mm – 9¾"

50 mm x 85 mm

tk 17184-25

1:2

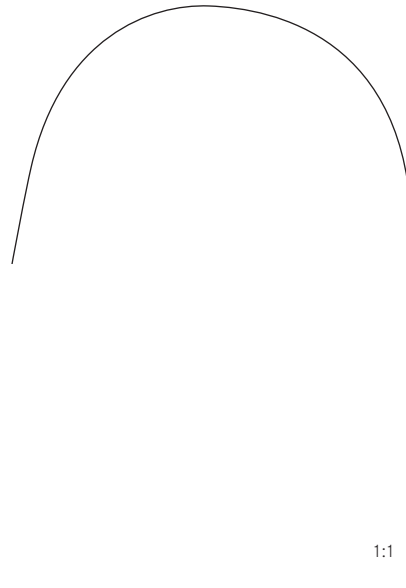

1:1

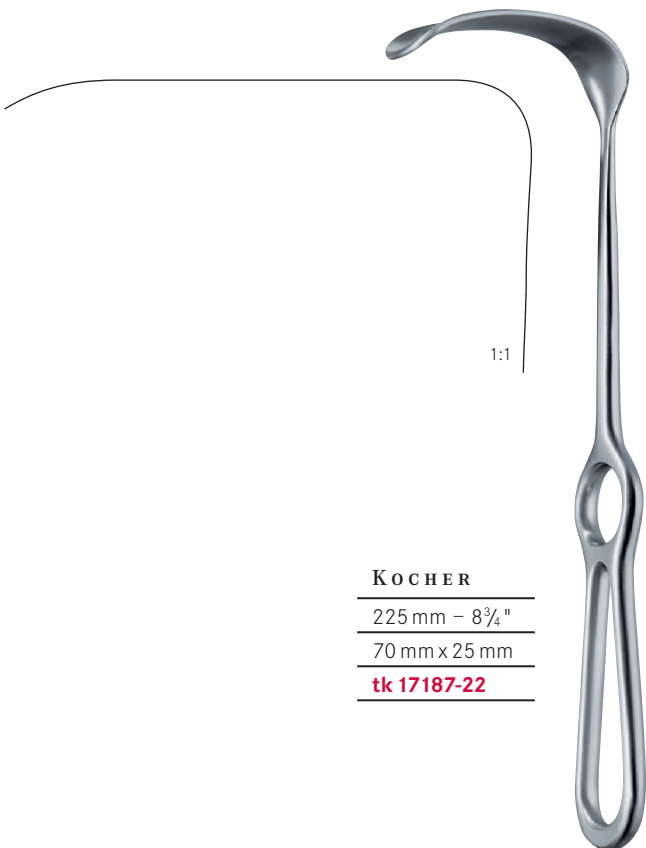

KOCHER

225 mm – 8¾"

70 mm x 25 mm

tk 17187-22

1:1

1:2

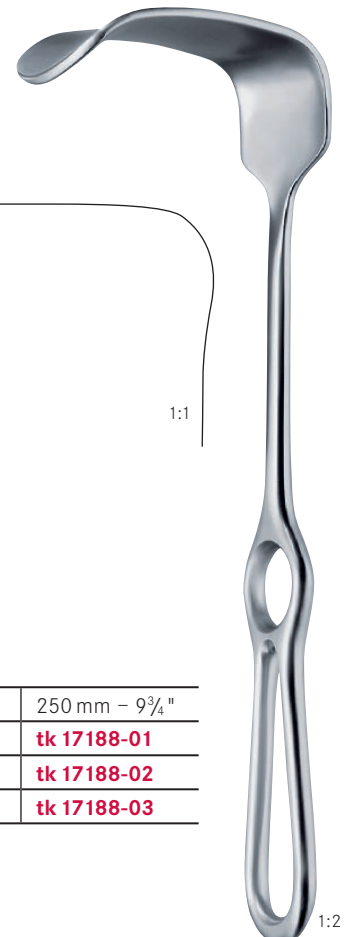

KOCHER

250 mm – 9¾"

80 mm x 45 mm **tk 17188-01**

80 mm x 55 mm **tk 17188-02**

80 mm x 65 mm **tk 17188-03**

1:1

1:2

Wundhaken
Retractors

Ecarteurs
Separadores
Divaricatori



TUFFIER

230 mm – 9"

64 mm x 60 mm

tk 17189-23

1:3



MARTIN

250 mm – 9³/₄"

105 mm x 27 mm

tk 17192-25

1:1

1:3



SAUERBRUCH

250 mm – 9³/₄"

125 mm x 37 mm

tk 17196-25

1:1

1:3

Wundhaken
Retractors

Ecarteurs
Separadores
Divaricatori

HEANEY	45 mm x 25 mm	73 mm x 28 mm
	270 mm – 10 $\frac{3}{4}$ "	tk 17193-01

82 mm x 28 mm
tk 17193-03

CORYLLOS	82 mm x 22 mm
	240 mm – 9 $\frac{1}{2}$ "

108 mm x 43 mm
tk 17194-02

115 mm x 65 mm
tk 17194-03



Wundhaken | Ecarteurs
 Retractors | Separadores
 Divaricatori



BRUNNER
 250 mm – 9¾"

1:2

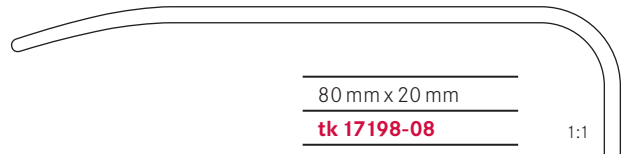

80 mm x 20 mm
tk 17198-08

1:1

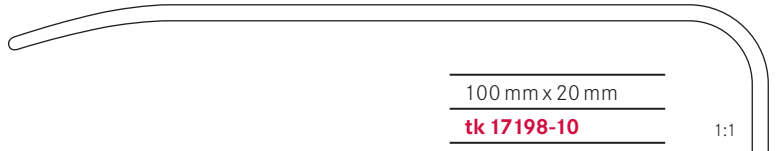

100 mm x 20 mm
tk 17198-10

1:1



120 mm x 25 mm
tk 17198-12

1:1



140 mm x 25 mm
tk 17198-14

1:1



160 mm x 30 mm
tk 17198-16

1:1

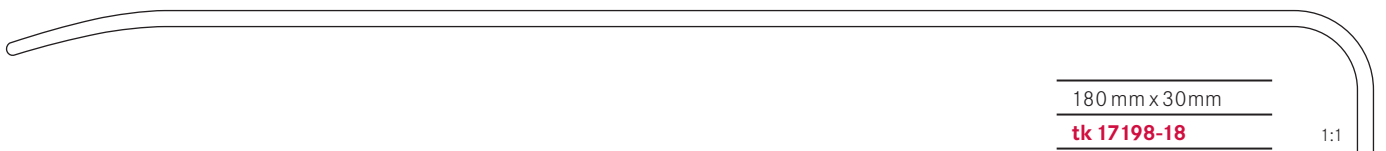

180 mm x 30 mm
tk 17198-18

1:1

Wundhaken
Retractors

Ecarteurs
Separadores
Divaricatori



Wundhaken | Ecarteurs
 Retractors | Separadores
 Divaricatori



GIL-VERNET



	x = 8 mm	x = 11 mm	x = 15 mm	x = 17 mm	x = 20 mm	x = 23 mm
240 mm – 9½"	tk 17203-08	tk 17203-11	tk 17203-15	tk 17203-17	tk 17203-20	tk 17203-23

biegsam
malleable
 malléable
maleable
 malleabile



ST. MARKS

290 mm – 11½"	325 mm – 12¾"	330 mm – 13"
130 mm x 60 mm	180 mm x 60 mm	180 mm x 60 mm
tk 17214-01	tk 17214-02	tk 17214-03

Wundhaken
Retractors

Ecarteurs
Separadores
Divaricatori

CUSHING

200 mm – 8"

tk 17204-20



1:2

KOERTE

280 mm – 11"

120 mm x 47 mm

tk 17212-28

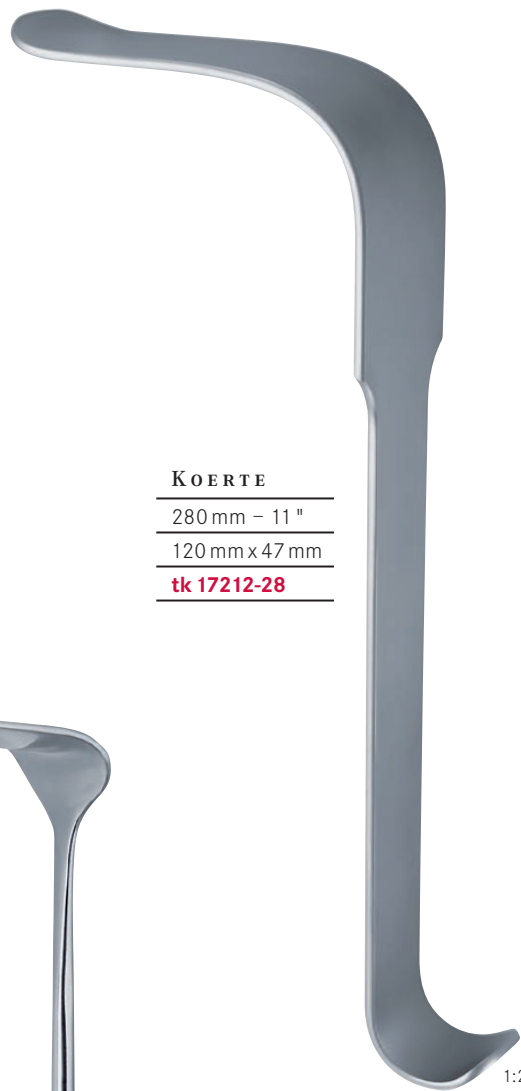

1:2



1:2

MORRIS

210 mm – 8 1/4"

50 mm x 55 mm

tk 17215-21



1:2

MORRIS

	70 mm x 40 mm	70 mm x 50 mm	70 mm x 65 mm
--	---------------	---------------	---------------

245 mm – 9 3/4"	tk 17900-40	tk 17900-50	tk 17900-65
-----------------	--------------------	--------------------	--------------------

Wundhaken
Retractors

Ecarteurs
Separadores
Divaricatori



DEAVER



	x = 25 mm	x = 38 mm	x = 50 mm
315 mm – 12½"	tk 17285-25	tk 17285-38	tk 17285-50

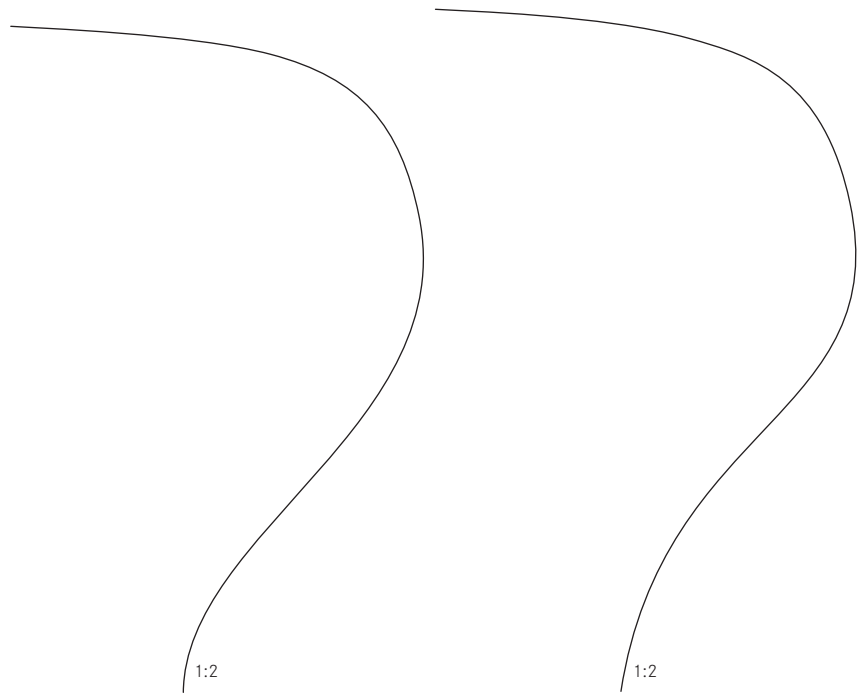

x = 75 mm	x = 100 mm
tk 17285-75	tk 17286-10

Wundhaken
Retractors

Ecarteurs
Separadores
Divaricatori



DEAVER

180 mm – 7"	215 mm – 8½"	230 mm – 9"
x = 19 mm	x = 22 mm	x = 25 mm
tk 17219-18	tk 17222-21	tk 17225-23

Wundhaken
Retractors

Ecarteurs
Separadores
Divaricatori



DEAVER

300 mm – 12"	330 mm – 13"	360 mm – 14¼"
x = 25 mm	x = 25 mm	x = 25 mm
tk 17225-30	tk 17225-33	tk 17225-36

Wundhaken
Retractors

Ecarteurs
Separadores
Divaricatori



DEAVER

1:2

1:2

1:2

300 mm – 12"	300 mm – 12"	300 mm – 12"
x = 38 mm	x = 50 mm	x = 75 mm
tk 17238-30	tk 17250-30	tk 17275-30

Wundhaken | Ecarteurs
 Retractors | Separadores
 Divaricatori

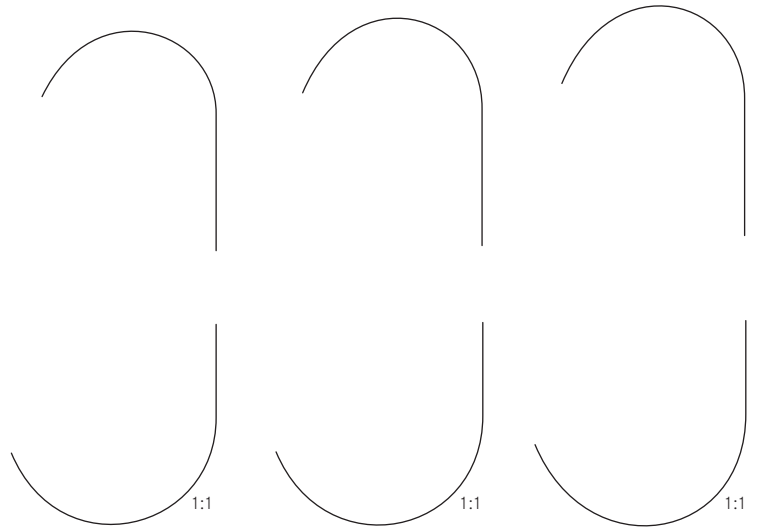

ROUX

	Fig. 1	Fig. 2	Fig. 3
	140 mm – 5½"	150 mm – 6"	170 mm – 6¾"
	24 mm x 20 mm	29 mm x 26 mm	33 mm x 29 mm
	30 mm x 28 mm	36 mm x 36 mm	38 mm x 43 mm
	tk 17301-14	tk 17302-15	tk 17303-17
tk 17300-00	x	x	x

Satz
 Set
 Jeu
 Juego
 Serie

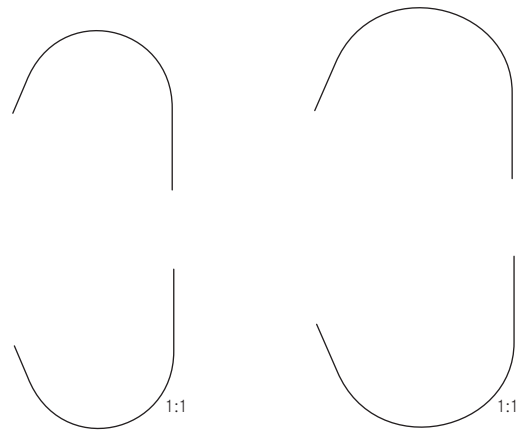

PARKER

	Fig. 1	Fig. 2
	135 mm – 5¼"	135 mm – 5¼"
	18 mm x 15 mm	22 mm x 15 mm
tk 17305-00	x	x

Satz
 Set
 Jeu
 Juego
 Serie

Wundhaken
Retractors

Ecarteurs
Separadores
Divaricatori

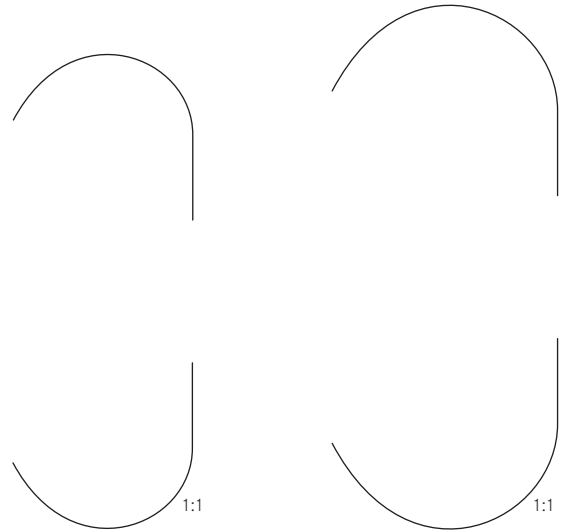

PARKER

180 mm – 7"	Fig. 1	Fig. 2
	26 mm x 25 mm	29 mm x 25 mm
	27 mm x 25 mm	27 mm x 25 mm
tk 17305-18	x	x

Satz
Set
Jeu
Juego
Serie



MINI-ROUX

145 mm – 5³/₄"
8 mm x 6 mm

tk 17306-01



BABY-ROUX

130 mm – 5"
17 mm x 16 mm
18 mm x 22 mm

tk 17306-02

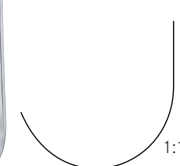

Wundhaken
Retractors

Ecarteurs
Separadores
Divaricatori

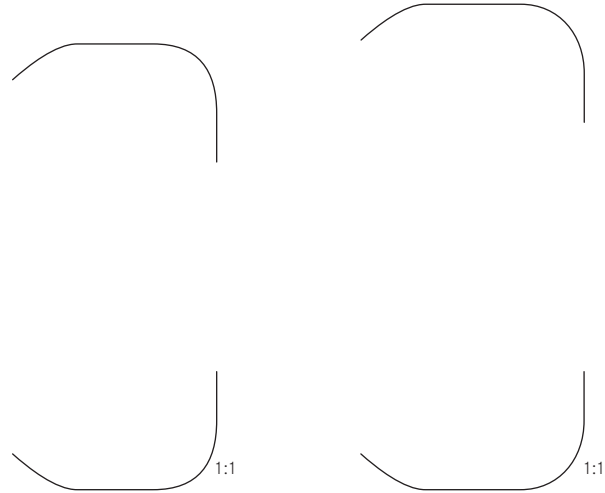

MAYO-COLLIN

150 mm – 6"	Fig. 1	Fig. 2
	25 mm x 18 mm	28 mm x 19 mm
	28 mm x 18 mm	32 mm x 19 mm
tk 17307-00	x	x

Satz
Set
Jeu
Juego
Serie

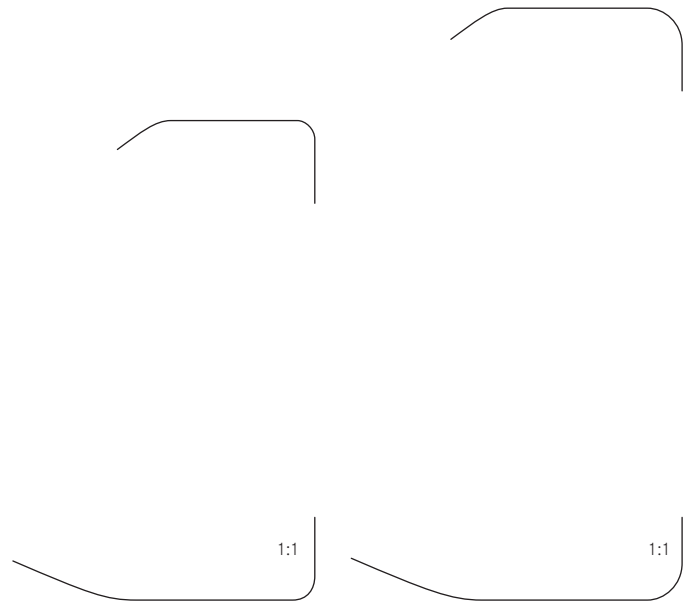

**PARKER-LANGENBECK
(US ARMY)**

210 mm – 8¼"	Fig. 1	Fig. 2
	21 mm x 24 mm	25 mm x 24 mm
	40 mm x 15 mm	45 mm x 15 mm
tk 17309-00	x	x

Satz
Set
Jeu
Juego
Serie

Wundhaken
Retractors

Ecarteurs
Separadores
Divaricatori

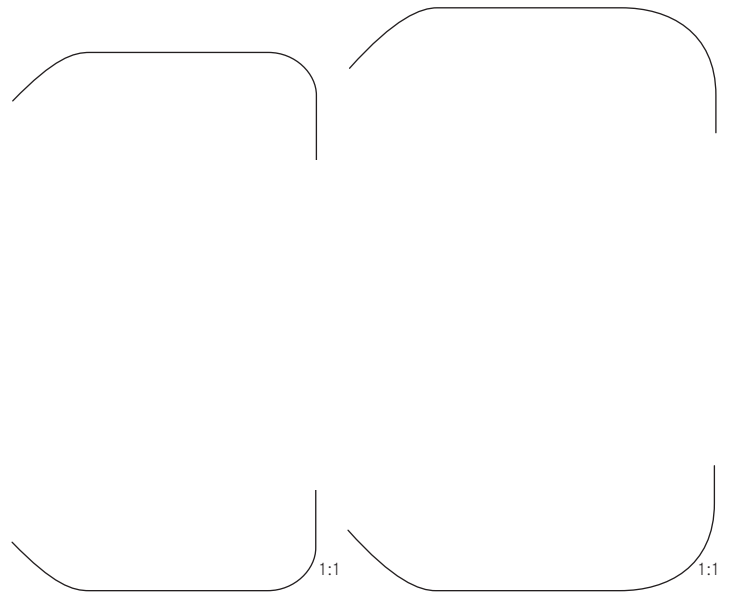

MATHIEU

200 mm – 8"	Fig. 1	Fig. 2
	42 mm x 13 mm	47 mm x 13 mm
	42 mm x 26 mm	46 mm x 26 mm
tk 17310-00	x	x

Satz

Set

Jeu

Juego

Serie

Wundhaken | Ecarteurs
 Retractors | Separadores
 Divaricatori



1:2

FARABEUF

120 mm – 4¾"	Fig. 1	Fig. 2
	26 mm x 10 mm	30 mm x 10 mm
	30 mm x 12 mm	34 mm x 12 mm
tk 17311-12	x	x

Satz
 Set
 Jeu
 Juego
 Serie

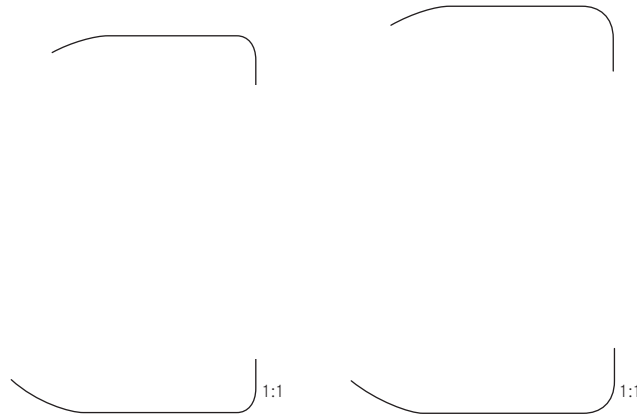

1:2

FARABEUF

150 mm – 6"	Fig. 1	Fig. 2
	23 mm x 16 mm	27 mm x 16 mm
	26 mm x 16 mm	30 mm x 16 mm
tk 17312-15	x	x

Satz
 Set
 Jeu
 Juego
 Serie

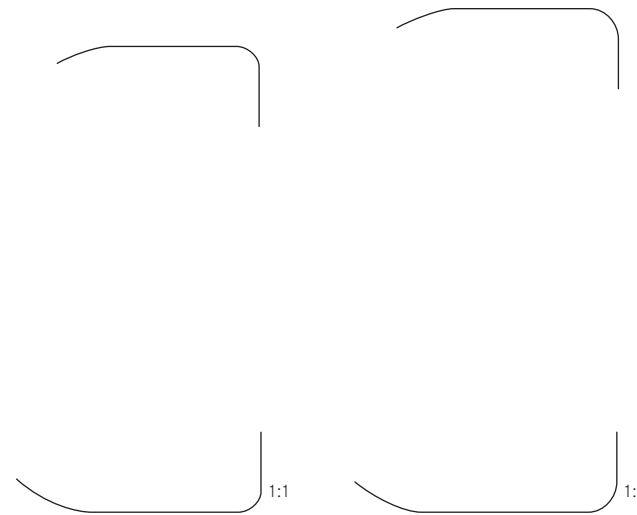

Wundsperrerr
Self-retaining retractors

Ecarteurs autostatiques
Separadores autoestáticos
Divaricatori autostatici



ALM

70 mm – 2¾"	tk 17330-07	tk 17330-17	tk 17331-07
100 mm – 4"	tk 17330-10	tk 17330-20	tk 17331-10

scharf <i>sharp</i>	halbscharf <i>semi sharp</i>	stumpf <i>blunt</i>
pointu <i>agudo</i>	semi pointu <i>semi agudo</i>	mousse <i>romo</i>
acuto	semi acuto	smusso



HOLTZHEIMER

100 mm – 4"	tk 17336-10	tk 17337-10
-------------	--------------------	--------------------

scharf <i>sharp</i>	stumpf <i>blunt</i>
pointu <i>agudo</i>	mousse <i>romo</i>
acuto	smusso



BOSE

70 mm – 2¾"
tk 17395-07



JANSEN

100 mm – 4"	tk 17480-01	tk 17480-02
110 mm – 4¼"		tk 17482-11

scharf <i>sharp</i>	stumpf <i>blunt</i>
pointu <i>agudo</i>	mousse <i>romo</i>
acuto	smusso

Wundsperrer
Self-retaining retractors

Ecarteurs autostatiques
Separadores autoestáticos
Divaricatori autostatici



CLOWARD-CONTOUR

140 mm – 5½"	tk 17406-01	tk 17406-02
3x4	scharf	3x4
	sharp	stumpf
		blunt
pointu		mousse
agudo		romo
acuto		smusso



WULLSTEIN

100 mm – 4"	tk 17408-01	tk 17408-02
3x3	scharf	3x3
	sharp	stumpf
		blunt
pointu		mousse
agudo		romo
acuto		smusso



WEITLANER-WULLSTEIN

130 mm – 5"	tk 17408-13	tk 17408-14
3x3	scharf	3x3
	sharp	stumpf
		blunt
pointu		mousse
agudo		romo
acuto		smusso



MILLIGAN

130 mm – 5"	tk 17409-13
3x3	scharf
	sharp
	stumpf
	blunt
	mousse
	romo
	smusso

Wundsperrer
Self-retaining retractors

Ecarteurs autostatiques
Separadores autoestáticos
Divaricatori autostatici



BELUCCI

110 mm – 4 1/4"	tk 17410-11	tk 17411-11
130 mm – 5"	tk 17410-13	tk 17411-13

1x2
links, stumpf
left, blunt
gauche, mousse
izquierda, romo
sinistra, smusso

1x2
rechts, stumpf
right, blunt
droit, mousse
derecha, romo
destra, smusso

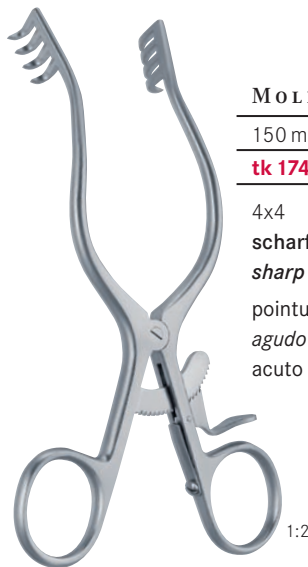

MOLLISON

150 mm – 6"

tk 17419-15

4x4
scharf
sharp
pointu
agudo
acuto

1:2

Wundsperrer
Self-retaining retractors

Ecarteurs autostatiques
Separadores autoestáticos
Divaricatori autostatici

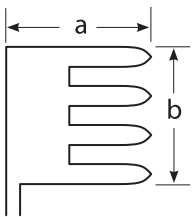

WEITLANER-LOKTITE

105 mm – 4¼"	a = 17 mm – b = 13 mm	tk 17400-10	tk 17400-20	tk 17401-10			
130 mm – 5"	a = 17 mm – b = 17 mm				tk 17402-13	tk 17402-23	tk 17403-13
165 mm – 6½"	a = 17 mm – b = 17 mm				tk 17402-16	tk 17402-26	tk 17403-16
200 mm – 8"	a = 20 mm – b = 19 mm				tk 17404-20	tk 17404-30	tk 17405-20
260 mm – 10¼"	a = 26 mm – b = 21 mm				tk 17404-26	tk 17404-36	tk 17405-26
	2 x 3	2 x 3	2 x 3	3 x 4	3 x 4	3 x 4	
	scharf	halbscharf	stumpf	scharf	halbscharf	stumpf	
	sharp	semi sharp	blunt	sharp	semi sharp	blunt	
	pointu	semi pointu	mousse	pointu	semi pointu	mousse	
	agudo	semi agudo	romo	agudo	semi agudo	romo	
	acuto	semi acuto	smusso	acuto	semi acuto	smusso	

Wundsperrer
Self-retaining retractors

Ecarteurs autostatiques
Separadores autoestáticos
Divaricatori autostatici



PLESTER

130 mm – 5"

tk 17450-13

tk 17451-13

2x2

stumpf

blunt

mousse

romo

smusso

2x2

scharf

sharp

pointu

agudo

acuto



PLESTER

110 mm – 4¼"

tk 17452-11

2x1

links, stumpf

left, blunt

gauche, mousse

izquierda, romo

sinistra, smusso



tk 17453-11

1x2

rechts, stumpf

right, blunt

droit, mousse

derecha, romo

destra, smusso

Wundsperrer
Self-retaining retractors

Ecarteurs autostatiques
Separadores autoestáticos
Divaricatori autostatici



NORFOLK
AND NORWICH

220 mm – 8¾"

tk 17413-22

4x5
stumpf
blunt
mousse
romo
smusso

1:2



TRAVERS

215 mm – 8½"

tk 17412-20

4x5
stumpf
blunt
mousse
romo
smusso

1:2



ANDERSON-ADSON

195 mm – 7¾"

tk 17417-19

tk 17418-19

4x4
scharf
sharp
pointu
agudo
acuto

4x4
stumpf
blunt
mousse
romo
smusso

1:2

Wundsperrer
Self-retaining retractors

Ecarteurs automatiques
Separadores autoestáticos
Divaricatori autostatici

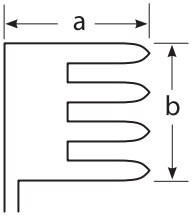

ADSON (CONE)

130 mm – 5"	a = 17 mm – b = 19 mm	tk 17423-13	tk 17424-13
160 mm – 6 ¹ / ₄ "	a = 17 mm – b = 19 mm	tk 17423-16	tk 17424-16
200 mm – 8"	a = 20 mm – b = 20 mm	tk 17423-20	tk 17424-20
260 mm – 10 ¹ / ₄ "	a = 26 mm – b = 21 mm	tk 17423-26	tk 17424-26

3x4
scharf
sharp
pointu
agudo
acuto

3x4
stumpf
blunt
mousse
romo
smusso



BECKMANN-EATON

320 mm – 12¹/₂"
tk 17425-32

7x7
scharf
sharp
pointu
agudo
acuto

1:2

Wundsperrer
Self-retaining retractors

Ecarteurs autostatiques
Separadores autoestáticos
Divaricatori autostatici

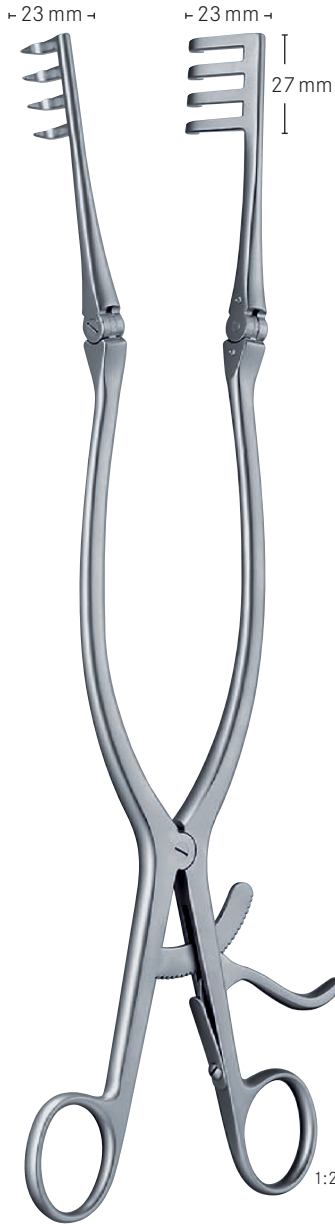

BECKMANN

310 mm – 12 1/4"	tk 17427-31	tk 17427-41	tk 17428-31
4x4	4x4	4x4	4x4
scharf sharp	halbscharf semi sharp	halbscharf semi sharp	stumpf blunt
pointu agudo	semi pointu semi agudo	semi pointu semi agudo	mousse romo
acuto	semi acuto	semi acuto	smusso

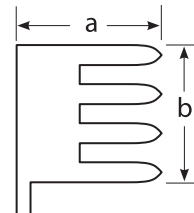

ADSON

		265 mm – 10 1/2"	265 mm – 10 1/2"
3x4	a = 24 mm – b = 24 mm	tk 17432-26	tk 17433-26
6x6	a = 40 mm – b = 40 mm	tk 17438-26	tk 17439-26
		scharf sharp	stumpf blunt
		pointu agudo	mousse romo
		acuto	smusso

Wundsperrer
Self-retaining retractors

Ecarteurs automatiques
Separadores autoestáticos
Divaricatori autostatici

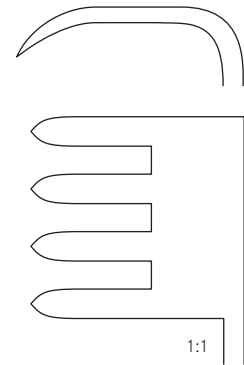
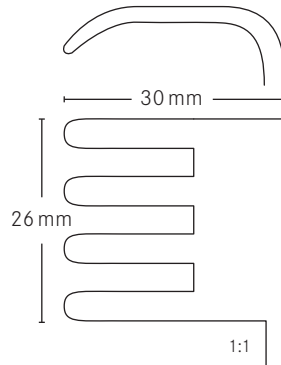
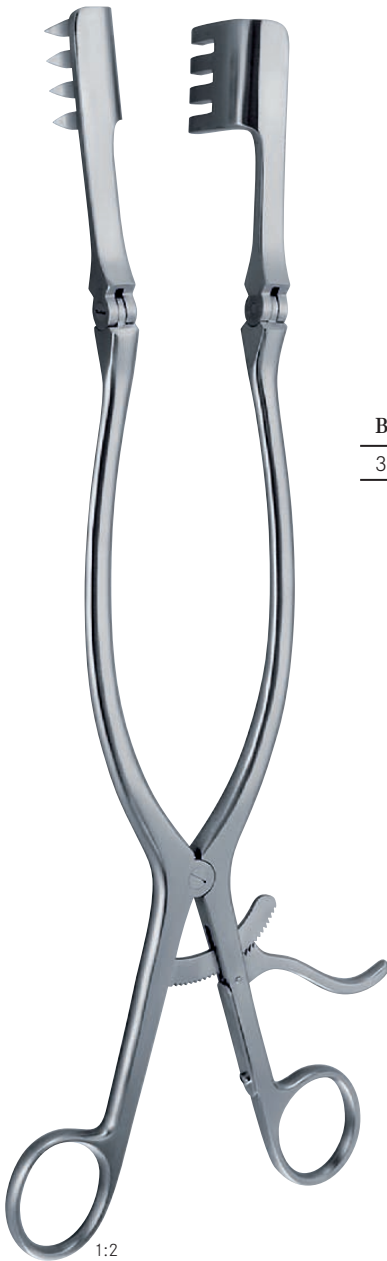

BECKMANN-ADSON

310 mm – 12 3/4"

tk 17441-00

tk 17441-01

stumpf
blunt

scharf
sharp

mousse
romo
smusso

pointu
agudo
acuto

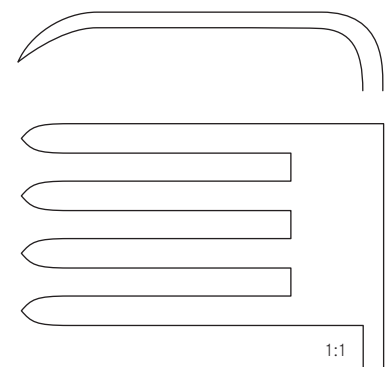
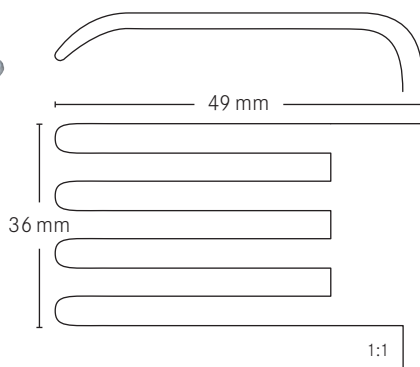

tk 17443-00

tk 17443-01

stumpf, mit tiefen Blättern
blunt, with deep blades

scharf, mit tiefen Blättern
sharp, with deep blades

mousse, avec lames profondes
romo, con palas profundas
smusso, con valve profonda

pointu, avec lames profondes
agudo, con palas profundas
acuto, con valve profonda

Wundsperrer
Self-retaining retractors

Ecarteurs autostatiques
Separadores autoestáticos
Divaricatori autostatici



GELPI-LOKTITE

90 mm – 3½"	tk 17470-09	
110 mm – 4¼"	tk 17470-11	
130 mm – 5"	tk 17470-13	
180 mm – 7"	tk 17470-18	tk 17471-18



MARKHAM-MEYERDING

180 mm – 7"	tk 17476-18	tk 17477-18
-------------	--------------------	--------------------

rechts
right
droit
derecha
destra

links
left
gauche
izquierda
sinistra



RIGBY

180 mm – 7"	tk 17490-18
-------------	--------------------

Wundsperrer
Self-retaining retractors

Ecarteurs autostatiques
Separadores autoestáticos
Divaricatori autostatici



HENLEY

165 mm – 6½"	tk 17414-01	tk 17414-02
3x4 scharf <i>sharp</i> pointu <i>agudo</i> acuto		3x4 stumpf <i>blunt</i> mousse <i>romo</i> smusso

komplett mit 3 Mittelvalven
complete with 3 center blades
complet avec 3 valves centrales
completa con 3 valvas centrales
completo con 3 valve centrali



19 mm x 16 mm	25 mm x 16 mm	32 mm x 16 mm
tk 17472-19	tk 17472-25	tk 17472-32

Mittelvalven
Center blades

Valves centrales
Valvas centrales
Valve centrali

Bauchdeckenhalter
Abdominal retractors

Ecarteurs abdominaux
Separadores abdominales
Divaricatori addominali

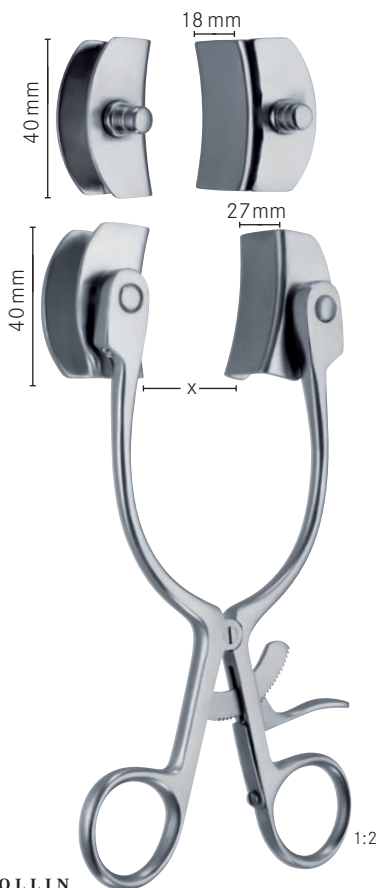

BABY-COLLIN

180 mm – 7"		
x = 80 mm		
tk 17500-00	40 mm x 18 mm	40 mm x 27 mm

komplett mit 2 Paar Valven
complete with 2 pairs of blades
complet avec 2 paires de valves
completo con 2 pares de valvas
completo con 2 paia di valve



COLLIN

220 mm – 8 3/4"		
x = 100 mm		
tk 17500-22		



COLLIN

225 mm – 8 3/4"		
x = 100 mm		
tk 17501-22	a = 38 mm – b = 60 mm	a = 38 mm – b = 55 mm
tk 17502-22	a = 38 mm – b = 80 mm	a = 50 mm – b = 75 mm
tk 17503-22	a = 37 mm – b = 98 mm	a = 53 mm – b = 76 mm

komplett mit
complete with
complet avec
completo con
completo con

Seitenvalven
Lateral blades
Valves latérales
Valvas laterales
Valve laterali

Mittelvalve
Center blade
Valve centrale
Valva centrale
Valva centrale

Bauchdeckenhalter
Abdominal retractors

Ecarteurs abdominaux
Separadores abdominales
Divaricatori addominali



COLLIN

260 mm – 10 1/4"		
x = 100 mm		
tk 17504-00	60 mm x 80 mm	60 mm x 75 mm

komplett mit	Seitenvalven	Mittelvalve
complete with	Lateral blades	Center blade
complet avec	Valves latérales	Valve centrale
completo con	Valvas laterales	Valva central
completo con	Valve laterali	Valva centrale

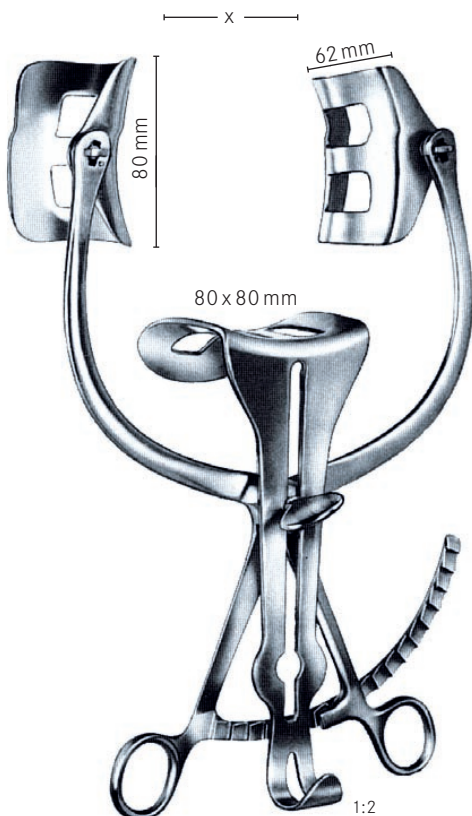

HOLZBACH

260 mm – 10 1/4"		
x = 100 mm		
tk 17507-00	62 mm x 80 mm	80 mm x 80 mm

komplett mit	Seitenvalven	Mittelvalve
complete with	Lateral blades	Center blade
complet avec	Valves latérales	Valve centrale
completo con	Valvas laterales	Valva centrale
completo con	Valve laterali	Valva centrale

Bauchdeckenhalter
Abdominal retractors

Ecarteurs abdominaux
Separadores abdominales
Divaricatori addominali

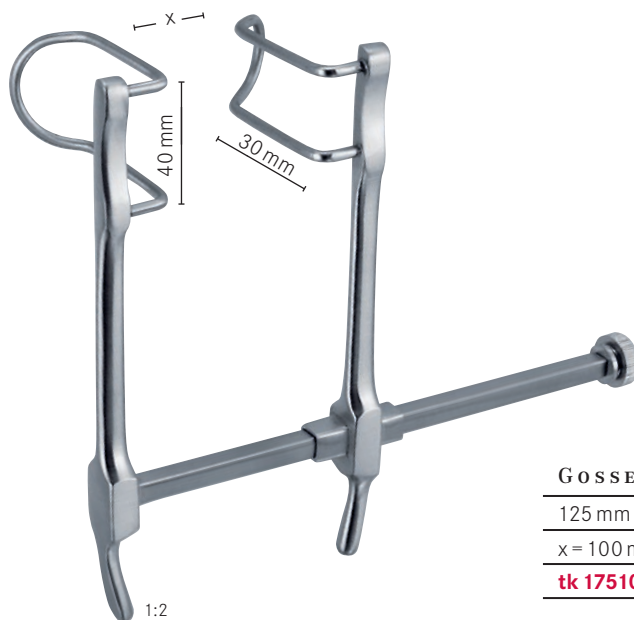

GOSSET

125 mm – 5"

x = 100 mm

tk 17510-90

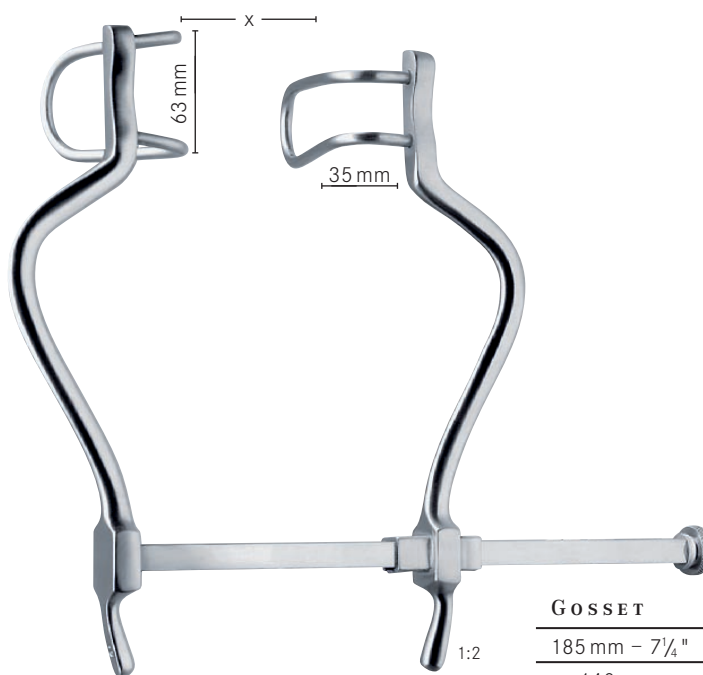

GOSSET

185 mm – 7 1/4"

x = 140 mm

tk 17520-14

Bauchdeckenhalter
Abdominal retractors

Ecarteurs abdominaux
Separadores abdominales
Divaricatori addominali

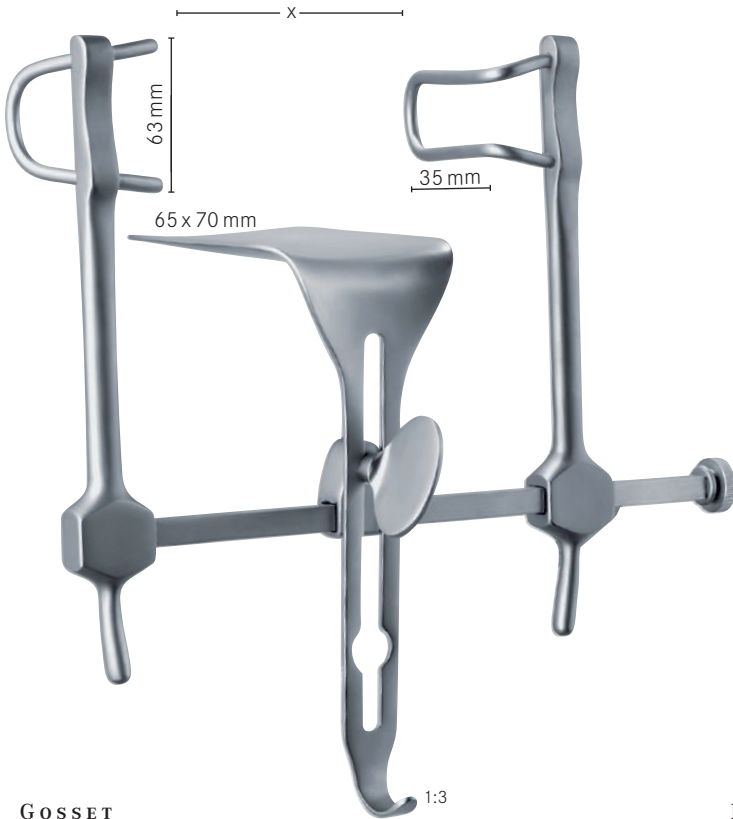

GOSSET

x = 160 mm

tk 17530-16

35 mm x 63 mm

65 mm x 70 mm

komplett mit
complete with
complet avec
completo con
completo con

Seitenvalven
Lateral blades
Valves latérales
Valvas laterales
Valve laterali

Mittelvalve
Center blade
Valve centrale
Valva centrale
Valva centrale



BALFOUR

x = 200 mm

tk 17540-20

35 mm x 100 mm

70 mm x 100 mm

komplett mit
complete with
complet avec
completo con
completo con

Seitenvalven
Lateral blades
Valves latérales
Valvas laterales
Valve laterali

Mittelvalve
Center blade
Valve centrale
Valva centrale
Valva centrale

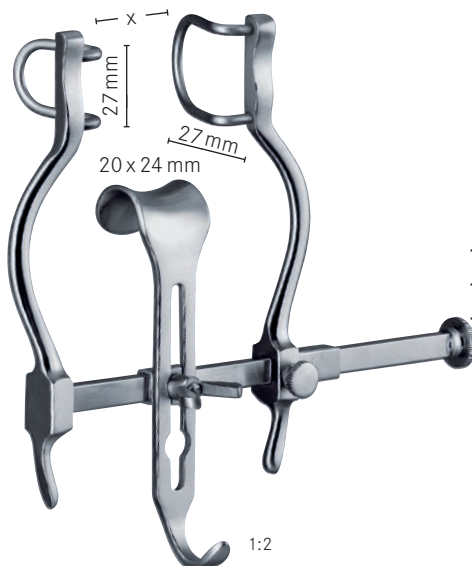

BALFOUR-BABY

x = 90 mm

tk 17550-09

27 mm x 27 mm

20 mm x 24 mm

komplett mit
complete with
complet avec
completo con
completo con

Seitenvalven
Lateral blades
Valves latérales
Valvas laterales
Valve laterali

Mittelvalve
Center blade
Valve centrale
Valva centrale
Valva centrale

Bauchdeckenhalter
Abdominal retractors

Ecarteurs abdominaux
Separadores abdominales
Divaricatori addominali



BALFOUR

x = 180 mm		
tk 17570-18	35 mm x 70 mm	45 mm x 80 mm
komplett mit <i>complete with</i>	Seitenvalven <i>Lateral blades</i>	Mittelvalve <i>Center blade</i>
complet avec	Valves latérales	Valve centrale
completo con	Valvas laterales	Valva centrale
completo con	Valve laterali	Valva centrale
x = 250 mm		
tk 17560-25	35 mm x 100 mm	70 mm x 85 mm
komplett mit <i>complete with</i>	Seitenvalven <i>Lateral blades</i>	Mittelvalve <i>Center blade</i>
complet avec	Valves latérales	Valve centrale
completo con	Valvas laterales	Valva centrale
completo con	Valve laterali	Valva centrale
45 mm x 80 mm	tk 17571-80	
70 mm x 85 mm	tk 17572-85	
80 mm x 90 mm	tk 17573-90	

Mittelvalven, allein
Center blades, only

Valves centrales, seul
Valvas centrales, sola
Valve centrali, solo

Bauchdeckenhalter
Abdominal retractors

Ecarteurs abdominaux
Separadores abdominales
Divaricatori addominali



RICARD

1:3



O'SULLIVAN-O'CONNOR

1:3

tk 17618-00	60 mm x 80 mm	55 mm x 70 mm
--------------------	---------------	---------------

komplett mit <i>complete with</i>	Seitenvalven <i>Lateral blades</i>	Mittelvalve <i>Center blade</i>
complet avec <i>completo con</i>	Valves latérales <i>Valvas laterales</i>	Valve centrale <i>Valva centrale</i>
completo con	Valve laterali	Valva centrale

tk 17610-00	45 mm x 90 mm	70 mm x 100 mm
--------------------	---------------	----------------

komplett mit <i>complete with</i>	Seitenvalven <i>Lateral blades</i>	Mittelvalven <i>Center blades</i>
complet avec <i>completo con</i>	Valves latérales <i>Valvas laterales</i>	Valves centrales <i>Valvas centrales</i>
completo con	Valve laterali	Valve centrali

tk 17620-00	70 mm x 85 mm	80 mm x 90 mm
--------------------	---------------	---------------

komplett mit <i>complete with</i>	Seitenvalven <i>Lateral blades</i>	Mittelvalve <i>Center blade</i>
complet avec <i>completo con</i>	Valves latérales <i>Valvas laterales</i>	Valve centrale <i>Valva centrale</i>
completo con	Valve laterali	Valva centrale

Bauchdeckenhalter
Abdominal retractors

Ecarteurs abdominaux
Separadores abdominales
Divaricatori addominali

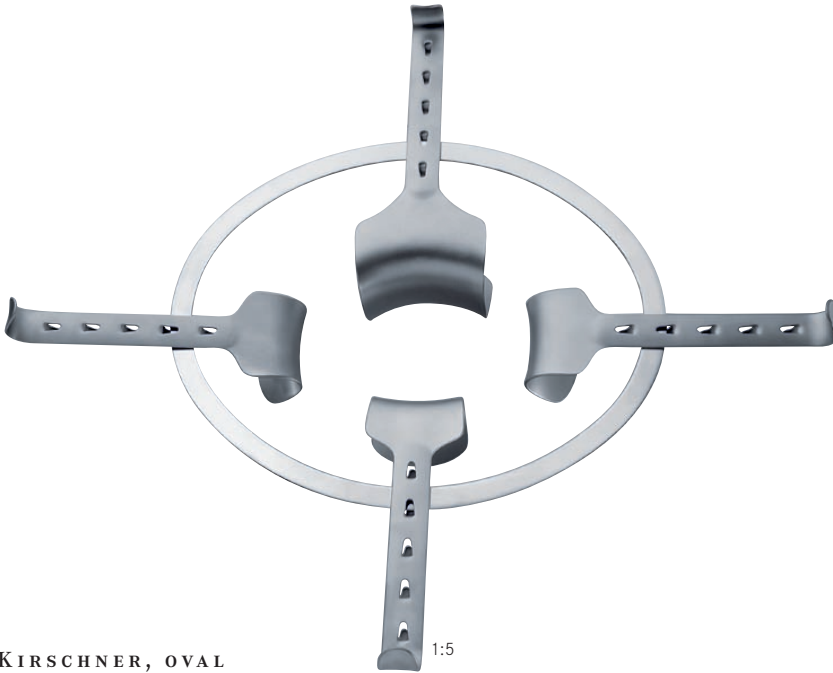

KIRSCHNER, OVAL

	240 mm x 300 mm	50 mm x 65 mm	80 mm x 90 mm	50 mm x 98 mm	35 mm x 105 mm
	tk 17625-01	tk 17640-02	tk 17640-06	tk 17640-07	tk 17640-08
1 Rahmen 1 Frame		3 Valven 3 Blades	1 Valve 1 Blade	1 Valve 1 Blade	1 Valve 1 Blade
1 Cadre 1 Cuadro		3 Valves 3 Valvas	1 Valve 1 Valva	1 Valve 1 Valva	1 Valve 1 Valva
1 Quadro		3 Valve	1 Valva	1 Valva	1 Valva
tk 17625-00	x	x	x	x	x

Satz
Set
Jeu
Juego
Serie

KIRSCHNER

	240 mm x 240 mm	40 mm x 55 mm	50 mm x 65 mm
	tk 17630-01	tk 17640-01	tk 17640-02
1 Rahmen, fest 1 Frame, rigid		2 Valven 2 Blades	2 Valven 2 Blades
1 Cadre, rigide 1 Cuadro, rigido		2 Valves 2 Valvas	2 Valves 2 Valvas
1 Quadro, rigido		2 Valve	2 Valve
tk 17630-00	x	x	x

Satz
Set
Jeu
Juego
Serie

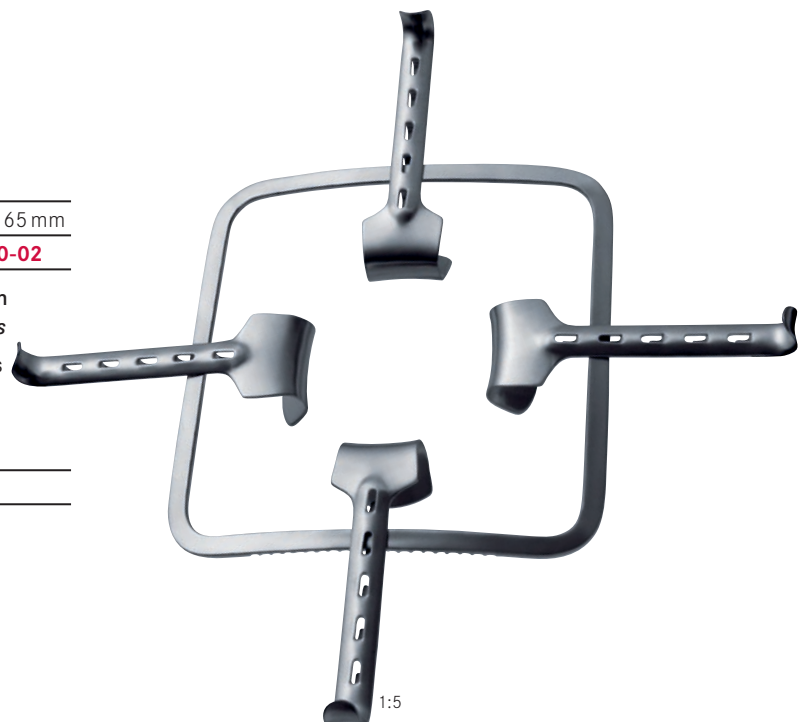

Bauchdeckenhalter
Abdominal retractors

Ecarteurs abdominaux
Separadores abdominales
Divaricatori addominali

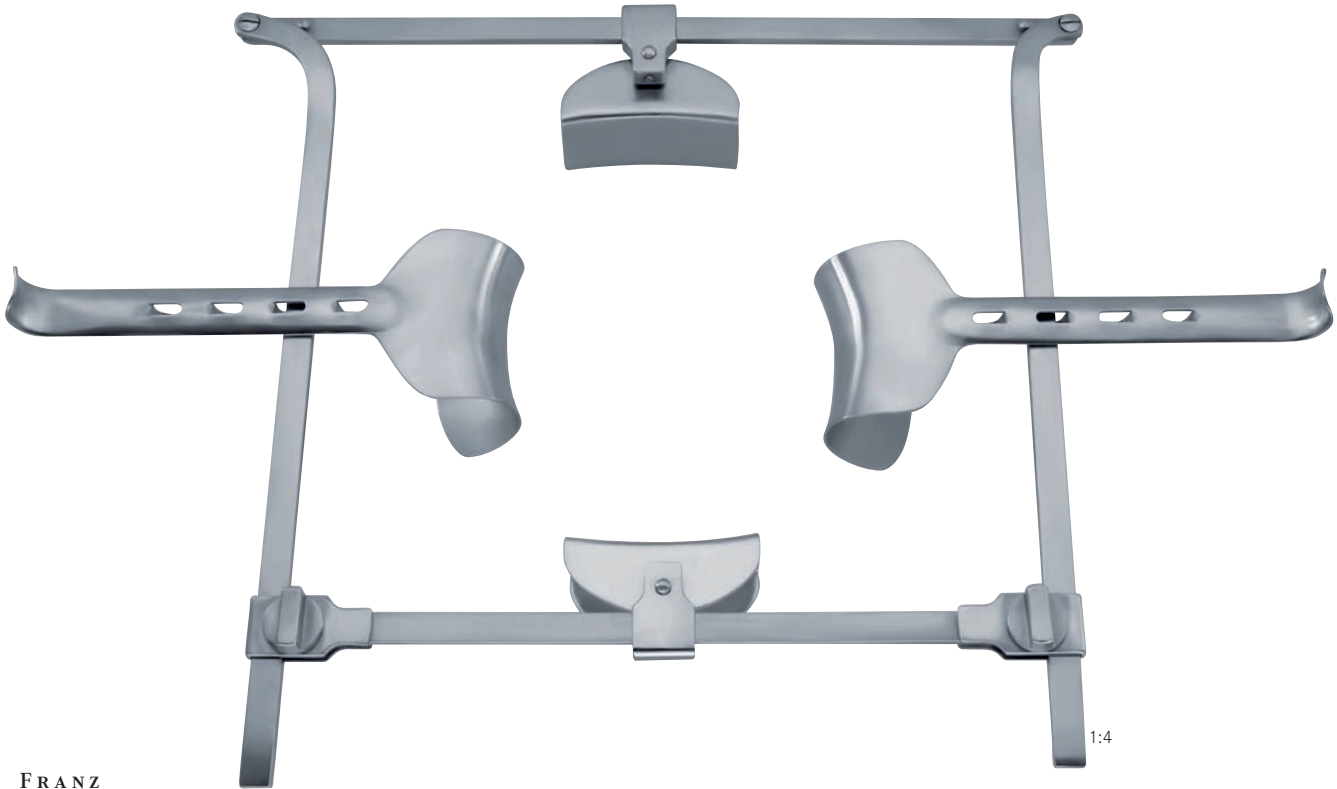

FRANZ

	300 mm x 300 mm	40 mm x 60 mm	45 mm x 80 mm	50 mm x 65 mm	60 mm x 85 mm
	tk 17645-01	tk 17632-06	tk 17632-08	tk 17640-02	tk 17640-03
	1 Rahmen, zusammenlegbar 1 Frame, foldable	2 Valven 2 Blades	2 Valven 2 Blades	2 Valven 2 Blades	2 Valven 2 Blades
	1 Cadre pliant 1 Cuadro plegable	2 Valves 2 Valvas	2 Valves 2 Valvas	2 Valves 2 Valvas	2 Valves 2 Valvas
	1 Quadro piegabile	2 Valve	2 Valve	2 Valve	2 Valve
tk 17645-00	x	x		x	
tk 17650-00	x	x	x	x	x

Satz
Set
Jeu
Juego
Serie



Rahmen zusammenlegbar
Frame foldable
Cadre pliant
Cuadro plegable
Quadro piegabile

Bauchdeckenhalter
Abdominal retractors

Ecarteurs abdominaux
Separadores abdominales
Divaricatori addominali



Valven für Kirschner- und Franz-Rahmen
Blades for Kirschner- and Franz-frames

Valves pour cadres Kirschner et Franz
Valvas para los cuadros de Kirschner y Franz
Valve per i quadri di Kirschner e Franz



40 mm x 60 mm

45 mm x 80 mm

40 mm x 55 mm

50 mm x 65 mm

tk 17632-06

tk 17632-08

tk 17640-01

tk 17640-02



60 mm x 85 mm

80 mm x 90 mm

50 mm x 98 mm

35 mm x 105 mm

tk 17640-03

tk 17640-06

tk 17640-07

tk 17640-08

Bauchspatel
Abdominal spatulas

Spatulas abdominales
Espátulas abdominales
Spatole addominali



	30 mm	40 mm	50 mm
330 mm – 13"	tk 17882-30	tk 17882-40	tk 17882-50

biegsam
malleable
malléable
maleable
flessibile



MARTIN

200 mm – 8"	200 mm – 8"	250 mm – 9¾"
12 mm	17 mm	25 mm
tk 17884-12	tk 17884-17	tk 17884-25

weich
soft
souple
flexible
morbido

	6,5 mm	9,5 mm	13 mm	16 mm	19 mm	25 mm
200 mm – 8"	tk 17880-06	tk 17880-09	tk 17880-13	tk 17880-16	tk 17880-19	tk 17880-25

biegsam, sehr weich
malleable, very soft
malléable, très souple
maleable, muy flexible
flessibile, molto morbido

Bauchspatel
Abdominal spatulas

Spatulas abdominales
Espátulas abdominales
Spatole addominali



HABERER

200 mm – 8 "	280 mm – 11 "	300 mm – 12 "
17 mm / 25 mm	25 mm / 30 mm	37 mm / 45 mm
tk 17886-25	tk 17886-30	tk 17886-45

biegsam
malleable
malléable
maleable
flessibile



REVERDIN

280 mm – 11 "
46 mm x 60 mm
tk 17887-28

1:2

Wundspreizer
Retractors

Ecarteurs
Separadores
Divaricatori



1:2

O'SULLIVAN-O'CONNOR



1:2

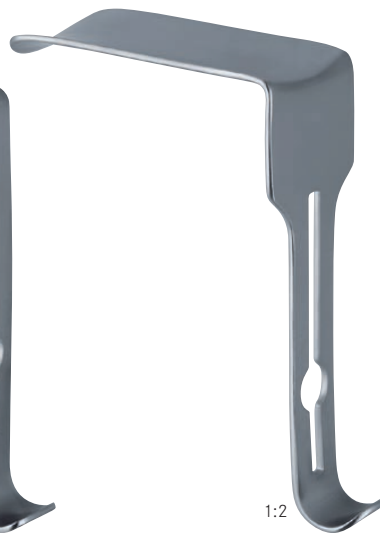

1:2



1:2

	Fig. 1	Fig. 2	Fig. 3
	45 mm x 17 mm	90 mm x 37 mm	90 mm x 45 mm
	tk 34138-03	tk 34138-04	tk 34138-05
tk 34138-00	x	x	x

komplett
complete
complet
completo
completo



1:2

FRIEDMANN

100 mm – 4"

tk 34139-10

Laminektomiesperrer
Laminectomy retractors

Ecarteurs pour laminectomie
Separadores para laminectomia
Divaricatori per laminectomia



CLOWARD

160 mm – 6 1/4"

tk 17783-00

komplett mit je 2 Valven Fig. 1 - Fig. 5
complete with 2 blades ea. Fig. 1 - Fig. 5
complet avec 2 valves chacune Fig. 1 - Fig. 5
completo con 2 valvas de cada Fig. 1 - Fig. 5
completo con 2 valve Fig. 1 - Fig. 5

tk 17782-00

Sperrer ohne Valven
Retractor without blades
Ecarteur sans valves
Separador sin valvas
Divaricatore senza valve



250 mm – 9 3/4"

tk 17781-00

komplett mit je 2 Valven Fig. 1 - Fig. 5
complete with 2 blades ea. Fig. 1 - Fig. 5
complet avec 2 valves chacune Fig. 1 - Fig. 5
completo con 2 valvas de cada Fig. 1 - Fig. 5
completo con 2 valve Fig. 1 - Fig. 5

tk 17780-00

Sperrer ohne Valven
Retractor without blades
Ecarteur sans valves
Separador sin valvas
Divaricatore senza valve



Fig. 1	x = 60 mm	tk 17783-01
Fig. 2	x = 55 mm	tk 17783-02
Fig. 3	x = 50 mm	tk 17783-03
Fig. 4	x = 45 mm	tk 17783-04
Fig. 5	x = 40 mm	tk 17783-05

stumpf
blunt

mousse
roma
smussa



Fig. 1	x = 60 mm	tk 17781-01
Fig. 2	x = 55 mm	tk 17781-02
Fig. 3	x = 50 mm	tk 17781-03
Fig. 4	x = 45 mm	tk 17781-04
Fig. 5	x = 40 mm	tk 17781-05

gezahnt
toothed

dentelée
dentada
dentata

Laminektomiesperrer
Laminectomy retractors

Ecarteurs pour laminectomie
Separadores para laminectomia
Divaricatori per laminectomia

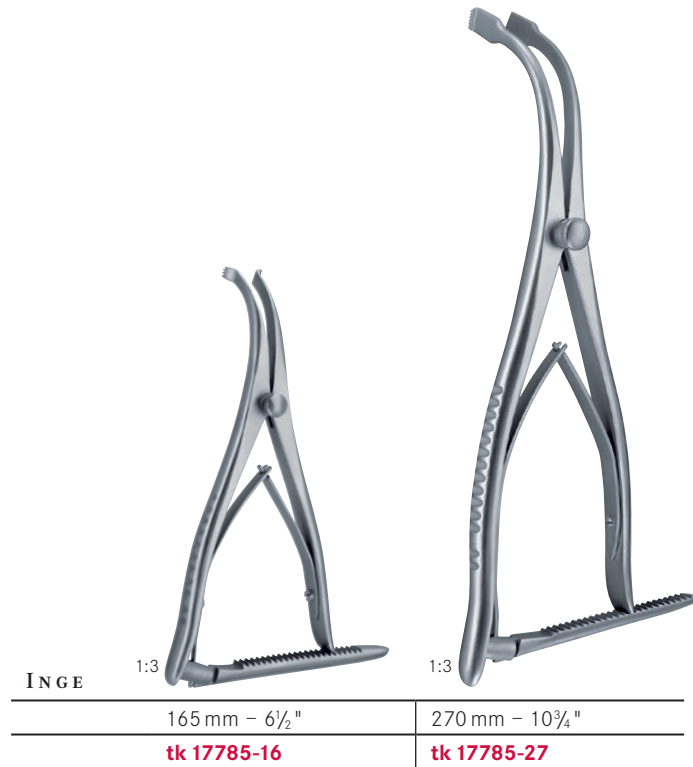

Laminektomiesperrer
Laminectomy retractors

Ecarteurs pour laminectomie
Separadores para laminectomia
Divaricatori per laminectomia

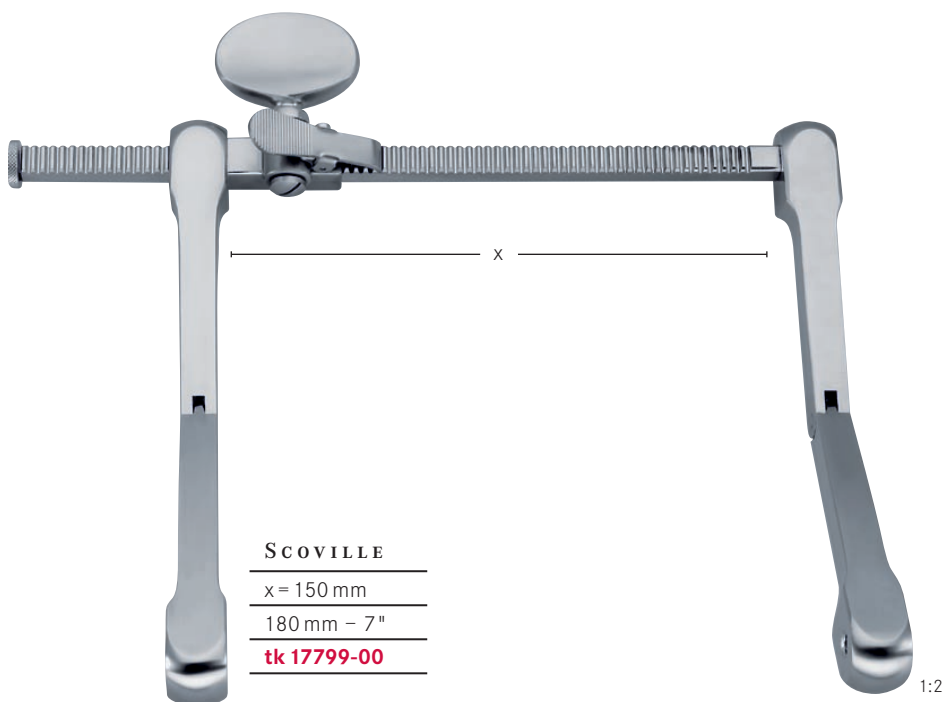
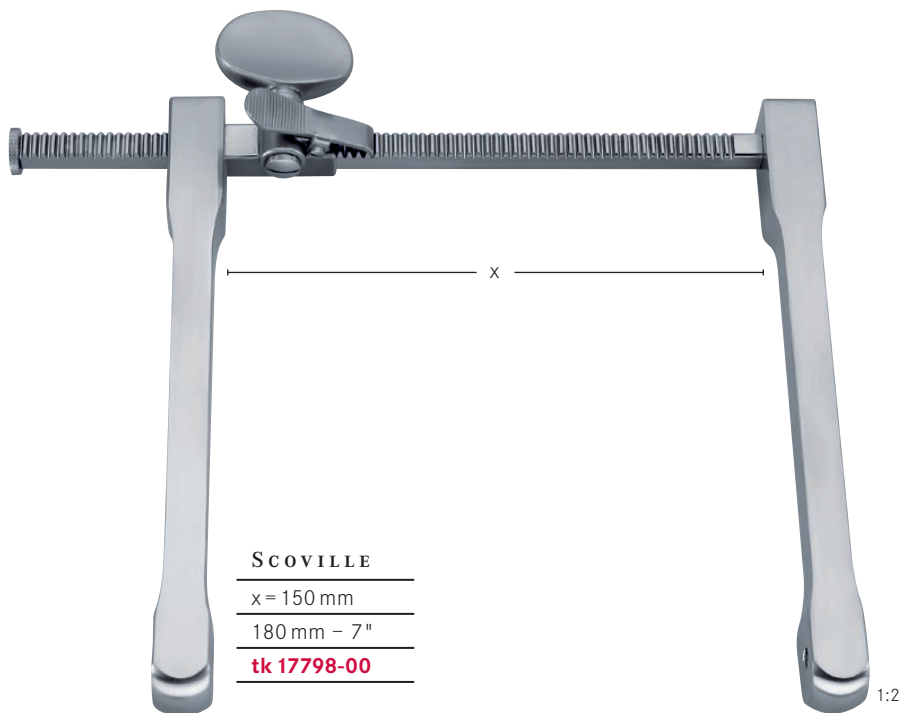

Laminektomiesperrer
Laminectomy retractors

Ecarteurs pour laminectomie
Separadores para laminectomia
Divaricatori per laminectomia

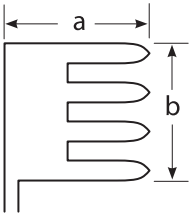

SCOVILLE

50 mm – 2"	tk 17800-05	tk 17801-05
70 mm – 2¾"	tk 17800-07	tk 17801-07

stumpf	spitz
blunt	sharp
mousse	pointu
roma	aguda
smussa	acuta



TAYLOR

a = 48 mm – b = 50 mm – 2" x 2"	tk 17802-05
a = 63 mm – b = 50 mm – 2½" x 2"	tk 17802-06
a = 64 mm – b = 64 mm – 3¼" x 2¼"	tk 17802-08



SCOVILLE

a = 40 mm – b = 37 mm – 1½" x 1½"	tk 17803-04
a = 65 mm – b = 44 mm – 2½" x 1¾"	tk 17803-06



TAYLOR

a = 100 mm – b = 42 mm – 4" x 1⅞"	tk 17804-02
-----------------------------------	--------------------

Laminektomiesperrer
Laminectomy retractors

Ecarteurs pour laminectomie
Separadores para laminectomia
Divaricatori per laminectomia

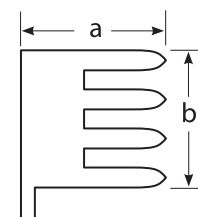

MEYERDING

a = 57 mm - b = 25 mm - 2 1/4" x 1"	tk 17805-01
a = 76 mm - b = 25 mm - 3" x 1"	tk 17805-02
a = 88 mm - b = 51 mm - 3 1/2" x 2"	tk 17805-03



SCOVILLE

a = 57 mm - b = 25 mm - 2 1/4" x 1"	tk 17806-01
a = 57 mm - b = 38 mm - 2 1/4" x 1 1/2"	tk 17806-02
a = 64 mm - b = 50 mm - 2 1/2" x 2"	tk 17806-03
a = 75 mm - b = 25 mm - 3" x 1"	tk 17806-04



EPSTEIN

a = 56 mm - b = 25 mm - 2 1/4" x 1"	tk 17807-01
-------------------------------------	--------------------



HIBBS

a = 50 mm - b = 20 mm - 2" x 3/4"	tk 17808-01
a = 50 mm - b = 25 mm - 2" x 1"	tk 17808-02
a = 50 mm - b = 50 mm - 2" x 2"	tk 17808-03
a = 63 mm - b = 25 mm - 2 1/2" x 1"	tk 17808-04
a = 63 mm - b = 37 mm - 2 1/2" x 1 1/2"	tk 17808-05
a = 76 mm - b = 25 mm - 3" x 1"	tk 17808-06
a = 76 mm - b = 38 mm - 3" x 1 1/2"	tk 17808-07
a = 76 mm - b = 50 mm - 3" x 2"	tk 17808-08
a = 76 mm - b = 63 mm - 3" x 2 1/2"	tk 17808-09
a = 90 mm - b = 25 mm - 3 1/2" x 1"	tk 17808-10
a = 90 mm - b = 37 mm - 3 1/2" x 1 1/2"	tk 17808-11
a = 102 mm - b = 25 mm - 4" x 1"	tk 17808-12
a = 102 mm - b = 50 mm - 4" x 2"	tk 17808-13

Laminektomiesperrer
Laminectomy retractors

Ecarteurs pour laminectomie
Separadores para laminectomia
Divaricatori per laminectomia

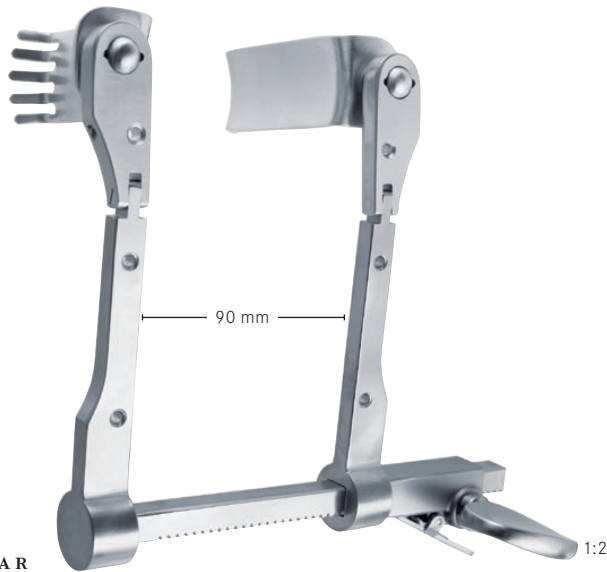

CASPAR

tk 17829-00

komplett mit 5 medial Valven tk 17826-01 - tk 17826-05
und mit 5 lateral Valven tk 17827-01 - tk 17827-05
complete with 5 medial blades tk 17826-01 - tk 17826-05
and with 5 lateral blades tk 17827-01 - tk 17827-05
complet avec 5 valves médianes tk 17826-01 - tk 17826-05
et avec 5 valves latérales tk 17827-01 - tk 17827-05
completo con 5 valvas mediales tk 17826-01 - tk 17826-05
y con 5 valvas laterales tk 17827-01 - tk 17827-05
completo con 5 valve mediali tk 17826-01 - tk 17826-05
e con 5 valve laterali tk 17827-01 - tk 17827-05



1:2

tk 17823-00

komplett mit 5 Valven tk 17824-01 - tk 17824-05
complete with 5 blades tk 17824-01 - tk 17824-05
complet avec 5 valves tk 17824-01 - tk 17824-05
completo con 5 valvas tk 17824-01 - tk 17824-05
completo con 5 valve tk 17824-01 - tk 17824-05

tk 17829-01

Sperrer ohne Valven
Retractor without blades
Ecarteur sans valves
Separador sin valvas
Divaricatore senza valve

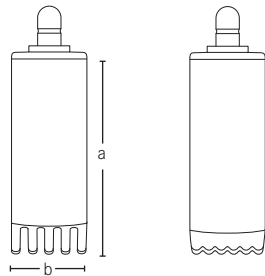

CASPAR

	medial	lateral
a = 40 mm - b = 23 mm	tk 17826-01	tk 17827-01
a = 45 mm - b = 23 mm	tk 17826-02	tk 17827-02
a = 50 mm - b = 23 mm	tk 17826-03	tk 17827-03
a = 55 mm - b = 23 mm	tk 17826-04	tk 17827-04
a = 60 mm - b = 23 mm	tk 17826-05	tk 17827-05

tk 17823-01

Sperrer ohne Valven
Retractor without blades
Ecarteur sans valves
Separador sin valvas
Divaricatore senza valve

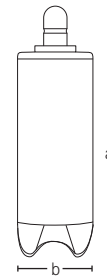

CASPAR

a = 45 mm - b = 23 mm	tk 17824-01
a = 50 mm - b = 23 mm	tk 17824-02
a = 55 mm - b = 23 mm	tk 17824-03
a = 60 mm - b = 23 mm	tk 17824-04
a = 65 mm - b = 23 mm	tk 17824-05

stumpf
blunt
mousse
roma
smussa

Laminektomiesperrer
Laminectomy retractors

Ecarteurs pour laminectomie
Separadores para laminectomia
Divaricatori per laminectomia



CASPAR

tk 17828-00

komplett mit 6 Valven tk 17831-01 und tk 17832-02 - 06
complete with 6 blades tk 17831-01 and tk 17832-02 - 06
complet avec 6 valves tk 17831-01 et tk 17832-02 - 06
completo con 6 valvas tk 17831-01 y tk 17832-02 - 06
completo con 6 valve tk 17831-01 e tk 17832-02 - 06



tk 17830-00

komplett mit 5 Valven tk 17824-01 - tk 17824-05
complete with 5 blades tk 17824-01 - tk 17824-05
complet avec 5 valves tk 17824-01 - tk 17824-05
completo con 5 valvas tk 17824-01 - tk 17824-05
completo con 5 valve tk 17824-01 - tk 17824-05

tk 17828-10

Sperrer ohne Valven
Retractor without blades
Ecarteur sans valves
Separador sin valvas
Divaricatore senza valve

tk 17823-01

Sperrer allein, mit Schlüssel
Retractor only, with key
Ecarteur seul avec clé
Separador solo con llave
Divaricatore solo con chiave

tk 17830-02

Schlüssel
Key
Clé
Llave
Chiave



Laminektomiesperrer
Laminectomy retractors

Ecarteurs pour laminectomie
Separadores para laminectomia
Divaricatori per laminectomia



CASPAR

38 mm	58 mm
tk 17831-01	tk 17831-02



a = 35 mm – b = 22 mm	tk 17832-01
a = 40 mm – b = 22 mm	tk 17832-02
a = 45 mm – b = 22 mm	tk 17832-03
a = 50 mm – b = 22 mm	tk 17832-04
a = 55 mm – b = 22 mm	tk 17832-05
a = 60 mm – b = 22 mm	tk 17832-06
a = 65 mm – b = 22 mm	tk 17832-07
a = 70 mm – b = 22 mm	tk 17832-08

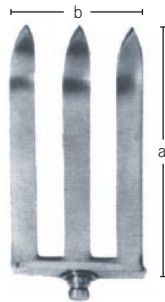

a = 35 mm – b = 37 mm	tk 17833-01
a = 40 mm – b = 37 mm	tk 17833-02
a = 45 mm – b = 37 mm	tk 17833-03
a = 50 mm – b = 37 mm	tk 17833-04
a = 55 mm – b = 37 mm	tk 17833-05
a = 60 mm – b = 37 mm	tk 17833-06
a = 65 mm – b = 37 mm	tk 17833-07
a = 70 mm – b = 37 mm	tk 17833-08

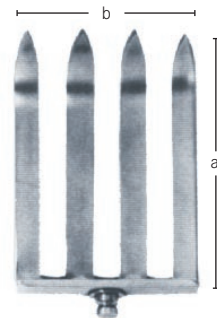

a = 35 mm – b = 52 mm	tk 17834-01
a = 40 mm – b = 52 mm	tk 17834-02
a = 45 mm – b = 52 mm	tk 17834-03
a = 50 mm – b = 52 mm	tk 17834-04
a = 55 mm – b = 52 mm	tk 17834-05
a = 60 mm – b = 52 mm	tk 17834-06
a = 65 mm – b = 52 mm	tk 17834-07
a = 70 mm – b = 52 mm	tk 17834-08

Wundspreizer zur Mikrodiskektomie
Retractors for Micro-Lumbar Discectomy

Retracteurs pour la micro discectomie lumbaire
Retractor para la micro discectomia lumbar
 Divaricatore per la micro dissezione lombare

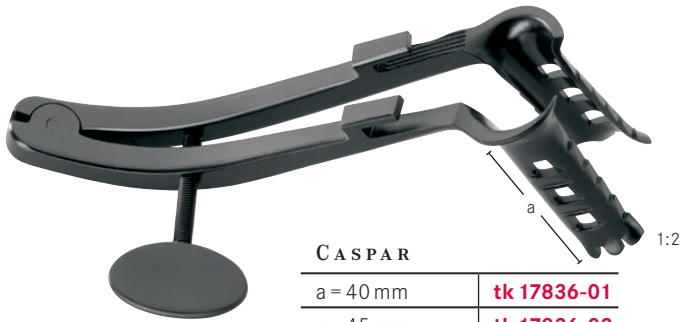

CASPAR	
a = 40 mm	tk 17836-01
a = 45 mm	tk 17836-02
a = 50 mm	tk 17836-03
a = 55 mm	tk 17836-04
a = 60 mm	tk 17836-05
a = 65 mm	tk 17836-06
a = 75 mm	tk 17836-07
a = 85 mm	tk 17836-08



Mit schwarzer Oberfläche
With black finish
 Avec finition noir
Con color negro
 Con superficie nera



CASPAR	
tk 17837-00	



CASPAR		
a = 35 mm	tk 17837-01	
a = 40 mm	tk 17837-02	tk 17838-01
a = 45 mm	tk 17837-03	tk 17838-02
a = 50 mm	tk 17837-04	tk 17838-03
a = 55 mm	tk 17837-05	tk 17838-04
a = 60 mm	tk 17837-06	tk 17838-05
a = 65 mm	tk 17837-07	tk 17838-06
a = 70 mm		tk 17838-07
a = 75 mm	tk 17837-08	
a = 85 mm	tk 17837-09	



Mit schwarzer Oberfläche
With black finish
 Avec finition noir
Con color negro
 Con superficie nera

Hypophysenspekulum
Speculum for hypophysectomy

Spéculum pour hypophysectomie
Especulo para hypophysectomia
Specolo per ipofisectomia



Mit schwarzer Oberfläche
With black finish
Avec finition noir
Con color negro
Con superficie nera



x = 70 mm	tk 24927-70
x = 90 mm	tk 24927-90
x = 110 mm	tk 24928-10

Spekulum für trans-sphenoidale Hypophysectomie
Speculum for trans-sphenoidal hypophysectomy
Spéculum pour hypophysectomie trans-sphenoidable
Especulo para hypophysectomia trans-sphenoidal
Specolo per ipofisectomia trans-sfenoidale