



SAPPHIRE™
Enhanced Needle Grip Surface



A



B



C

Standard TC (N)
(0.5)



D



Geister-Vascular

For a secure but gentle grip of needles and sutures without damage in General Surgery, Cardiovascular Surgery, Plastic Surgery, Urology

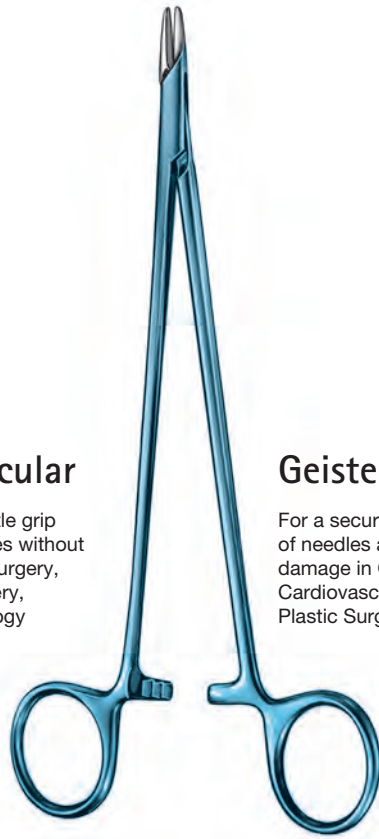

Geister-Vascular

For a secure but gentle grip of needles and sutures without damage in General Surgery, Cardiovascular Surgery, Plastic Surgery, Urology

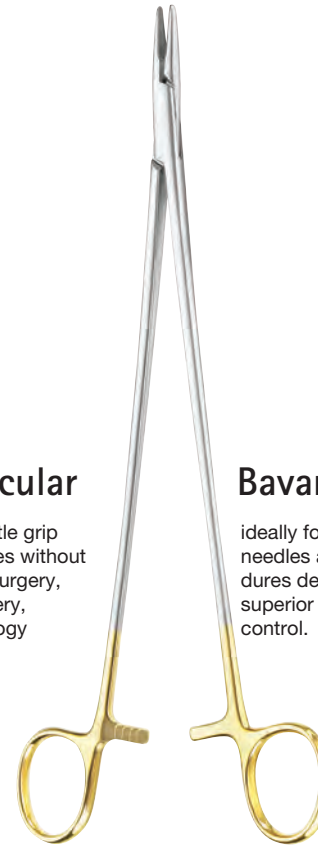

Bavaria TC

ideally for larger needles and procedures demanding superior needle control.

Geister-Vascular

Length	Fig.	Art.-No.
13 cm/5"	A	24-0496
16.5 cm/6¼"	A	24-0498
18 cm/7"	A	24-0500
19 cm/7½"	A	24-0502
23 cm/9"	A	24-0504
25.5 cm/10"	A	24-0506

Geister-Vascular-Ryder

Length	Fig.	Art.-No.
13 cm/5"	B	24-0497
16.5 cm/6¼"	B	24-0499
18 cm/7"	B	24-0501
19 cm/7½"	B	24-0503
23 cm/9"	B	24-0505
25.5 cm/10"	B	24-0507

Geister-Vascular Titanium

Length	Fig.	Art.-No.
12.5 cm/4½"	C	24-0530
14.5 cm/5½"	C	24-0532
17.5 cm/6½"	C	24-0534
19.5 cm/7½"	C	24-0536
22.5 cm/8½"	C	24-0538

Bavaria TC

Length	Fig.	Art.-No.
23 cm/9"	D	24-0510
26 cm/10¼"	D	24-0512



Derf



24-8101
13 cm/5"



Webster



24-8111
13 cm/5"



Baumgartner



24-8115
13 cm/5"



Crile-Wood



24-8131
15 cm/6"

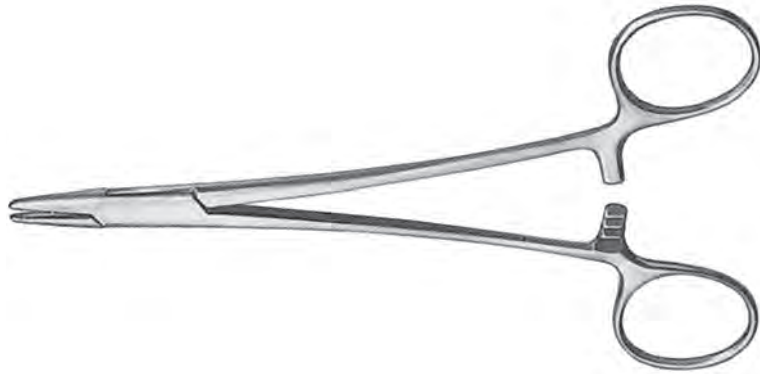

Mayo-Hegar

Mathieu



24-8142
16 cm/6¼"



24-8143
18 cm/7"



24-8144
20 cm/8"



24-8145
24 cm/9½"



24-8146
26 cm/10¼"



24-8170
14 cm/5½"



24-8171
17 cm/6½"



24-8172
20 cm/8"







Mayo-Hegar



Crile-Wood

2.0 mm

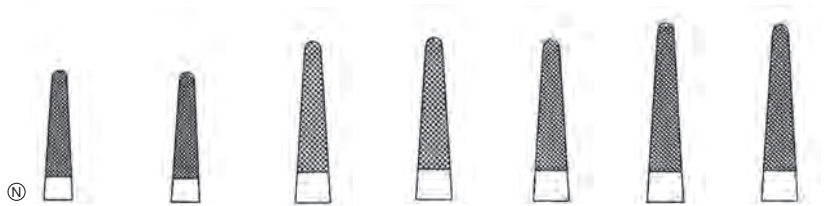

- 24-0129 14 cm
- 24-0130 16 cm [24-0130.TI](#)
- 24-0131 18 cm [24-0131.TI](#)
- 24-0132 20 cm [24-0132.TI](#)
- 24-0133 24 cm
- 24-0134 26 cm
- 24-0135 30 cm

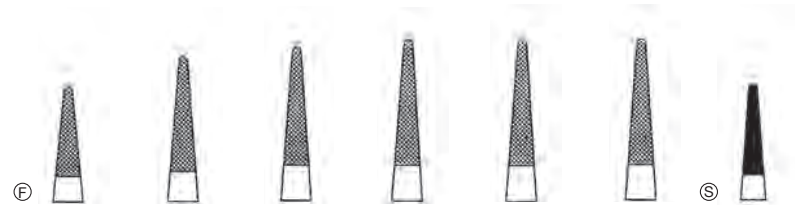

- 24-0311 18 cm
- 24-0312 20 cm
- 24-0313 23 cm
- 24-0314 26 cm
- 24-0315 30 cm
- 24-0308 15 cm/6''



Baby Crile-Wood
1.7 mm



24-0307
15 cm/6''
[24-0307.TI](#)

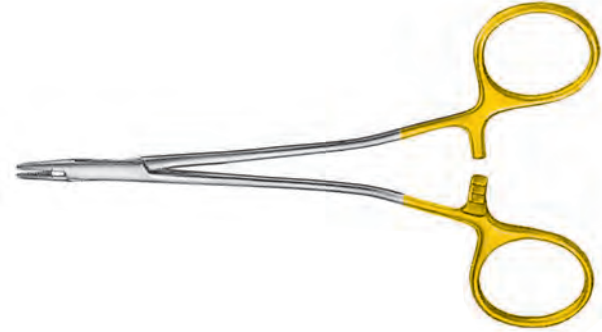

Swedish
1.7 mm



24-0490
14 cm/5½''

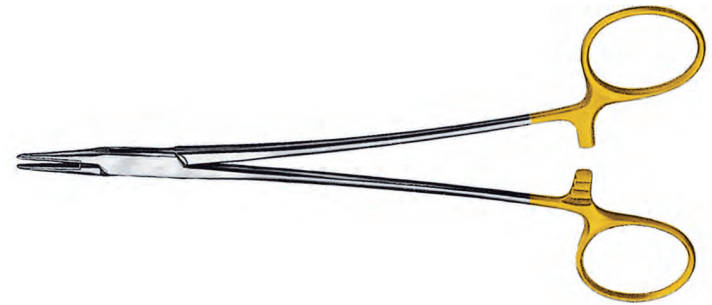
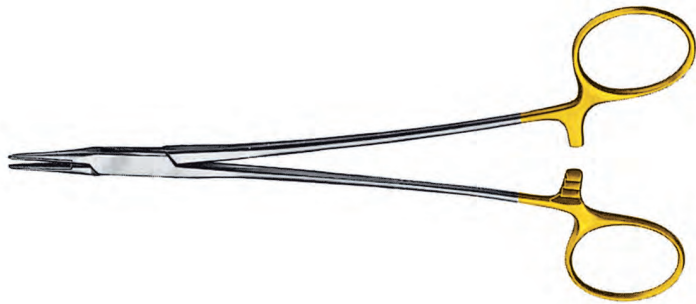

DeBakey
1.5 mm

Micro-Vascular
1.2 mm
(DeBakey delicate)

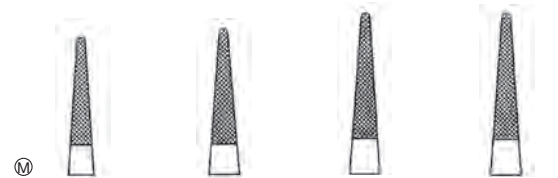



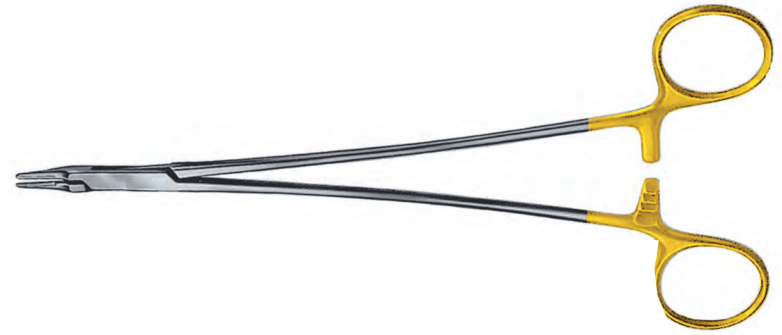
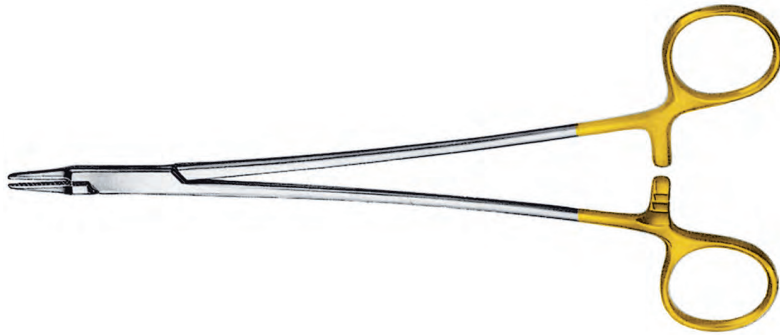

- Ⓕ 24-0360 18 cm [24-0360.TI](#)
- 24-0361 20 cm [24-0361.TI](#)
- 24-0362 23 cm
- 24-0363 26 cm [24-0363.TI](#)
- 24-0364 30 cm

- Ⓜ 24-0350 14 cm
- 24-0351 18 cm
- 24-0352 20 cm
- 24-0353 23 cm







Intracardiac

1.9 mm

- Ⓕ
- | | | | |
|--|--|--|--|
|  |  |  |  |
| 24-0322
18 cm/7" | 24-0323
20 cm/8" | 24-0324
23 cm/9" | 24-0325
26 cm/10¼" |

Mini-Ryder

1.2 mm

- Ⓜ
- | | | | | |
|--|--|--|--|--|
|  |  |  |  |  |
| 24-0410
13 cm
24-0410.TI | 24-0412
15 cm
24-0412.TI | 24-0413
18 cm
24-0413.TI | 24-0414
20 cm
24-0414.TI | 24-0415
23 cm |

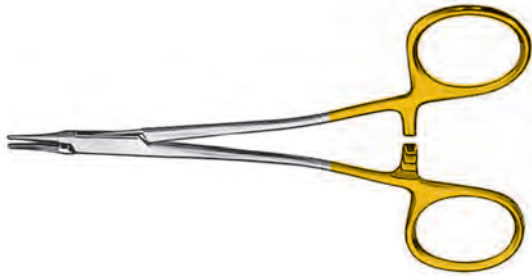

Eufrate-Pasqué

1.2 mm



Lemmon

1.6 mm

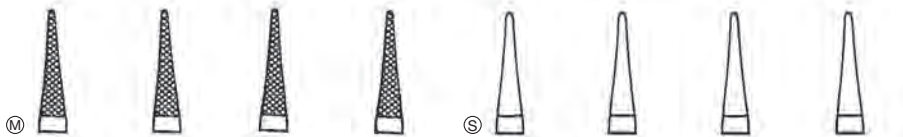

- 24-0444 14 cm/5½"
- 24-0445 15 cm/6"
- 24-0446 18 cm/7"
- 24-0447 20 cm/8"
- 24-0439 14 cm/5½"
- 24-0440 15 cm/6"
- 24-0441 18 cm/7"
- 24-0442 20 cm/8"



- 24-0400 14 cm/5½"
- 24-0401 17 cm/6½"
- 24-0402 19 cm/7½"

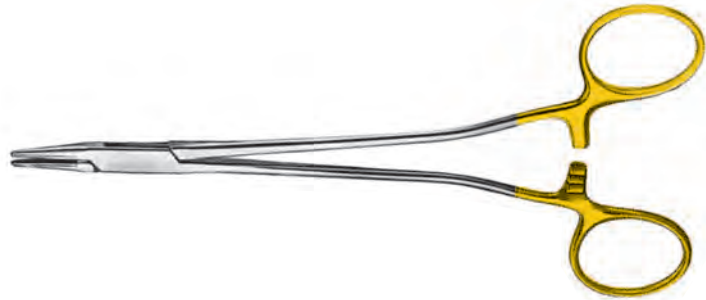

Sarot
1.9 mm



24-0331
18 cm/7"



24-0332
20 cm/8"



24-0333
23 cm/9"



24-0334
26 cm/10¼"



Castroviejo/Hepp-Scheidel
1.2 mm



24-0250
13 cm



24-0252
13 cm



03-0270
18 cm

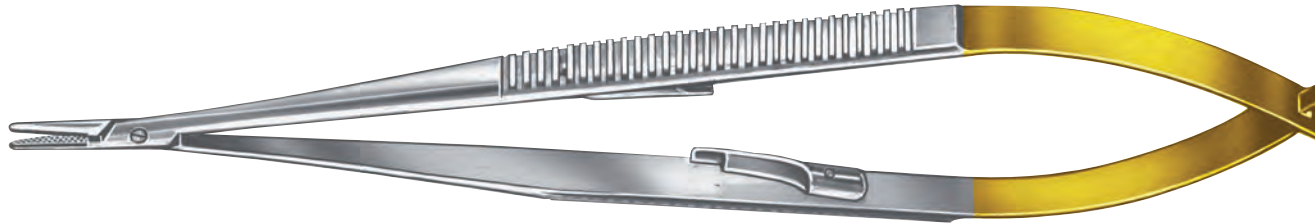

Castroviejo
1.2 mm

- | | | | | | | | | | | | |
|---------|---------|---------|---------|---------|---------|---------|---------|---------|---------|---------|---------|
| | | | | | | | | | | | |
| Ⓢ | | Ⓜ | | Ⓢ | | Ⓜ | | Ⓢ | | Ⓜ | |
| 24-0200 | 24-0201 | 24-0220 | 24-0221 | 24-0204 | 24-0205 | 24-0224 | 24-0225 | 24-0208 | 24-0209 | 24-0228 | 24-0229 |
| 14 cm | 14 cm | 14 cm | 14 cm | 18 cm | 18 cm | 18 cm | 18 cm | 21 cm | 21 cm | 21 cm | 21 cm |

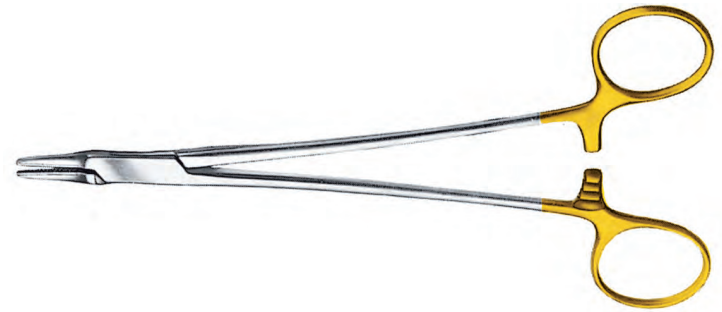

Giannini
1.3 mm

Giannini Heavy
1.9 mm

French-Eye (Ryder)
2.1 mm



24-0255
24 cm/9½"

24-0258
24 cm/9½"

24-0341	24-0342	24-0343	24-0344	24-0345
16 cm	18 cm	20 cm	24 cm	26 cm

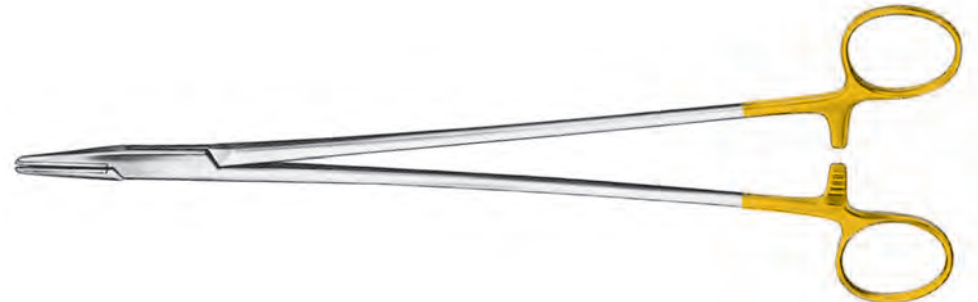

Neurosurgical

1.7 mm
(French Eye (Ryder) delicate)

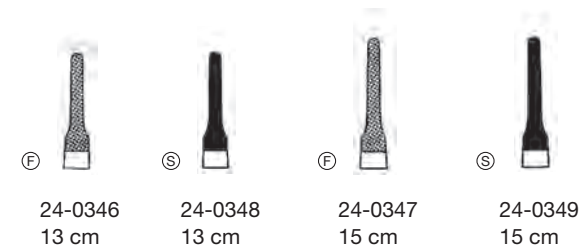

Wangensteen



24-0379
28 cm/11"



Derf
1.4 mm



Halsey
1.6 mm

Halsey-Webster
1.6 mm



Webster
1.5 mm



Baumgartner
2.1 mm



Ⓔ
24-0305
12 cm/4½"



24-0301
13 cm/5"
[24-0301.TI](#)



Ⓢ
24-0300
13 cm/5"



Ⓢ
24-0292
12 cm/4½"



Ⓜ
24-0291
12 cm/4½"



Ⓝ
24-0302
13 cm/5"

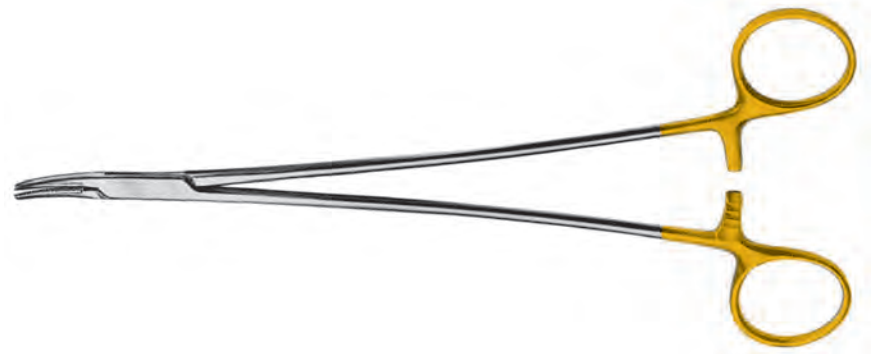
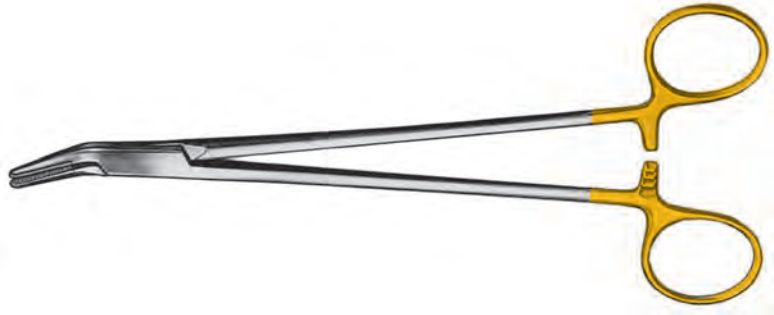

Finochietto

2.6 mm

Crile-Wood

curved 1.8 mm



Ⓕ

24-0148
21 cm/8¼"



24-0149
26 cm/10¼"



Ⓕ

24-0306
13 cm/5"



24-0316
15 cm/6"



24-0317
18 cm/7"



24-0318
20 cm/8"



24-0319
23 cm/9"

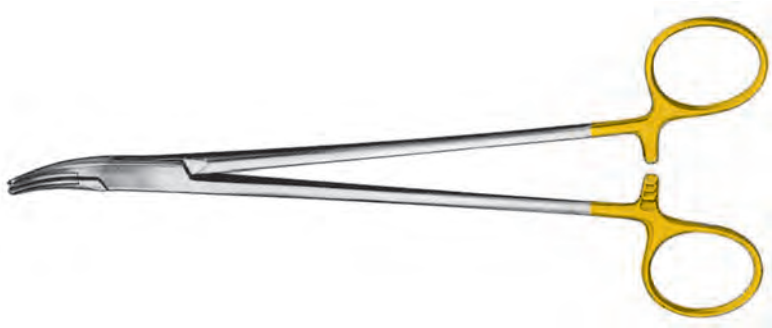

Heaney
2.6 mm



Ⓕ

24-0145
21 cm/8¼"



24-0146
23 cm/9"



24-0147
26 cm/10¼"



Diethrich Ryder
1.2 mm



Ⓜ

24-0420
16 cm



24-0421
18 cm



24-0422
20 cm



24-0423
23 cm



24-0424
26 cm

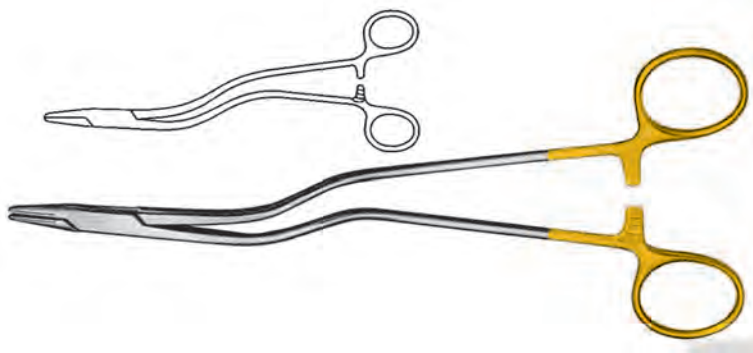

Masson-Lüthy
2.5 mm



24-0156
20 cm/8"



24-0157
25 cm/10"



Bozemann-Finochietto
2.5 mm



24-0158
20 cm/8"



24-0159
25 cm/10"



Kilner
1.9 mm



24-0303
13 cm/5"



Olsen-Hegar mini
1.8 mm



24-0160
12 cm/4"



Gillies
2.2 mm



24-0167
16 cm/6¼"



Neivert (Offset Ring)
1.7 mm



24-0304
13 cm/5"



Hegar
2.7 mm

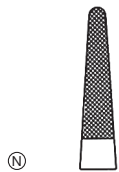

24-0150
20 cm/8"

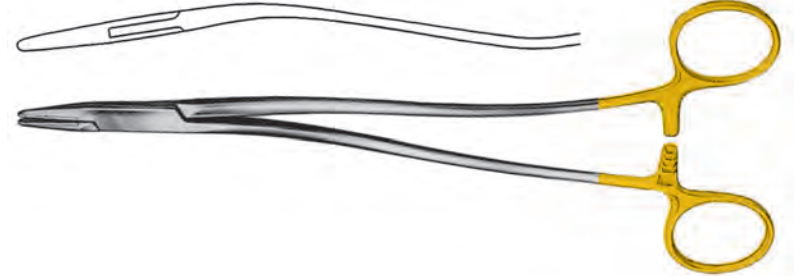

Bozemann (Wertheim)
2.7 mm



24-0140
20 cm/8"



24-0141
23 cm/9"



24-0142
26 cm/10 1/4"



24-0143
30 cm/12"

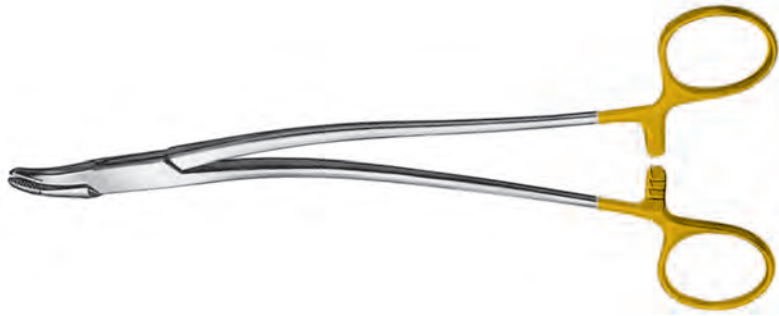

Stratte
2.7 mm

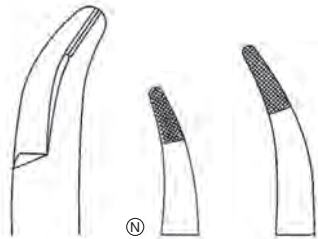

24-0372
20 cm/8"

24-0370
23 cm/9"

Stratte reverse
2.7 mm

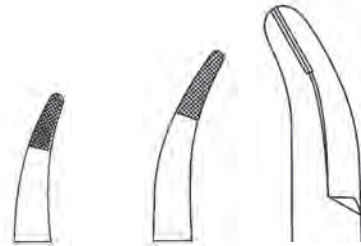

24-0373
20 cm/8"

24-0371
23 cm/9"

Zweifel
2.9 mm



24-0050
20 cm



Mathieu
2.4 mm



Mathieu
2.9 mm

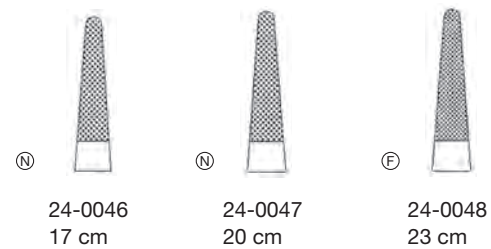

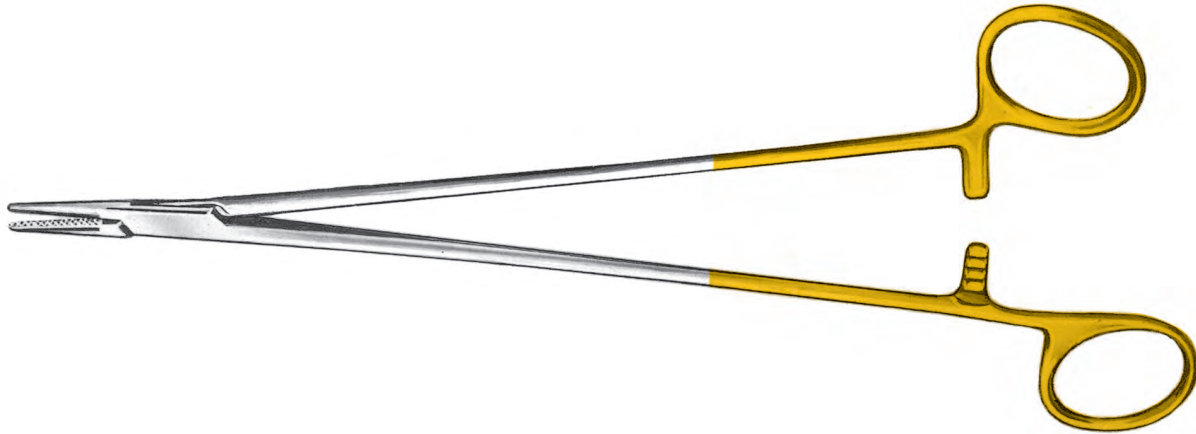

Crile-Wood

2.0 mm with extended ring

DeBakey

1.7 mm with extended ring



24-0762
19.5 cm/7 1/2"



24-0764
21.5 cm/8 1/4"



24-0766
24.5 cm/9 1/2"



24-0761
16.5 cm/6 1/4"



24-0763
19.5 cm/7 1/2"



24-0767
24.5 cm/9 1/2"



Left-hand Baumgartner
1.7 mm



24-7582.LH
13 cm/5"

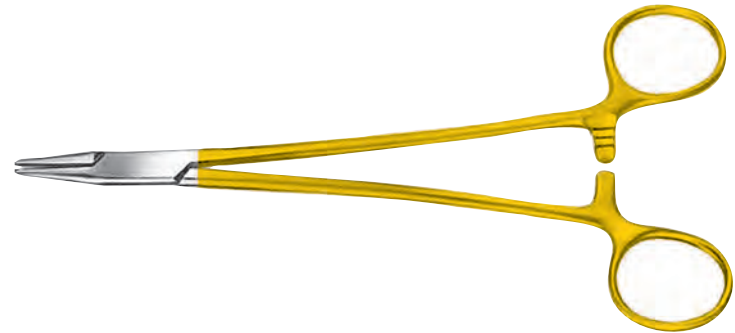

Left-hand Mayo-Hegar
2.5 mm



24-7530.LH
16 cm/6¼"



24-7531.LH
18 cm/7"



24-7532.LH
20 cm/8"

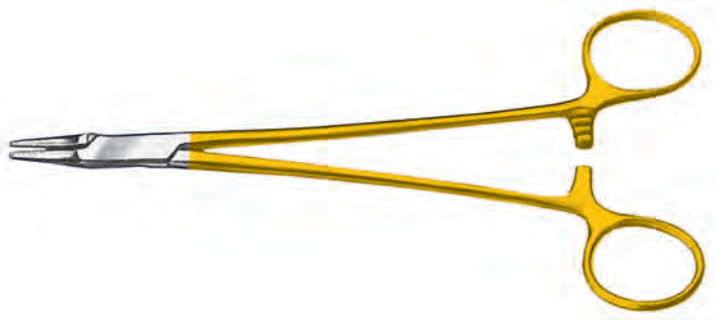

Left-hand French-Eye (Ryder)

1.9 mm



⑤ 24-7560.LH
16 cm/6¼"

24-7561.LH
18 cm/7"

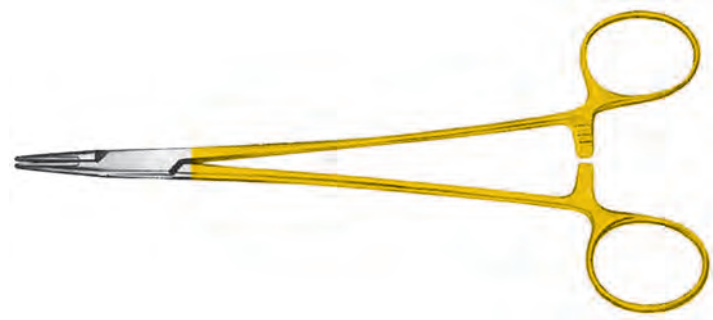

Left-hand DeBakey

1.9 mm



⑤ 24-7550.LH
18 cm/7"

24-7552.LH
23 cm/9"

24-7553.LH
26 cm/10¼"

24-7554.LH
30 cm/12"



Heavy Berry

6.0 mm

Wire Twister with TC-Inserts



24-0127
20 cm/8"



Rubio

4.8 mm

Mini Wire Twister with TC-Inserts



24-0128
13 cm/5"

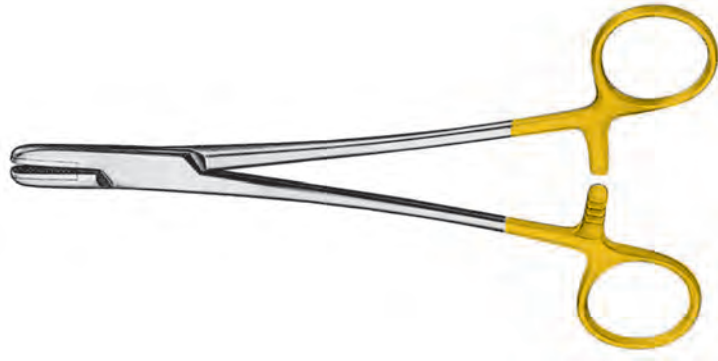

Berry
5.0 mm



©

24-0119
18 cm/7"



Automatic



®

24-0110
16 cm/6¼"



24-0105
16 cm/6¼"



24-0100
16 cm/6¼"



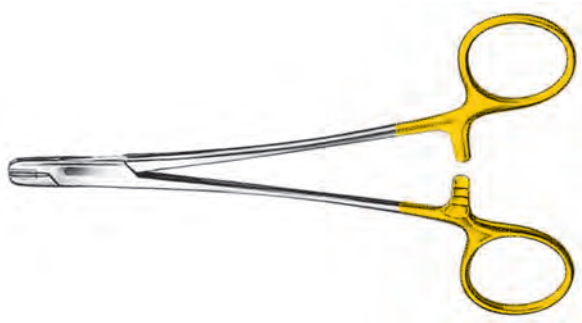

©

24-0115
18 cm/7"





Wire Twister

	2.5 mm	3.9 mm	3.0 mm
			
Ⓝ	24-0130 16 cm/6¼"	24-0125 16 cm/6¼"	24-0120 16 cm/6¼"
		24-0126 18 cm/7"	24-0121 18 cm/7"



Mathieu-Style

4.0 mm

		
ⓔ	24-0980 17 cm/6½"	24-0981 20 cm/8"



Wire Holding Forceps

14-0700
13 cm/5"



Izzat Wire-Grip

14-0710
without wire



Wire-Twister

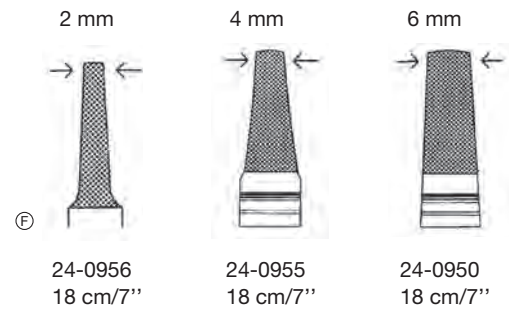



14-0669
14 cm/5½"



14-0670
17 cm/6½"

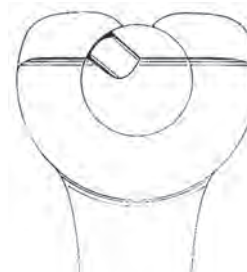

14-0675
16 cm/6¼"

Midi Cutter



18 cm

Midi Cutter



20 cm

Maxi Cutter

**Midi Cutter**

Art.-No.	Length	Wire max.
24-0906	18 cm	1.5 mm
24-0905	20 cm	1.5 mm

Maxi Cutter

Art.-No.	Length	Wire max.
24-0910	18 cm	1.7 mm
24-0920	22 cm	2.2 mm



Power Cutter

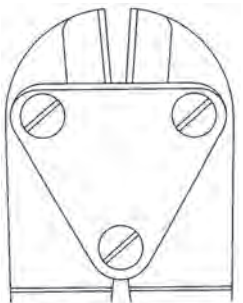

also recommended for plates
24-0940
24 cm/3.5 mm



– removeable handles –
24-0930
57 cm/6.5 mm