

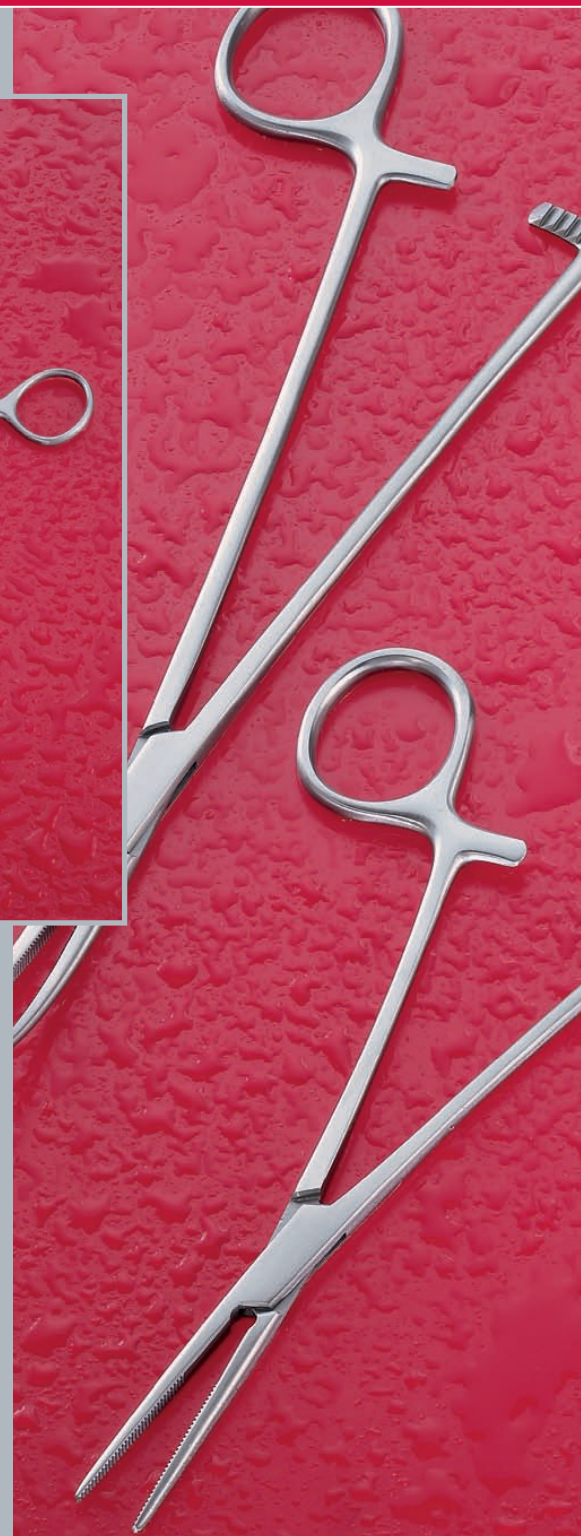

Arterienklemmen | Pinces hémostatiques
Haemostatic forceps | *Pinzas hemostáticas*
 Pinze emostatiche



Gefäßklemmen | Serre-fines
 Haemostatic forceps | Serrafinas
 Serrafine



DIEFFENBACH		
35 mm – 1½"	tk 11930-03	tk 11931-03
50 mm – 2"	tk 11930-05	tk 11931-05
60 mm – 2¼"	tk 11930-06	tk 11931-06



JOHNS HOPKINS	
50 mm – 2"	tk 11935-05
65 mm – 2½"	tk 11935-06
75 mm – 3"	tk 11935-07



DIETRICH

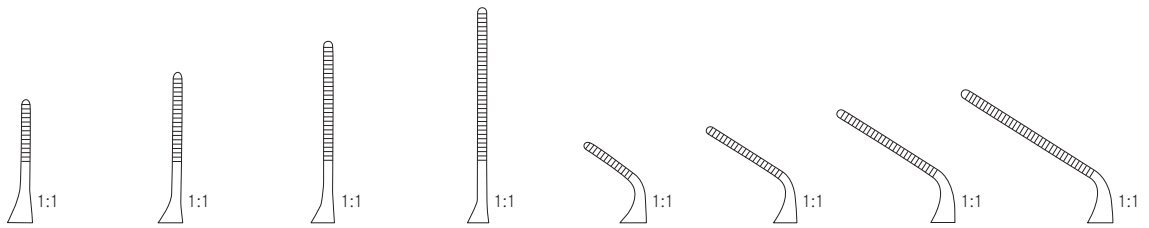

x=	50 mm – 2"	50 mm – 2"	50 mm – 2"	60 mm – 2¼"	50 mm – 2"	50 mm – 2"	50 mm – 2"	60 mm – 2¼"
y=	8 mm	12 mm	16 mm	20 mm	8 mm	12 mm	16 mm	20 mm
	tk 11940-08	tk 11940-12	tk 11940-16	tk 11940-20	tk 11941-08	tk 11941-12	tk 11941-16	tk 11941-20

x = Länge | y = geriefte Maullänge
 Length | serrated jaw part
 Longueur | partie striée du mors
 Longitud | parte estriada de la boca
 Lunghezza | morso zigrinato



Atraumatische Klemmen sind abgebildet von Seite 383 bis 418
 Atraumatic forceps, please see the pages 383 to 418
 Pincas atraumáticas, voire pages 383 à 418
 Pinzas atraumáticas, ver paginas 383 a 418
 Pinze atraumatiche, vedete pagina 383 a 418

Arterienklemmen
Haemostatic forceps

Pinces hémostatiques
Pinzas hemostáticas
Pinze emostatiche

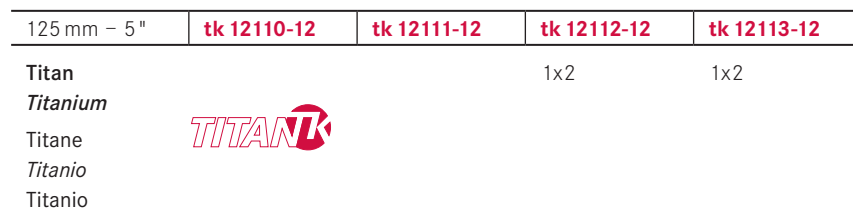
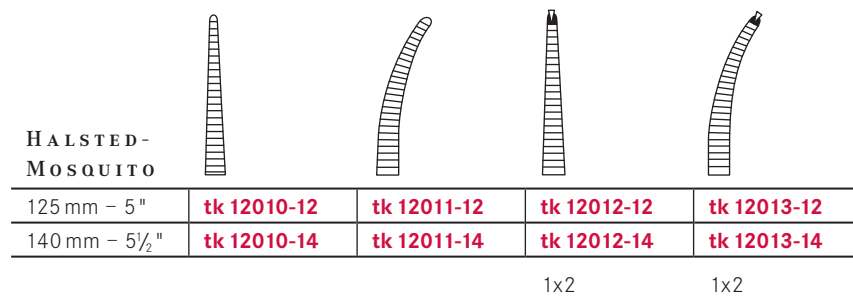
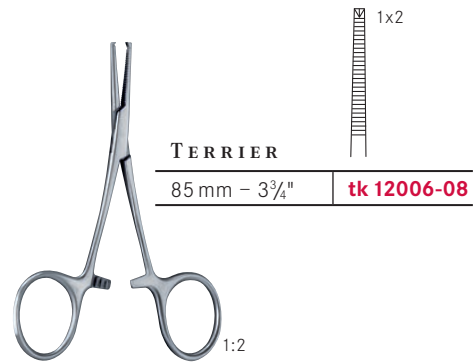
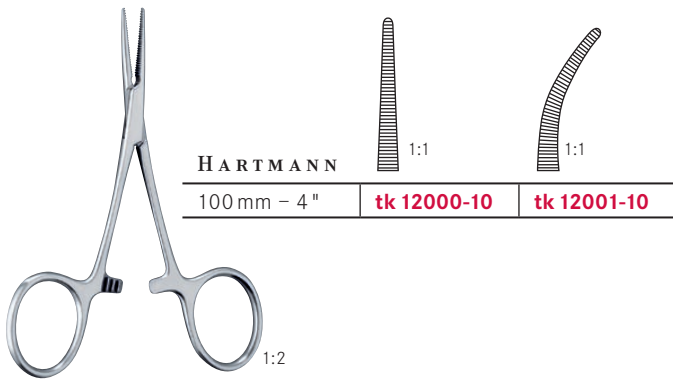

Arterienklemmen
Haemostatic forceps

Pinces hémostatiques
Pinzas hemostáticas
Pinze emostatiche



MICRO-
MOSQUITO

100 mm – 4"	tk 12020-10	tk 12021-10	tk 12022-10	tk 12023-10
120 mm – 4 3/4"	tk 12020-12	tk 12021-12	tk 12022-12	tk 12023-12

1x2

1x2



PROVIDENCE-
HOSPITAL

140 mm – 5 1/2"	tk 12020-14	tk 12021-14
-----------------	-------------	-------------

1:2

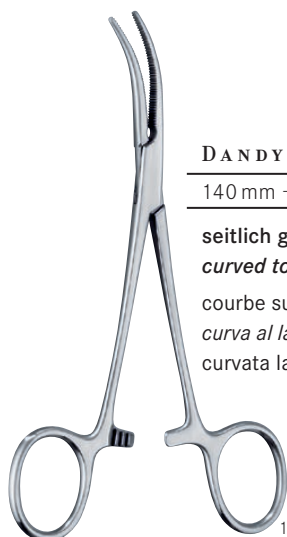

DANDY

140 mm – 5 1/2"	tk 12030-14	tk 12032-14
-----------------	-------------	-------------

seitlich gebogen
curved to the side
courbe sur le plat
curva al lado
curvata lateralmente

1x2



MOSQUITO-
DANDY

120 mm – 4 3/4"	tk 12031-12
-----------------	-------------

seitlich gebogen
curved to the side
courbe sur le plat
curva al lado
curvata lateralmente

1:2

Arterienklemmen
Haemostatic forceps

Pinces hémostatiques
Pinzas hemostáticas
Pinze emostatiche



CHRISTOPHE

130 mm – 4 "	tk 12039-13
150 mm – 6 "	tk 12039-15

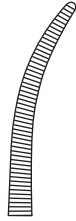

LOVELACE

155 mm – 6 "	tk 12195-15	tk 12196-15
--------------	--------------------	--------------------

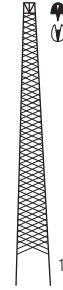

1:1

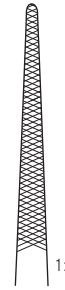

1:1

1x2

1:2



LERICHE

150 mm – 6 "	tk 12034-15	tk 12035-15
--------------	--------------------	--------------------



1:1

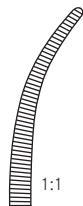

1:1

1:2



LERICHE

150 mm – 6 "	tk 12036-15	tk 12037-15
--------------	--------------------	--------------------



1:1

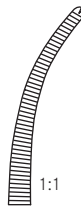

1:1

1x2

1x2

1:2

Arterienklemmen
Haemostatic forceps

Pinces hémostatiques
Pinzas hemostáticas
Pinze emostatiche

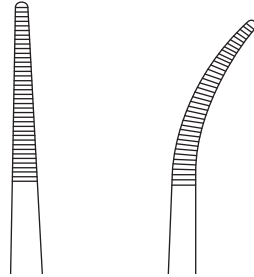

KELLY

140 mm – 5½"	tk 12040-14	tk 12041-14
--------------	-------------	-------------

KELLY-RANKIN

160 mm – 6¼"	tk 12040-16	tk 12041-16
--------------	-------------	-------------

KELLY

140 mm – 5½"	tk 12140-14	tk 12141-14
--------------	-------------	-------------

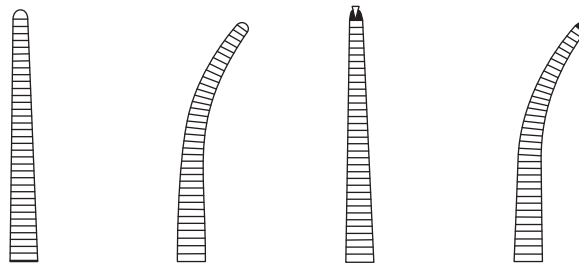

CRILE

140 mm – 5½"	tk 12050-14	tk 12051-14	tk 12052-14	tk 12053-14
--------------	-------------	-------------	-------------	-------------

1x2

1x2

CRILE-RANKIN

160 mm – 6¼"	tk 12050-16	tk 12051-16	tk 12054-16	tk 12055-16
--------------	-------------	-------------	-------------	-------------

1x2

1x2

CRILE

140 mm – 5½"	tk 12250-14	tk 12251-14
--------------	-------------	-------------



**Arterienklemmen
Haemostatic forceps**
**Pinces hémostatiques
Pinzas hemostáticas
Pinze emostatiche**

COLLER

140 mm – 5½"	tk 12056-14	tk 12057-14
160 mm – 6¼"	tk 12056-16	tk 12057-16

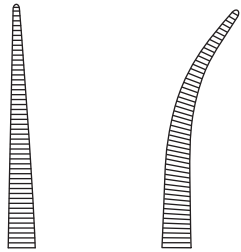

PÉAN

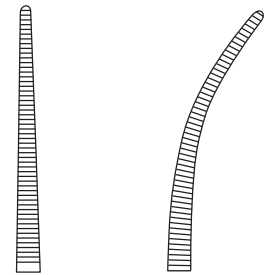
130 mm – 5"	tk 12058-13	tk 12059-13
140 mm – 5½"	tk 12058-14	tk 12059-14
160 mm – 6¼"	tk 12058-16	tk 12059-16

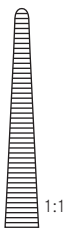

**graziles Modell
delicate pattern
modèle délicat
modelo delicado
modello delicato**

DUNHILL

125 mm – 5"	tk 12268-12
-------------	--------------------

CAIRNS

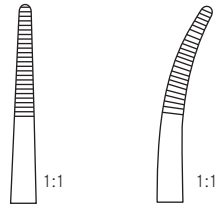
150 mm – 6"	tk 12269-01	tk 12269-02
-------------	--------------------	--------------------

KOCHER

130 mm – 5"	tk 12078-13	tk 12079-13
140 mm – 5½"	tk 12078-14	tk 12079-14
160 mm – 6¼"	tk 12078-16	tk 12079-16

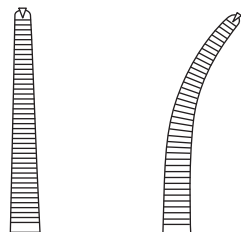
**graziles Modell
delicate pattern
modèle délicat
modelo delicado
modello delicato**

1x2

1x2

Arterienklemmen
Haemostatic forceps

Pinces hémostatiques
Pinzas hemostáticas
Pinze emostatiche



PÉAN-FINO	1:1	1:1	1:1	1:1	1:1	1:1
	145 mm – 5 3/4"	165 mm – 6 1/2"	185 mm – 7 1/4"	140 mm – 5 1/2"	160 mm – 6 1/4"	180 mm – 7"
tk 12062-14	tk 12062-16	tk 12062-18	tk 12063-14	tk 12063-16	tk 12063-18	







KOCHER-FINO	1:1	1:1	1:1	1:1	1:1	1:1
	145 mm – 5 3/4"	165 mm – 6 1/2"	185 mm – 7 1/4"	145 mm – 5 3/4"	160 mm – 6 1/4"	180 mm – 7"
tk 12082-14	tk 12082-16	tk 12082-18	tk 12083-14	tk 12083-16	tk 12083-18	
1x2	1x2	1x2	1x2	1x2	1x2	

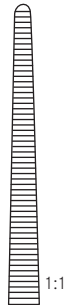

Arterienklemmen
Haemostatic forceps

Pinces hémostatiques
Pinzas hemostáticas
Pinze emostatiche

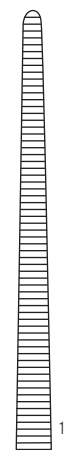
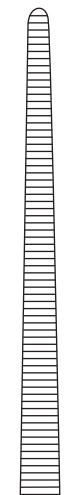

ROCHESTER-
PÉAN

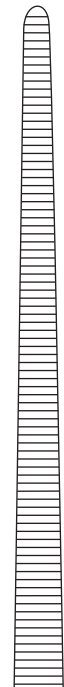
				
140 mm – 5½"	160 mm – 6¼"	180 mm – 7"	200 mm – 8"	220 mm – 8¾"
tk 12060-14	tk 12060-16	tk 12060-18	tk 12060-20	tk 12060-22

			
240 mm – 9½"	260 mm – 10¼"	300 mm – 12"	350 mm – 14"
tk 12060-24	tk 12060-26	tk 12060-30	tk 12060-35

Arterienklemmen
Haemostatic forceps

Pinces hémostatiques
Pinzas hemostáticas
Pinze emostatiche

ROCHESTER-PÉAN

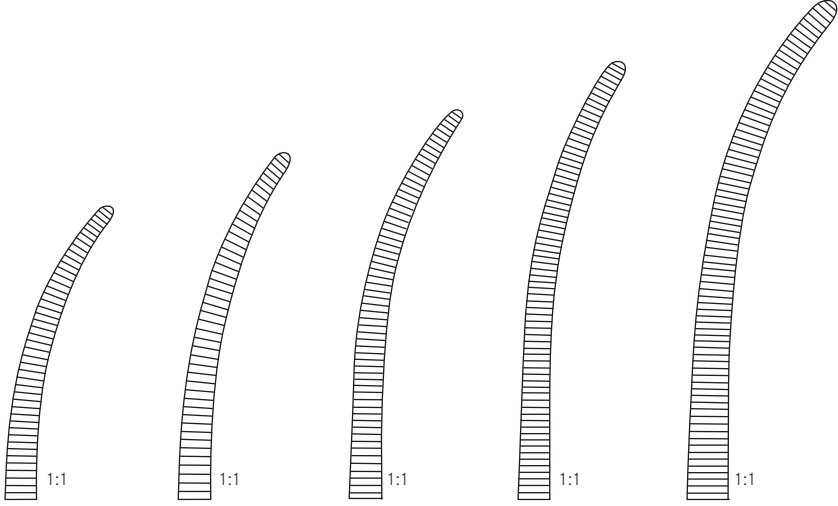

140 mm – 5½"	160 mm – 6¼"	180 mm – 7"	200 mm – 8"	220 mm – 8¾"
tk 12061-14	tk 12061-16	tk 12061-18	tk 12061-20	tk 12061-22

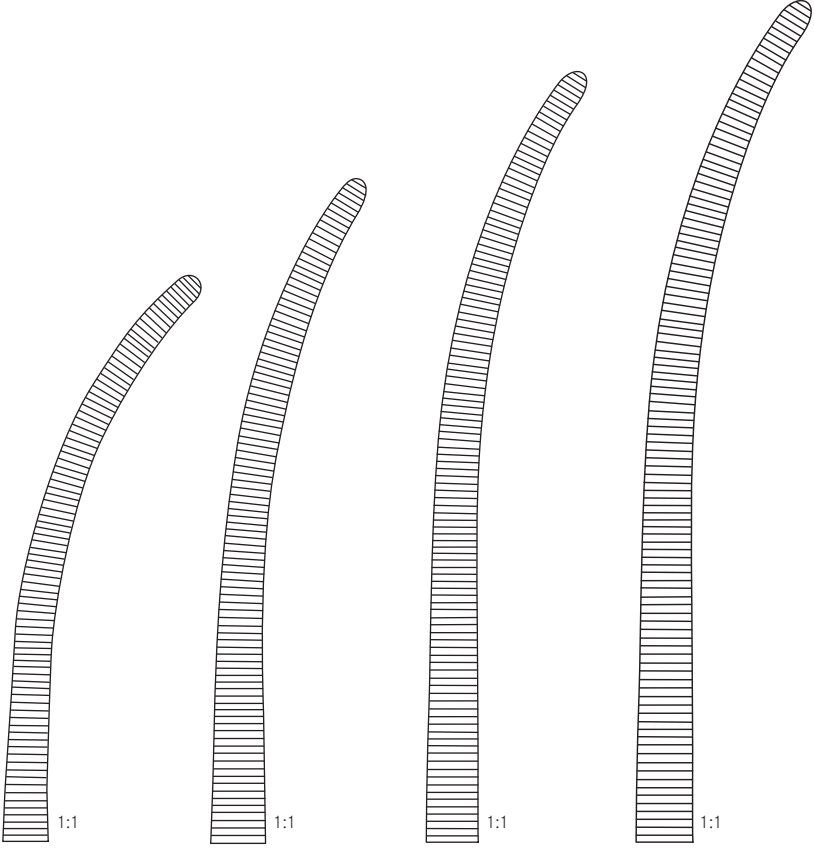

240 mm – 9½"	260 mm – 10¼"	300 mm – 12"	350 mm – 14"
tk 12061-24	tk 12061-26	tk 12061-30	tk 12061-35

Arterienklemmen
Haemostatic forceps

Pinces hémostatiques
Pinzas hemostáticas
Pinze emostatiche



OCHSNER-
KOCHER

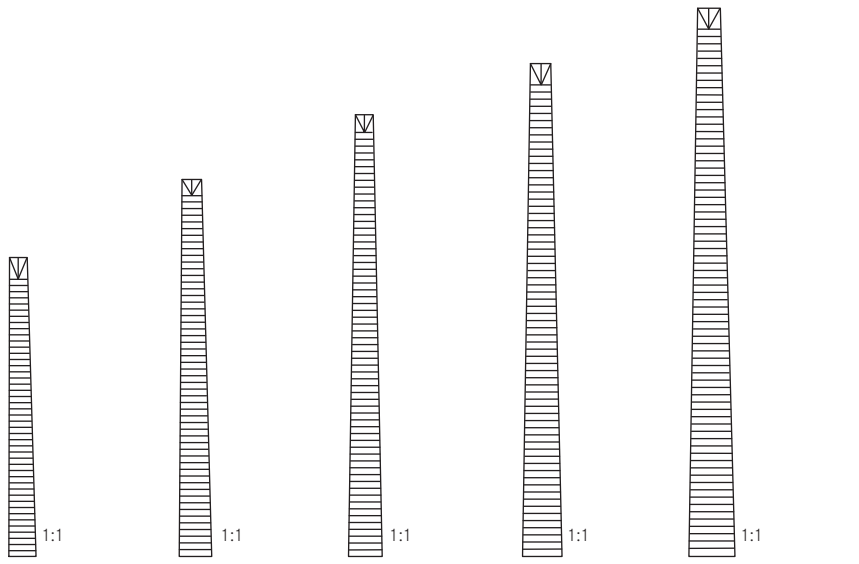

140 mm – 5½"	160 mm – 6¼"	180 mm – 7"	200 mm – 8"	220 mm – 8¾"
tk 12080-14	tk 12080-16	tk 12080-18	tk 12080-20	tk 12080-22
1x2	1x2	1x2	1x2	1x2

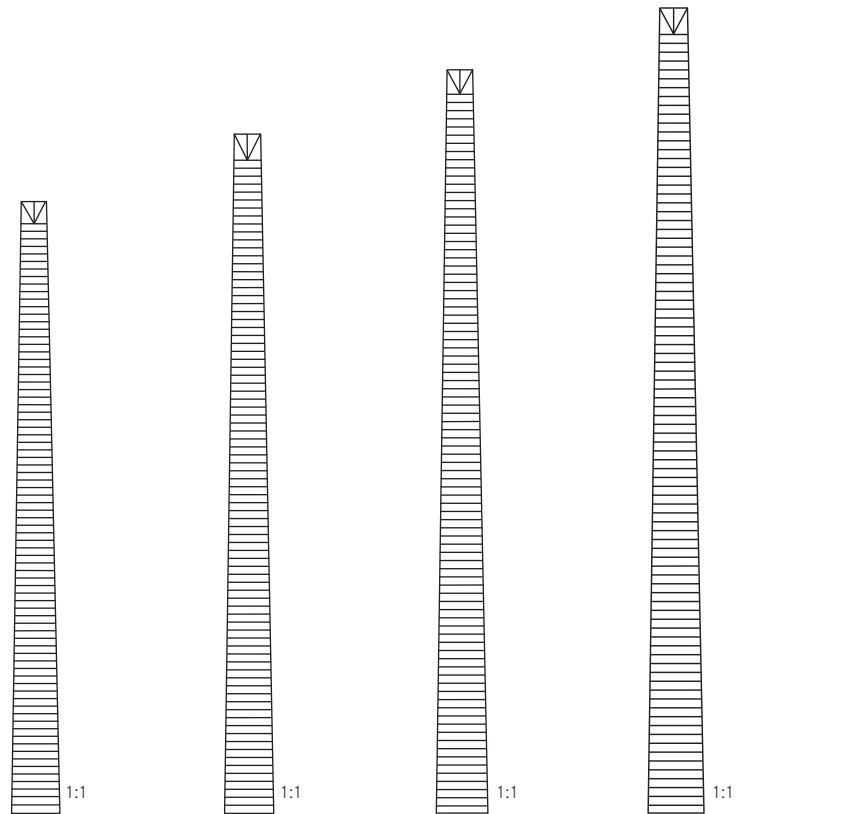

240 mm – 9½"	260 mm – 10¼"	300 mm – 12"	300 mm – 14"
tk 12080-24	tk 12080-26	tk 12080-30	tk 12080-35
1x2	1x2	1x2	1x2

Arterienklemmen
Haemostatic forceps

Pinces hémostatiques
Pinzas hemostáticas
Pinze emostatiche

OCHSNER-KOCHER

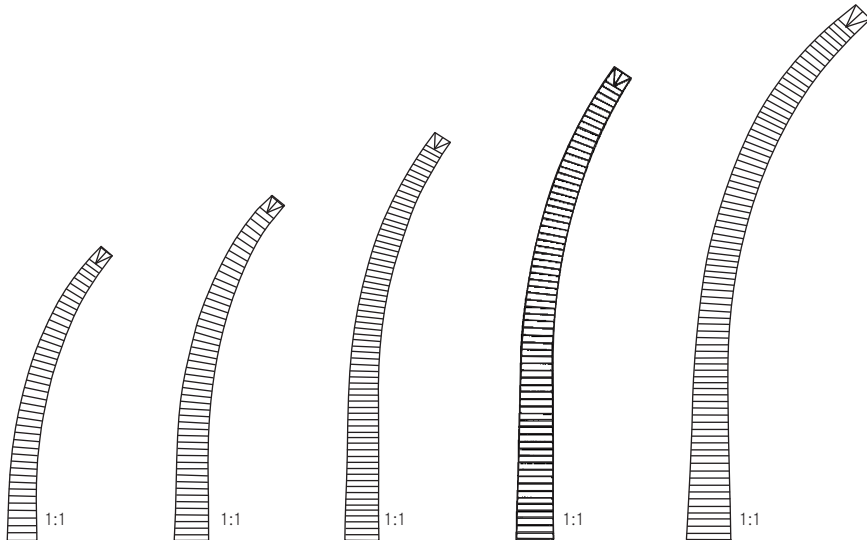

140 mm – 5½"	160 mm – 6¼"	180 mm – 7"	200 mm – 8"	220 mm – 8¾"
tk 12081-14	tk 12081-16	tk 12081-18	tk 12081-20	tk 12081-22
1x2	1x2	1x2	1x2	1x2

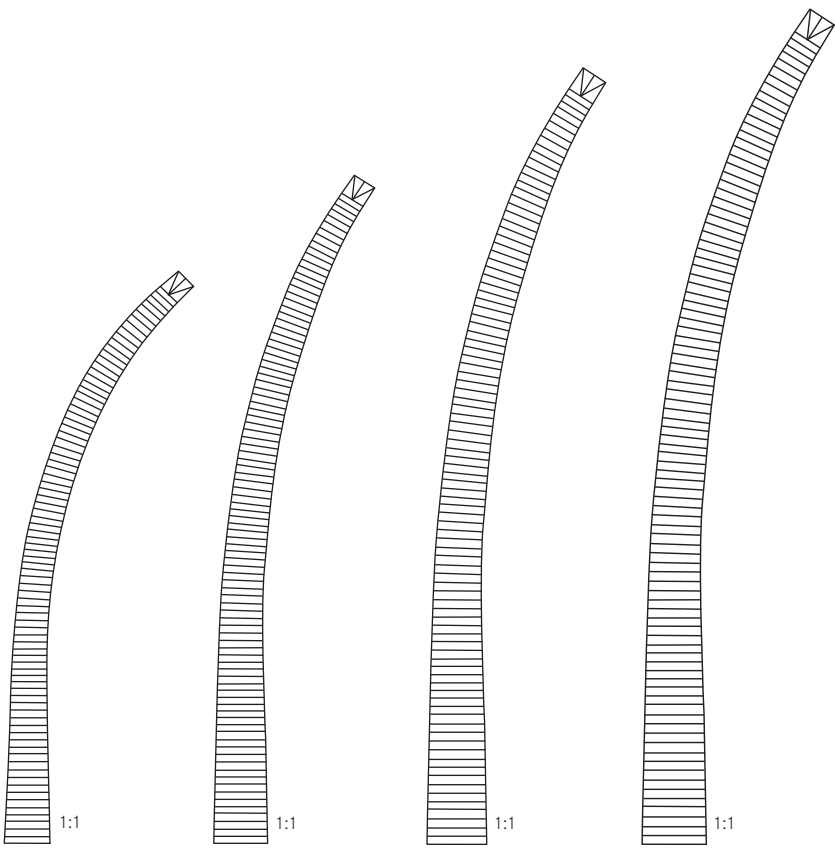

240 mm – 9½"	260 mm – 10¼"	300 mm – 12"	350 mm – 14"
tk 12081-24	tk 12081-26	tk 12081-30	tk 12081-35
1x2	1x2	1x2	1x2

Arterienklemmen
Haemostatic forceps

Pinces hémostatiques
Pinzas hemostáticas
Pinze emostatiche



BIRKET

190 mm – 7½"

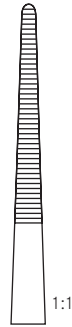

tk 12094-19

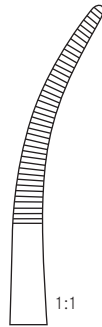

tk 12095-19



BAINBRIDGE

150 mm – 6"



tk 12120-15

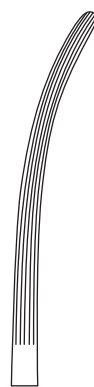

tk 12121-15

185 mm – 7¼"

tk 12120-18

tk 12121-18

Arterienklemmen
Haemostatic forceps

Pinces hémostatiques
Pinzas hemostáticas
Pinze emostatiche



PÉAN

140 mm – 5½"	tk 12150-14
160 mm – 6¼"	tk 12150-16



ROCHESTER-CARMALT

160 mm – 6¼"	tk 12170-16	tk 12171-16
200 mm – 8"	tk 12170-20	tk 12171-20

Arterienklemmen
Haemostatic forceps

Pinces hémostatiques
Pinzas hemostáticas
Pinze emostatiche



CHAPUT

130 mm – 5"

tk 12156-13



TUFFIER

130 mm – 5"

tk 12158-13

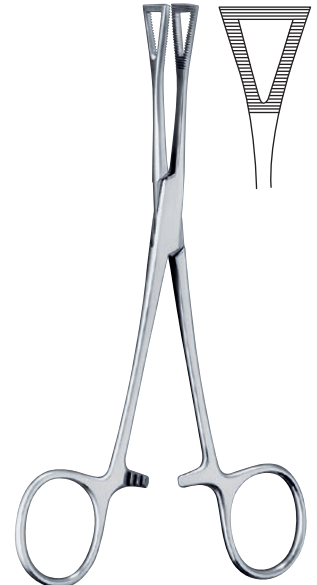

PENNINGTON

155 mm – 6"

tk 12160-15

200 mm – 8"

tk 12160-20

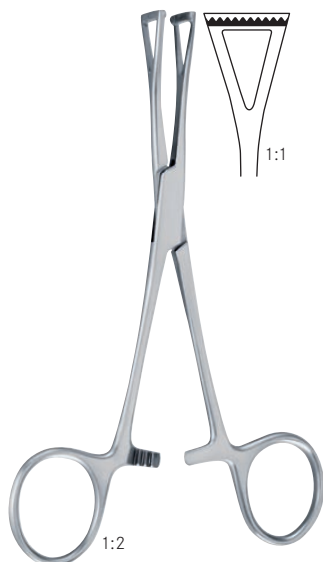

COLLIN

140 mm – 5½"

tk 12162-14



PRATT

150 mm – 6"

tk 12172-15



MARTEL

140 mm – 5½"

tk 12174-14

Arterienklemmen
Haemostatic forceps

Pinces hémostatiques
Pinzas hemostáticas
Pinze emostatiche

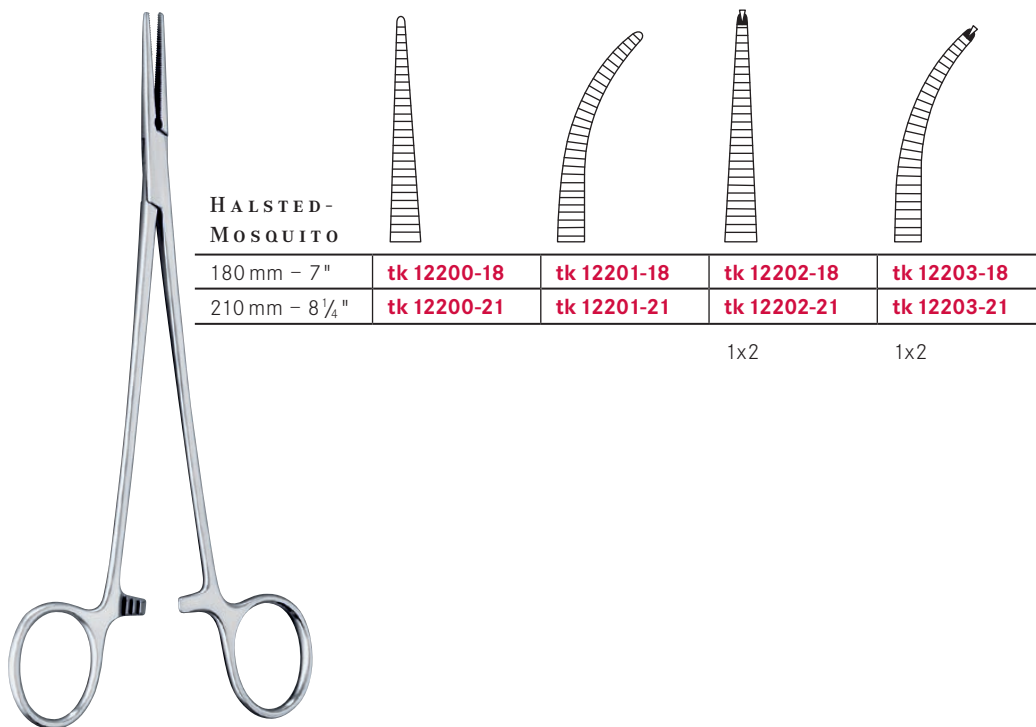

Arterienklemmen
Haemostatic forceps

Pinces hémostatiques
Pinzas hemostáticas
Pinze emostatiche

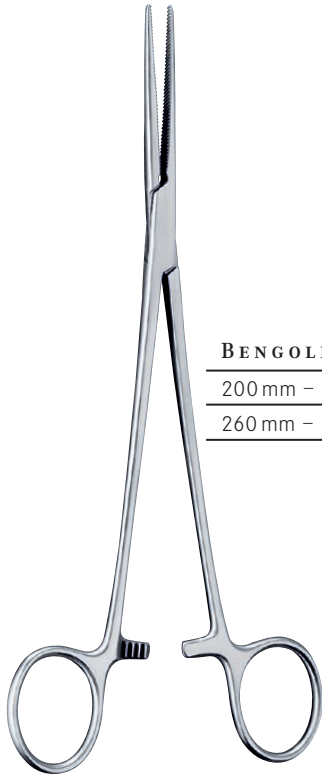

BENGOLEA

200 mm – 8"	tk 12205-20	tk 12206-20	tk 12207-20	tk 12208-20
260 mm – 10¼"	tk 12205-26	tk 12206-26	tk 12207-26	tk 12208-26
			1x2	1x2



ADSON

185 mm – 7¼"	tk 12210-18	tk 12211-18	tk 12212-18	tk 12213-18
			1x2	1x2

Arterienklemmen
Haemostatic forceps

Pinces hémostatiques
Pinzas hemostáticas
Pinze emostatiche



HEISS

200 mm – 8"

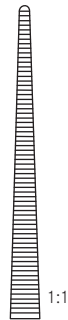

1:1

tk 12230-20

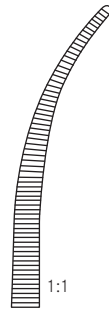

1:1

tk 12231-20

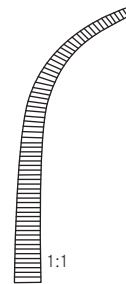

1:1

tk 12233-20

Arterienklemmen
Haemostatic forceps

Pinces hémostatiques
Pinzas hemostáticas
Pinze emostatiche



BABY-MIXTER

140 mm – 5½"

180 mm – 7"

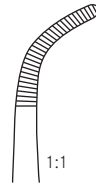
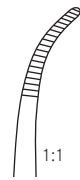

tk 12220-14

tk 12220-18



BABY-ADSON

140 mm – 5½"

180 mm – 7"

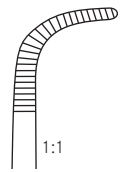
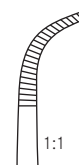

tk 12221-14

tk 12221-18



BABY-OVERHOLT

135 mm – 5¼"

tk 12287-14

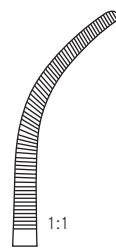

1:2

Arterienklemmen
Haemostatic forceps

Pinces hémostatiques
Pinzas hemostáticas
Pinze emostatiche

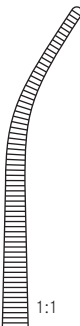
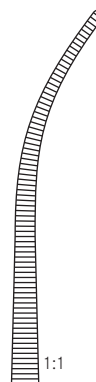
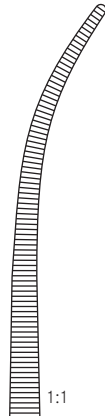

KELLY-FRASER			
	1:1	1:1	1:1
	Fig. 1	Fig. 1	Fig. 1
	195 mm – 7 3/4"	225 mm – 8 3/4"	245 mm – 9 3/4"
	tk 12223-19	tk 12223-22	tk 12223-24

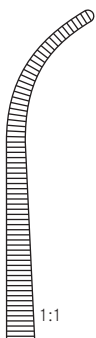
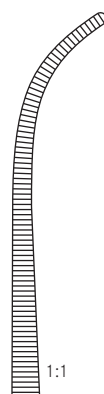
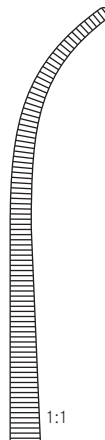
		
1:1	1:1	1:1
Fig. 2	Fig. 2	Fig. 2
190 mm – 7 1/2"	220 mm – 8 3/4"	240 mm – 9 1/2"
tk 12225-19	tk 12225-22	tk 12225-24

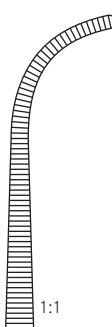
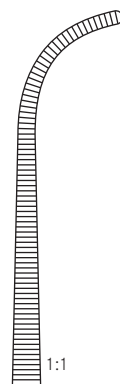
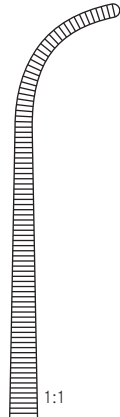
		
1:1	1:1	1:1
Fig. 3	Fig. 3	Fig. 3
185 mm – 7 1/4"	215 mm – 8 1/2"	235 mm – 9 1/4"
tk 12227-19	tk 12227-22	tk 12227-24

Arterienklemmen
Haemostatic forceps

Pinces hémostatiques
Pinzas hemostáticas
Pinze emostatiche



SCHNIDT

190 mm – 7 1/2"



1:1

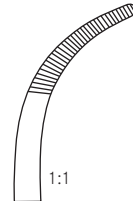

1:1

tk 12241-19

tk 12243-19

1:2



TOENNIS

210 mm – 8 1/4"

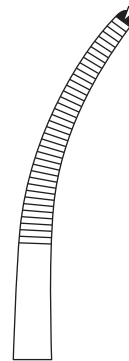
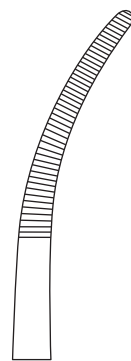

tk 12250-21

tk 12251-21

tk 12252-21

tk 12253-21

260 mm – 10 1/4"

tk 12250-26

tk 12251-26

tk 12252-26

tk 12253-26

1x2

1x2

Arterienklemmen
Haemostatic forceps

Pinces hémostatiques
Pinzas hemostáticas
Pinze emostatiche

RUMEL	Fig. 1	Fig. 2	Fig. 3	Fig. 4	Fig. 5
230 mm – 9"	tk 12261-23	tk 12262-23	tk 12263-23	tk 12264-23	tk 12265-23

MEEKER	
180 mm – 7"	tk 12091-18
275 mm – 10 ³ / ₄ "	tk 12091-27

gebogen, 90°
curved, 90°
courbe, 90°
curva, 90°
curve, 90°

LAWRENCE	
280 mm – 11"	tk 12093-28

Präparier- und Ligaturklemmen
Dissecting and ligature forceps

Pinces à disséquer et à sutures
Pinzas para preparación y suturas
Pinze per preparazioni e suture



OVERHOLT-
GEISSENDOERFER

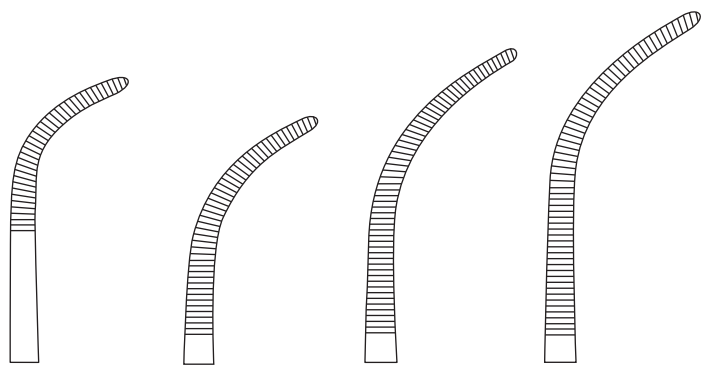

	Fig. 0	Fig. 1	Fig. 2	Fig. 3
210 mm – 8 1/4"	tk 12280-21	tk 12281-21	tk 12282-21	tk 12283-21
270 mm – 10 3/4"	tk 12280-27	tk 12281-27	tk 12282-27	tk 12283-27

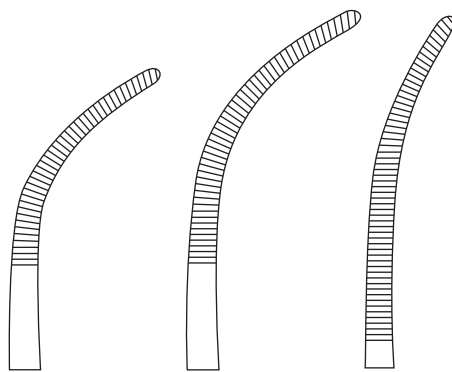

	Fig. 4	Fig. 5	Fig. 6
210 mm – 8 1/4"	tk 12284-21	tk 12285-21	tk 12286-21
270 mm – 10 3/4"	tk 12284-27	tk 12285-27	tk 12286-27

Präparier- und Ligaturklemmen
Dissecting and ligature forceps

Pinces à disséquer et à sutures
Pinzas para preparación y suturas
Pinze per preparazioni e suture



OVERHOLT-FINO

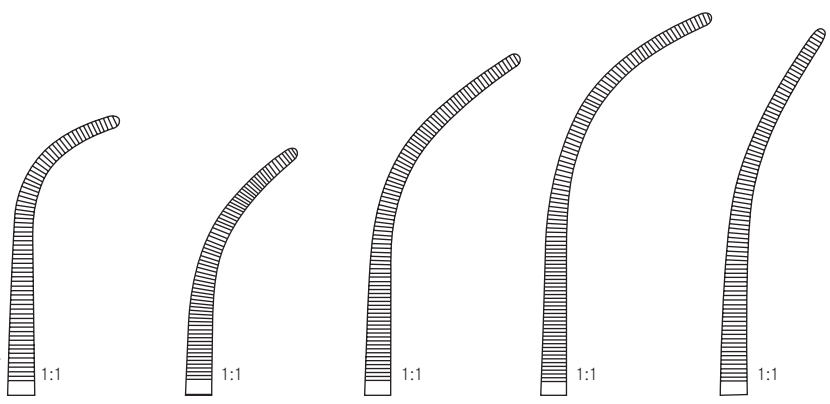

Fig. 0	Fig. 1	Fig. 2	Fig. 3	Fig. 6
215 mm – 8½"	210 mm – 8¼"	220 mm – 8¾"	230 mm – 9"	225 mm – 8¾"
tk 12287-00	tk 12287-01	tk 12287-02	tk 12287-03	tk 12287-06



OVERHOLT

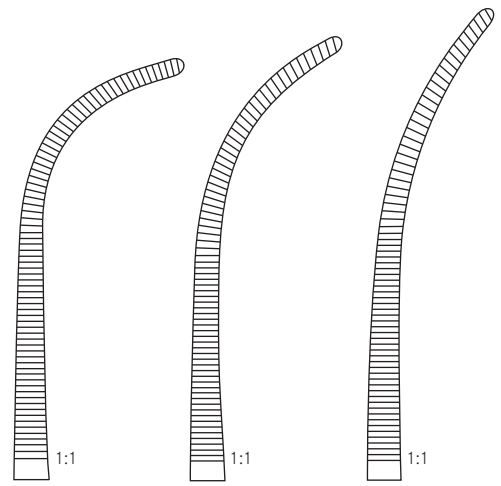
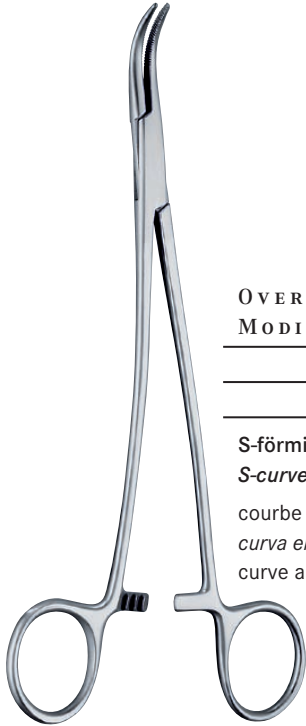

Fig. 0	Fig. 1	Fig. 6
295 mm – 8½"	295 mm – 8½"	300 mm – 8¾"
tk 12288-00	tk 12288-01	tk 12288-06

Präparier- und Ligaturklemmen
Dissecting and ligature forceps

Pinces à disséquer et à sutures
Pinzas para preparación y suturas
Pinze per preparazioni e suture



OVERHOLT-
MODIFIZIERT

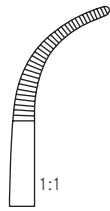

185 mm – 7 ¼"

tk 12235-01

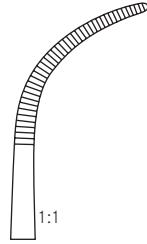

205 mm – 8"

tk 12235-02

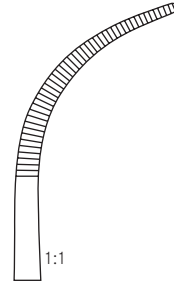

210 mm – 8 ¼"

tk 12235-03

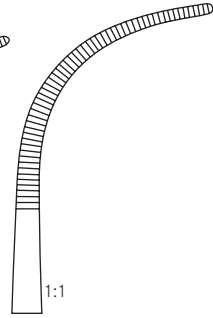

215 mm – 8 ½"

tk 12235-04

S-förmig gebogen
S-curved
courbe en S
curva en S
curve a forma di S

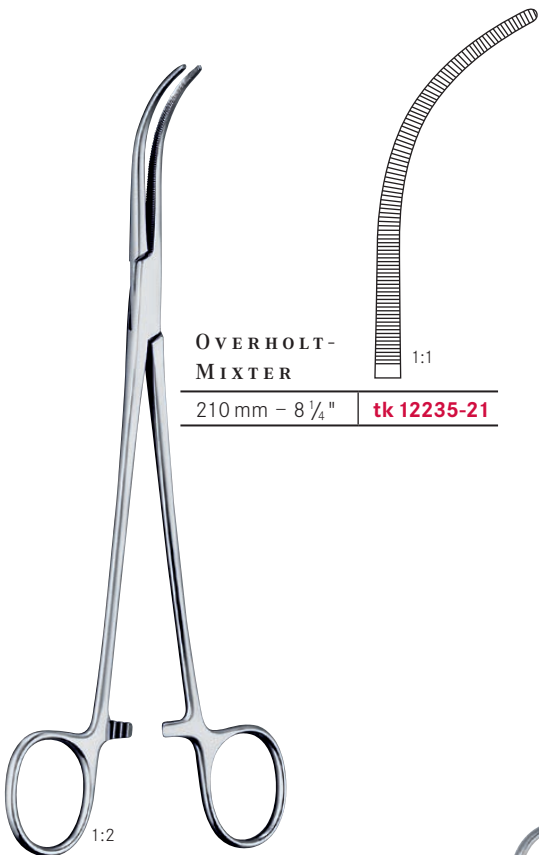

OVERHOLT-
MIXTER

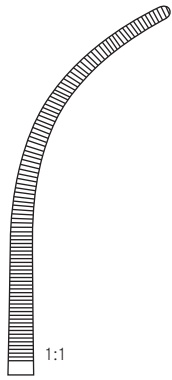

210 mm – 8 ¼"

tk 12235-21

1:2

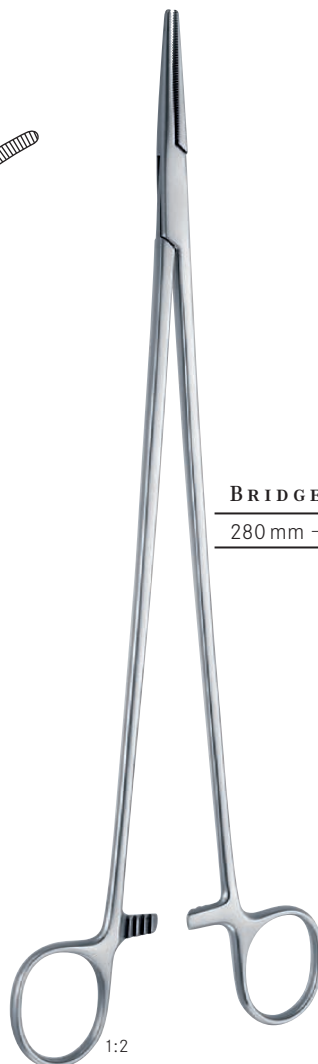

BRIDGE

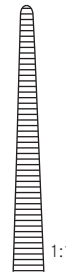

280 mm – 11"

tk 12238-28

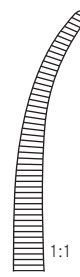

tk 12239-28

1:2

Präparier- und Ligaturklemmen
Dissecting and ligature forceps

Pinces à disséquer et à sutures
Pinzas para preparación y suturas
Pinze per preparazioni e suture



GEMINI

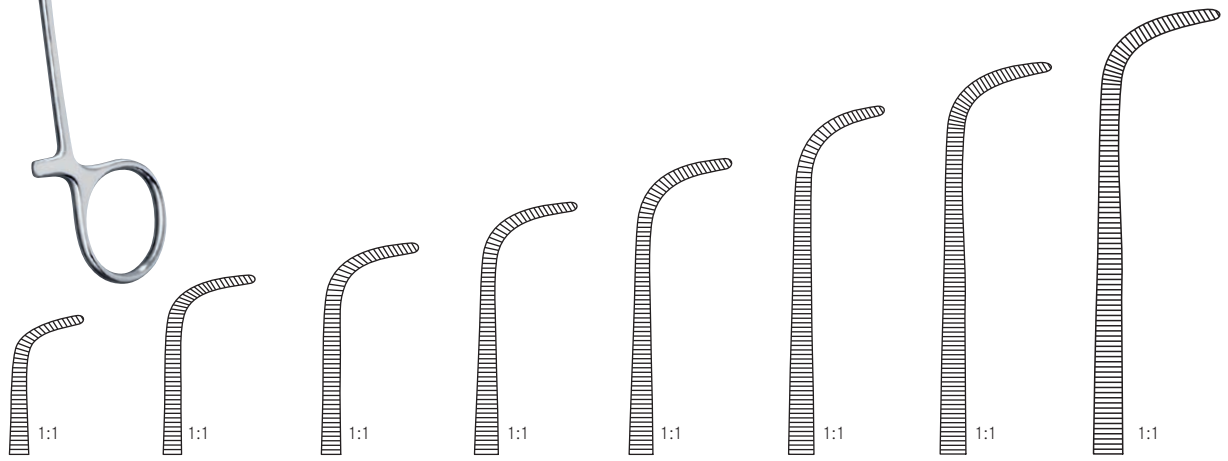

130 mm – 5 "	160 mm – 6¼ "	180 mm – 7 "	200 mm – 8 "	230 mm – 9 "	250 mm – 9¾ "	280 mm – 11 "	350 mm – 14 "
tk 12290-13	tk 12290-16	tk 12290-18	tk 12290-20	tk 12290-23	tk 12290-25	tk 12290-28	tk 12290-35



MINI-GEMINI

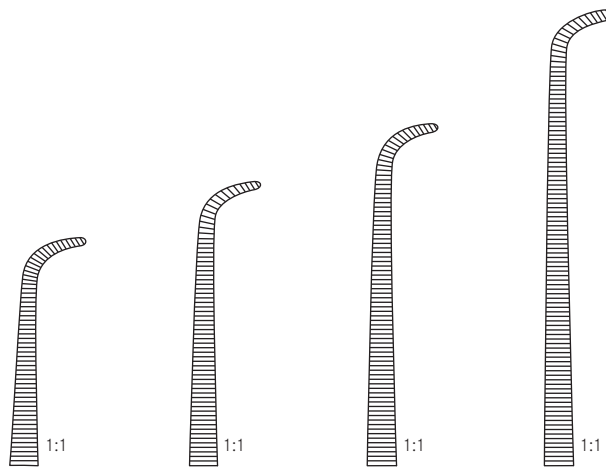

180 mm – 7 "	220 mm – 8¾ "	250 mm – 9¾ "	280 mm – 11 "
tk 12291-18	tk 12291-22	tk 12291-25	tk 12291-28

Präparier- und Ligaturklemmen
Dissecting and ligature forceps

Pincès à disséquer et à sutures
Pinzas para preparación y suturas
Pinze per preparazioni e suture

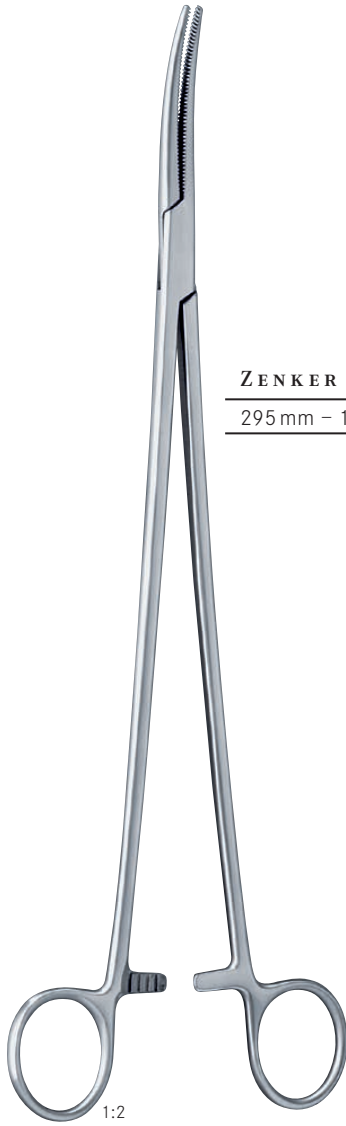

ZENKER

295 mm – 11½"

tk 12267-01

tk 12267-02

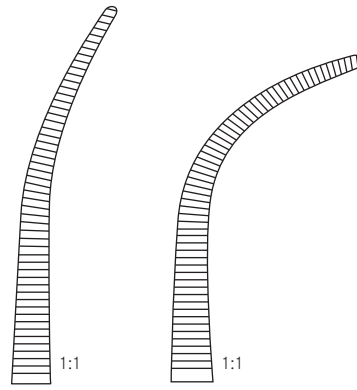

ROBERTS

220 mm – 8¾"

tk 12270-22

tk 12271-22

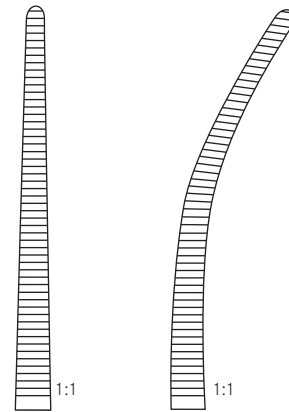

Präparier- und Ligaturklemmen
Dissecting and ligature forceps

Pinces à disséquer et à sutures
Pinzas para preparación y suturas
Pinze per preparazioni e suture



MIXTER

155 mm – 6"	tk 12300-15
190 mm – 7½"	tk 12300-19

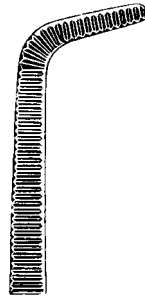

KANTROWITZ

190 mm – 7½"	tk 12303-19
240 mm – 9½"	tk 12303-24
265 mm – 10½"	tk 12303-26

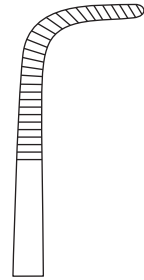

MIXTER

220 mm – 8¾"	tk 12305-22
350 mm – 14"	tk 12305-35

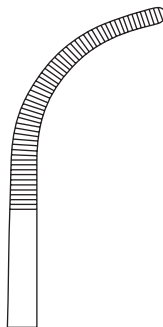

1:2

Präparier- und Ligaturklemmen
Dissecting and ligature forceps

Pinces à disséquer et à sutures
Pinzas para preparación y suturas
Pinze per preparazioni e suture

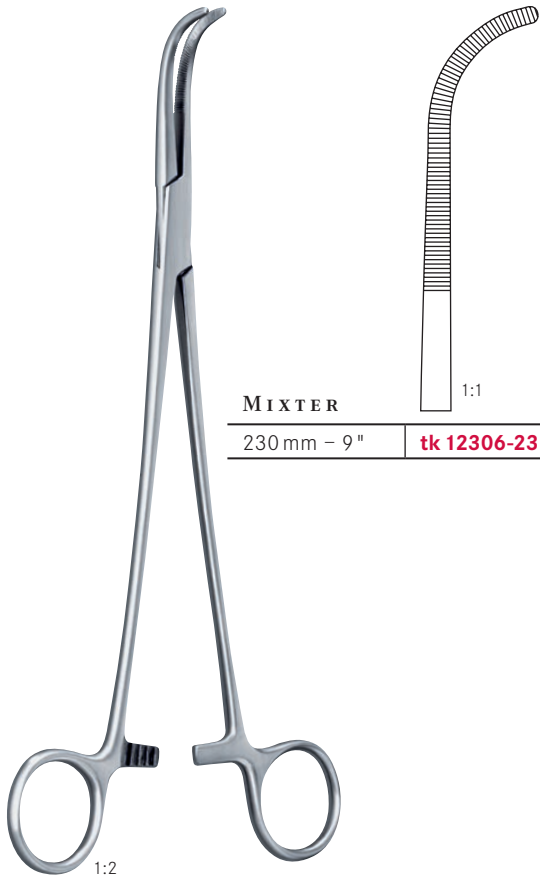

MIXTER
230 mm – 9" **tk 12306-23**

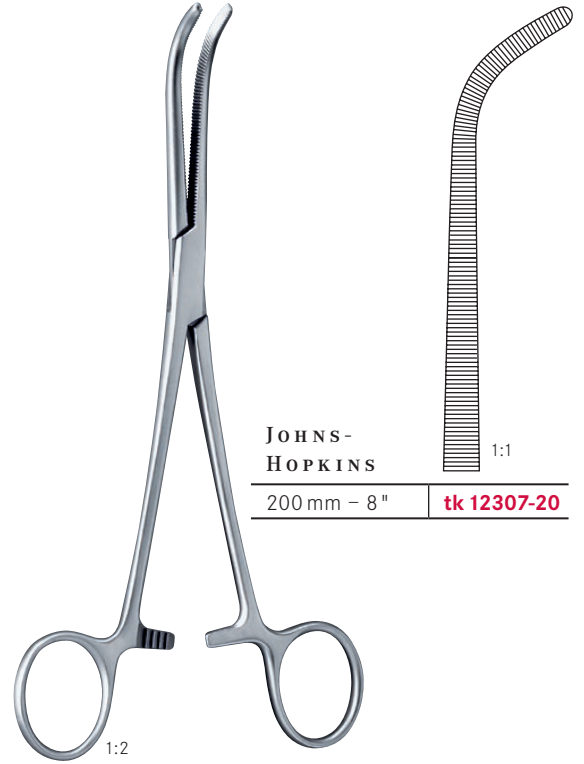

JOHNS-HOPKINS
200 mm – 8" **tk 12307-20**



MIXTER-O'SHAUGNESSY
190 mm – 7½" **tk 12308-19**

Präparier- und Ligaturklemmen
Dissecting and ligature forceps

Pinces à disséquer et à sutures
Pinzas para preparación y suturas
 Pinze per preparazioni e suture

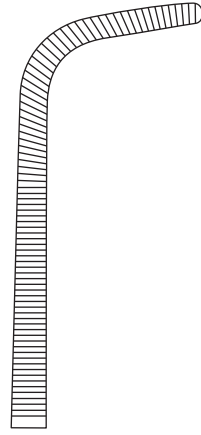

WICKSTRÖM

210 mm – 8 1/4 "	tk 12317-21
240 mm – 9 1/2 "	tk 12317-24

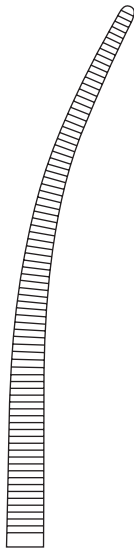

CRAFOORD

180 mm – 7 "	tk 12321-18
240 mm – 9 1/2 "	tk 12321-24

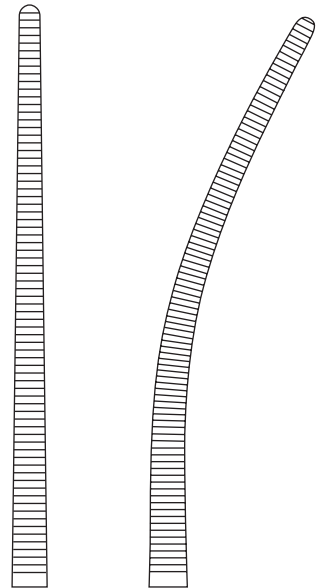

SAROT

240 mm – 9 1/2 "	tk 12318-24	tk 12319-24
350 mm – 14 "	tk 12318-35	tk 12319-35

Präparier- und Ligaturklemmen
Dissecting and ligature forceps

Pinces à disséquer et à sutures
Pinzas para preparación y suturas
Pinze per preparazioni e suture

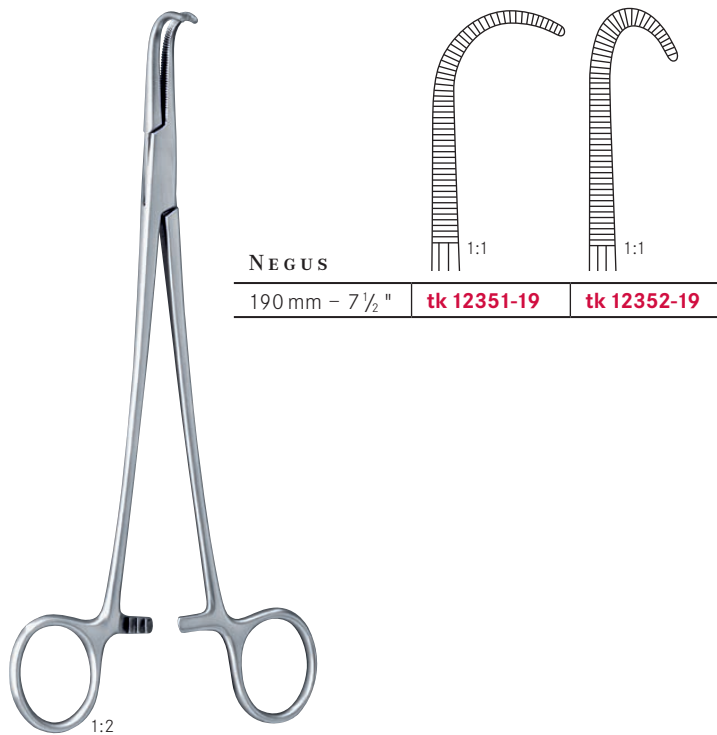

Gallenkanal- und Nierenstielklemmen
Kidney pedicle and gall duct forceps

Pinces pour pédicules renaux et voies biliaires
Pinzas para pediculos renales y conductos biliares
 Pinze per peduncoli renali e vie biliari



LOWER
 180 mm – 7" **tk 12311-18**

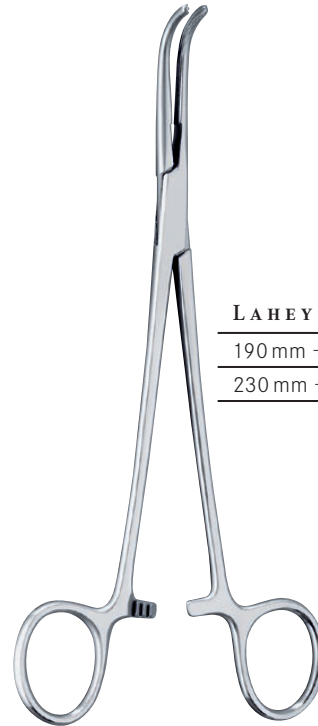
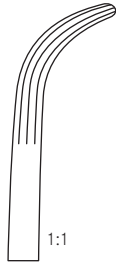

LAHEY
 190 mm – 7½" **tk 12310-19**
 230 mm – 9" **tk 12310-23**

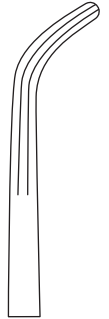

**MC QUIGG-
 MIXTER**
 220 mm – 8¾" **tk 12309-22**

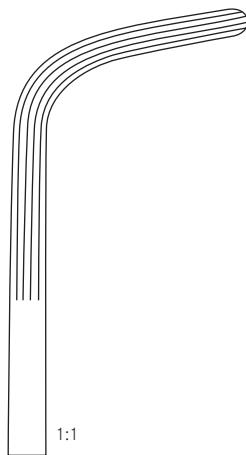

Gallenkanal- und Nierenstielklemmen
Kidney pedicle and gall duct forceps

Pinces pour pédicules renaux et voies biliaires
Pinzas para pediculos renales y conductos biliares
Pinze per peduncoli renali e vie biliari



FINOCHIETTO

240 mm – 9 1/2 " tk 12312-24

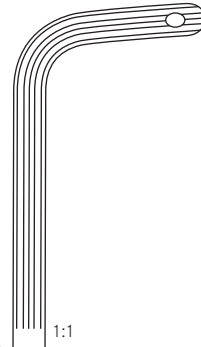

1:1

1:2



MIXTER

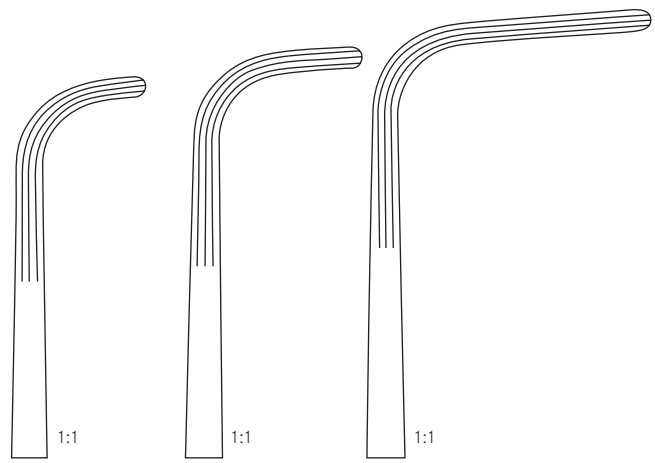

1:1

1:1

1:1

220 mm – 8 3/4 "

250 mm – 9 3/4 "

280 mm – 11 "

tk 12313-22

tk 12315-25

tk 12315-28

1:2

Gallenkanal- und Nierenstielklemmen
Kidney pedicle and gall duct forceps

Pinces pour pédicules renaux et voies biliaires
Pinzas para pediculos renales y conductos biliares
Pinze per peduncoli renali e vie biliari



GUYON		1:1	1:1	1:1	1:1	1:1
200 mm – 8"	220 mm – 8 3/4"	240 mm – 9 1/2"	230 mm – 9"	230 mm – 9"		
tk 12360-20	tk 12360-22	tk 12360-24	tk 22017-23	tk 22019-23		

ATRAUMIK



GRAY				1:1	1:1	1:1	1:1
Fig. 1	Fig. 2	Fig. 1	Fig. 2				
220 mm – 8 3/4"	230 mm – 9"	220 mm – 8 3/4"	230 mm – 9"				
tk 12371-22	tk 12372-23	tk 12373-22	tk 12374-23				
		1x2	1x2				

Nierenstielklemmen
Kidney pedicle forceps

Pinces pour pédicules renaux
Pinzas para pediculos renales
Pinze per peduncoli renali



1:2

HERRICK

1:1

230 mm – 9 "

tk 12356-23

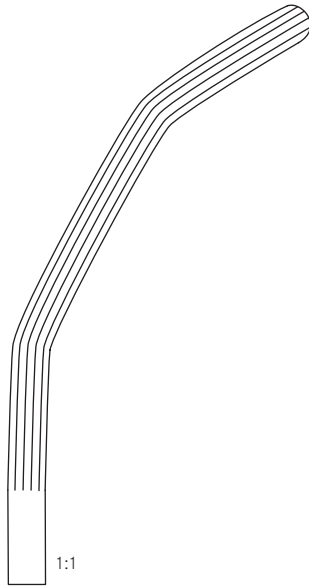

1:2

GUYON

1:1

230 mm – 9 "

tk 12357-23

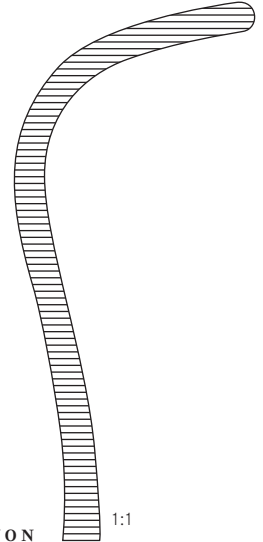

1:2

MAYO-
GUYON

1:1

230 mm – 9 "

tk 12375-23

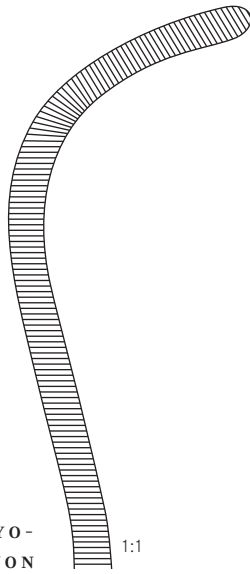

Klemmzangen – Peritoneumklemmen
 Clamp forceps – Peritoneal forceps

Pinces-clamps – Pincés pour le péritoine
 Pinzas-clamps – Pinzas para peritoneo
 Pinze per peritoneo

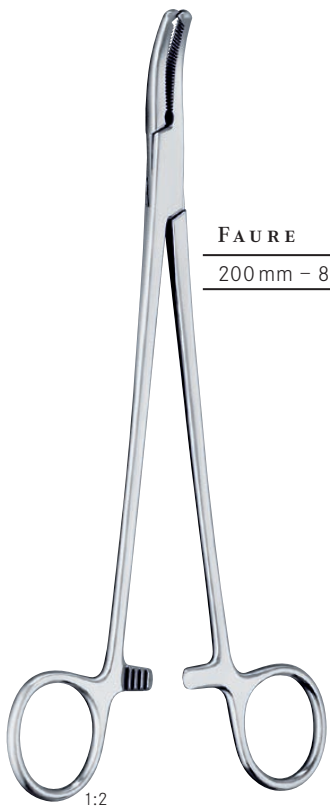

FAURE
 200 mm – 8" **tk 12415-20**
 1x2



1:1

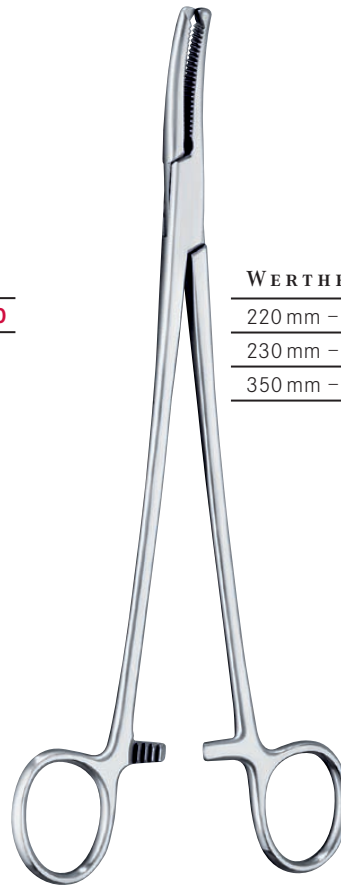

WERTHEIM
 220 mm – 8 3/4" **tk 12410-22**
 230 mm – 9" **tk 12410-23**
 350 mm – 14 1/2" **tk 12410-35**
 1x2

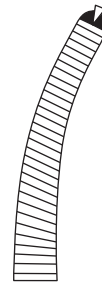

1x2

Klemmzangen – Peritoneumklemmen
Clamp forceps – Peritoneal forceps

Pinces-clamps – Pinces pour le péritoine
Pinzas-clamps – Pinzas para peritoneo
Pinze per peritoneo



PHANEUF

215 mm – 8 1/2 "



1:1

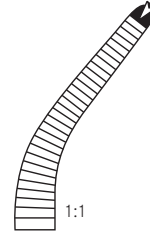

1:1

1x2

1x2

1:2



MOYNIHAN

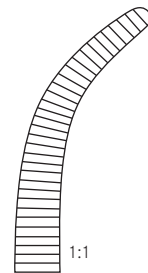

1:1

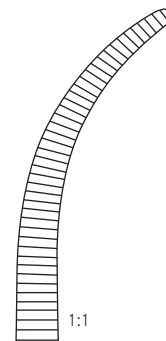

1:1

230 mm – 9 "

240 mm – 9 1/2 "

tk 12423-23

tk 12424-24

Klemmzangen – Peritoneumklemmen
 Clamp forceps – Peritoneal forceps

Pinces-clamps – Pince pour le péritoine
 Pinzas-clamps – Pinzas para peritoneo
 Pinze per peritoneo



BABY-
 MIKULICZ

140 mm – 4 1/2 "



1:1

1x2

tk 12426-14



MIKULICZ

200 mm – 8 "

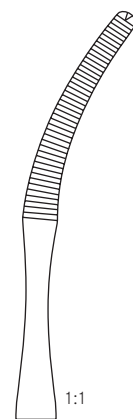

1:1

1x2

tk 12427-20

Klemmzangen - Peritoneumklemmen
Clamp forceps - Peritoneal forceps

Pinces-clamps - Pinces pour le péritoine
Pinzas-clamps - Pinzas para peritoneo
Pinze per peritoneo



MAINGOT

205 mm - 8"	tk 12433-20
250 mm - 9 3/4"	tk 12433-25

1x2

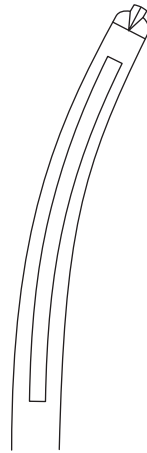

WERTHEIM

250 mm - 9 3/4"	tk 12432-25
-----------------	-------------

1:2

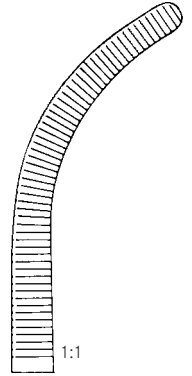

WERTHEIM-
CULLEN

215 mm - 8 1/2"	tk 12440-21
-----------------	-------------

1:2

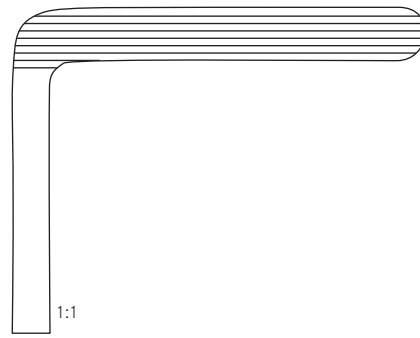

Hysterektomieklemmen
Hysterectomy forceps

Pinces pour hystérectomie
Pinzas para histerectomia
Pinze per isterectomia

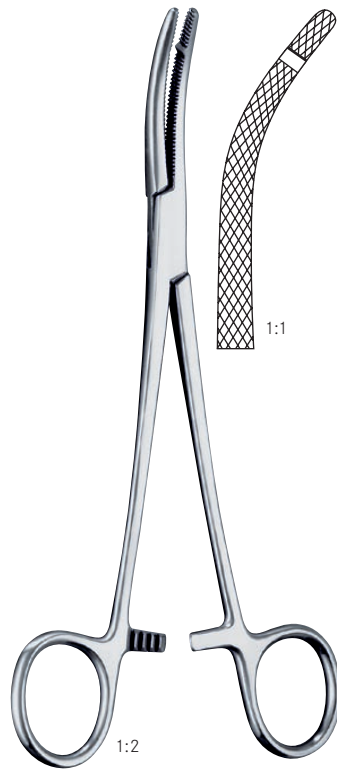

HEANEY

210 mm – 8 1/4"

tk 12435-21

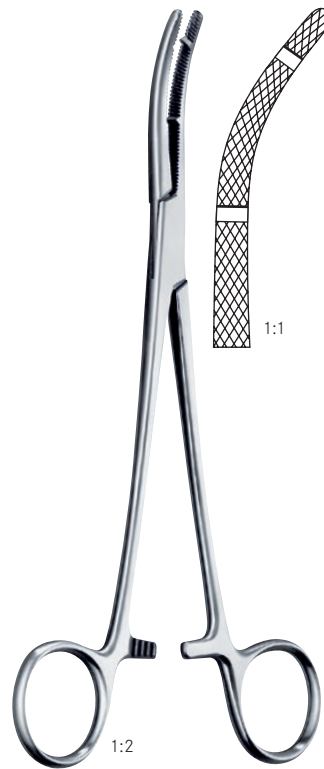

tk 12436-21

Hysterektomieklemmen
Hysterectomy forceps

Pinces pour hystérectomie
Pinzas para histerectomia
Pinze per isterectomia



HEANEY-
BALLANTINE

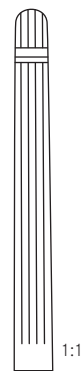

1:1

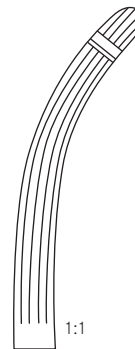

1:1

210 mm – 8 1/4"

tk 12438-21

tk 12439-21

Parametriumklemmen
Parametrium forceps

Pincas parametrium
Pinzas parametrium
Pinze parametrium

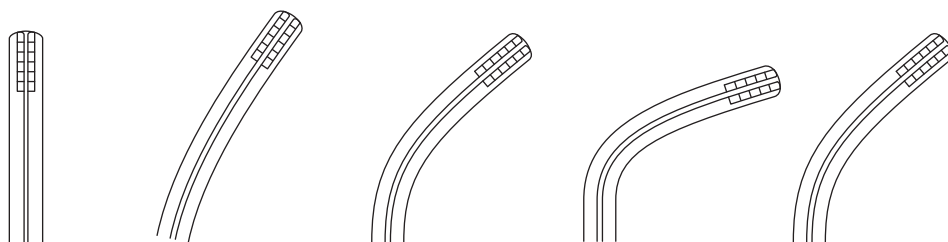
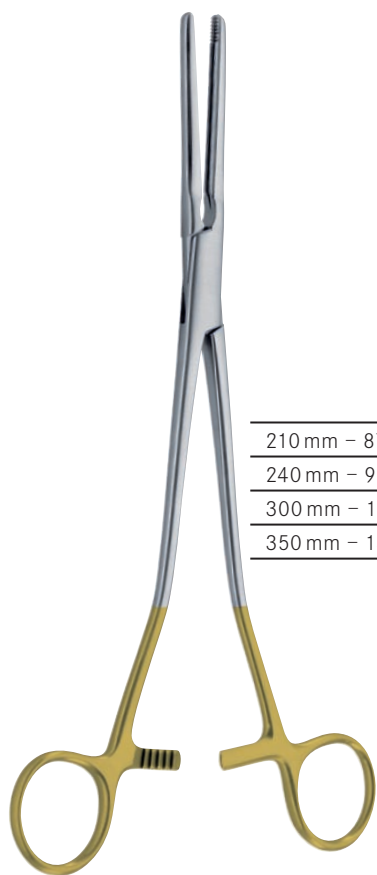

210 mm – 8 1/4"	tk 34155-21	tk 34156-21	tk 34157-21	tk 34158-21	tk 34159-21
240 mm – 9 1/2"	tk 34155-24	tk 34156-24	tk 34157-24	tk 34158-24	tk 34159-24
300 mm – 12"	tk 34155-30	tk 34156-30	tk 34157-30	tk 34158-30	tk 34159-30
350 mm – 13 3/4"	tk 34155-35	tk 34156-35	tk 34157-35	tk 34158-35	tk 34159-35

S-förmig gebogen
S-curved
coube en S
curva en S
curva a forma di S

Lungenfazzangen
Lung grasping forceps

Pinces-clamps pour poumons
Pinzas para coger pulmones
Pinza per afferrare il polmone

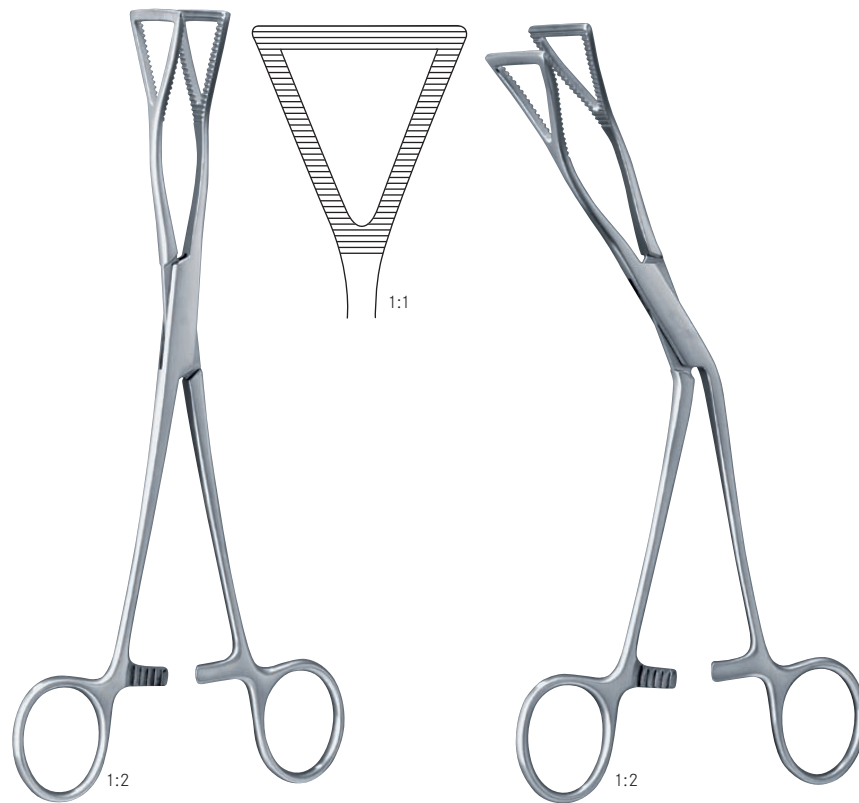

LOVELACE

200 mm – 8"

tk 12495-20

tk 12496-20

Bronchus- und Gefäßklemmen
Bronches- and vascular clamps

Pinces vasculaires et pour bronches
Pinzas vasculares y bronquiales
 Pinze vascolari e per bronchi



PRICE-
 THOMAS

220 mm – 8 3/4" **tk 12500-22**

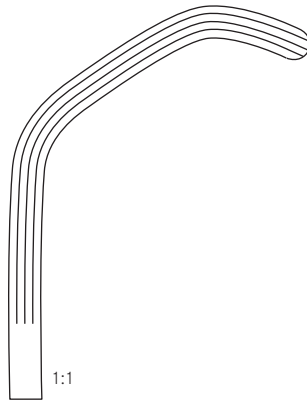

PRICE-
 THOMAS

220 mm – 8 3/4" **tk 12502-01**

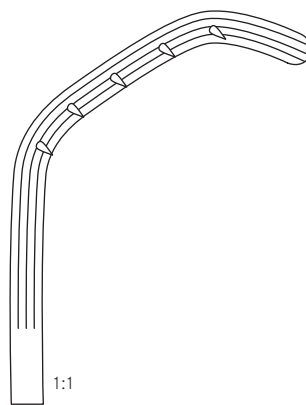

Stifte links
Pins left
 Goupilles à gauche
Pernos izquierda
 Perni a sinistra

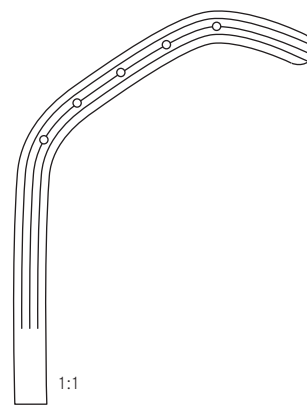

Stifte rechts
Pins right
 Goupilles à droit
Pernos derecha
 Perni a destra

Bronchus- und Gefäßklemmen
Bronches- and vascular clamps

Pinces vasculaires et pour bronches
Pinza clamps vasculares y bronquiales
 Pinze vascolari e per bronchi



SAROT

230 mm – 9"

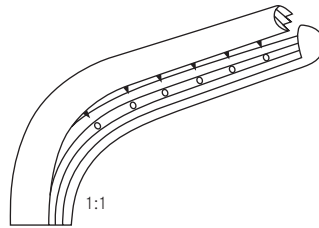

tk 12503-23

Stifte links
Pins left

Goupilles à gauche
Pernos izquierda
 Perni a sinistra

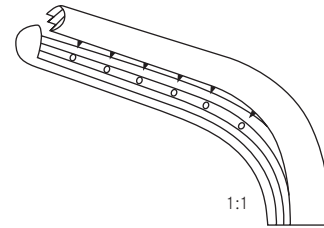

tk 12504-23

Stifte rechts
Pins right

Goupilles à droit
Pernos derecha
 Perni a destra

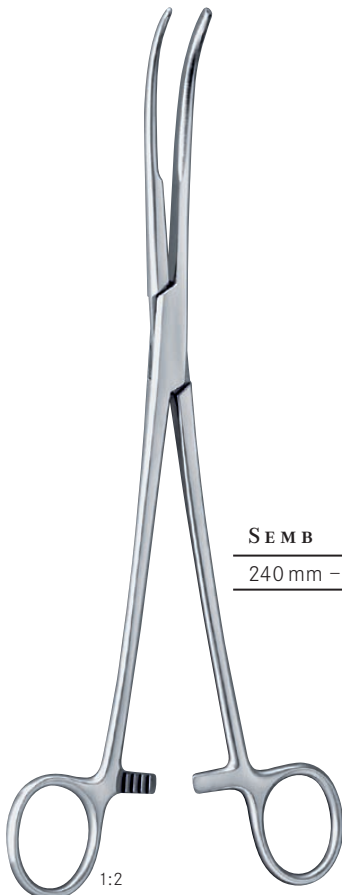

SEMB

240 mm – 9 1/2"



tk 12505-24



tk 12510-24

Bronchus- und Gefäßklemmen
 Bronches- and vascular clamps

Pinces vasculaires et pour bronches
 Pinzas vasculares y bronquiales
 Pinze vascolari e per bronchi



BABY-SATINSKY

150 mm – 6"

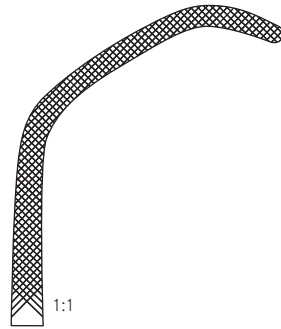

1:1

tk 12545-15

1:2



SATINSKY

265 mm – 10 1/2"

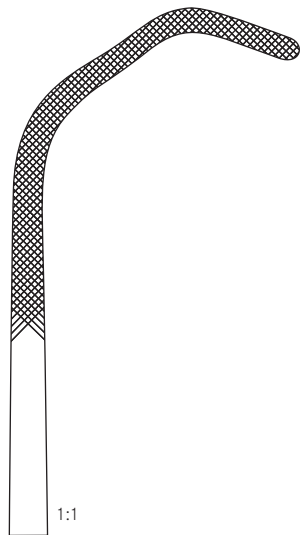

1:1

Fig. 1
 tk 12550-01

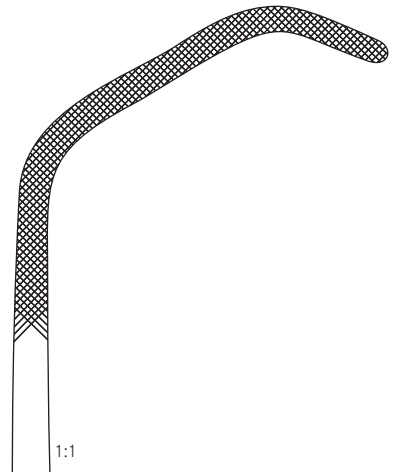

1:1

Fig. 2
 tk 12551-01

Fig. 2
 tk 12550-02

S-förmig gebogen
 S-curved
 courbe en S
 curva en S
 curva a forma di S

S-förmig gebogen
 S-curved
 courbe en S
 curva en S
 curva a forma di S

1:2

Tuchklemmen
Towel forceps

Pinces à champs
Pinzas de campo
Pinze fissateli



BERNHARD

100 mm – 4 "	tk 12800-10
120 mm – 4 ¾ "	tk 12800-12
140 mm – 5 ½ "	tk 12800-14
165 mm – 6 ½ "	tk 12800-16
180 mm – 7 "	tk 12800-18



BACKHAUS

90 mm – 3 ½ "	tk 12805-09
110 mm – 4 ¼ "	tk 12805-11
130 mm – 5 "	tk 12805-13
150 mm – 6 "	tk 12805-15



ROEDER

130 mm – 5 "	tk 12802-13
150 mm – 6 "	tk 12802-15



110 mm – 4 " **tk 12807-11**

mit Schlauchhalter
with clip for tube
avec porte-tuyeau
con soporte de tubo
con supporto per tubo

Tuchklemmen
Towel forceps

Pinces à champs
Pinzas de campo
Pinze fissateli



ROBIN

135 mm – 5 1/4" tk 12809-13

mit Schlauchhalter bis 5 mm Ø
with clip for tube up to 5 mm Ø
avec porte-tuyeau à 5 mm Ø
con soporte de tubo hasta 5 mm Ø
con supporto per tubo fino a 5 mm Ø



JONES

50 mm – 2" tk 12810-05
90 mm – 3 1/2" tk 12810-09



SCHAEDEL

90 mm – 3 1/2" tk 12820-09



DOYEN

180 mm – 7" tk 12825-18

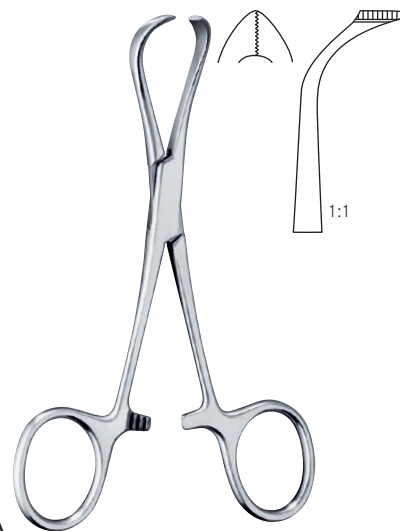

LORNA

100 mm – 4" tk 12830-10
130 mm – 5" tk 12830-13

Tuchklemmen
Towel forceps

Pinces à champs
Pinzas de campo
Pinze fissateli



LANE

130 mm – 5 "	tk 12840-13
150 mm – 6 "	tk 12840-15
200 mm – 8 "	tk 12840-20

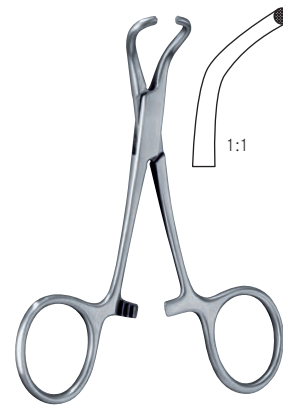

TOHOKU-JAPAN

100 mm – 4 "	tk 12845-10
130 mm – 5 "	tk 12845-13



PEERS-BERTRAM

145 mm – 5 ¾ "	tk 12847-14
----------------	--------------------



115 mm – 4 ½ "	tk 12850-11
140 mm – 5 ½ "	tk 12850-13

für Papierabdeckung
for paper clothes

pour couvertures en papier
para paños de papel
per copertura di carta

Schlauchklemmen
Tubing clamps

Presse-tubes
Pinzas para tubos
Pinze serratubi



150 mm – 6 "	tk 14100-15
160 mm – 6¼ "	tk 14100-16
190 mm – 7½ "	tk 14100-19
240 mm – 9½ "	tk 14100-24

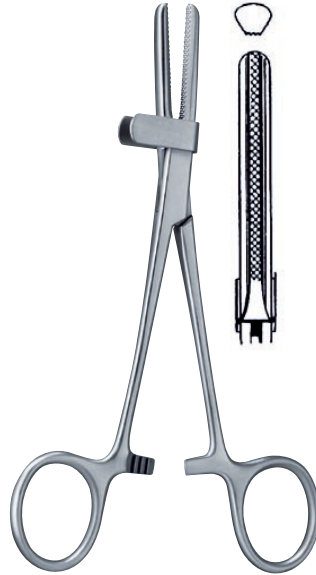

150 mm – 6 "	tk 14101-15
160 mm – 6¼ "	tk 14101-16
190 mm – 7½ "	tk 14101-19

mit Schutzbügel
with protection
avec protection
con protector
con protettore

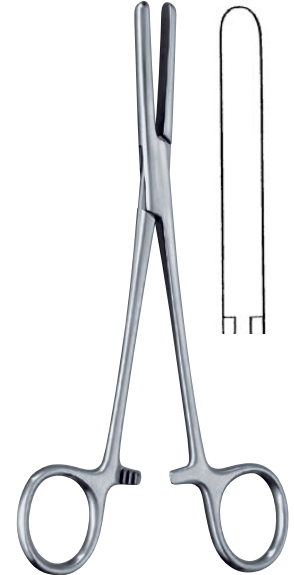

165 mm – 6½ "	tk 14110-16
180 mm – 7 "	tk 14110-18



KLINIKUM-
BERLIN

145 mm – 5¾ "	tk 14120-14	tk 14114-14
---------------	--------------------	--------------------

mit extra langer Sperre
with extra long ratchet
avec crémaillère extra longue
con cremallera extra larga
con cremagliera extra lunga



GUNNAR

185 mm – 7¼ "	tk 14160-18
---------------	--------------------

