



ENDOSCOPY
GYNAECOLOGY



Gynäkologie	Gynécologie
Gynaecology	Ginecología
	Ginecologia

Kataloge
Catalogues

Catalogues
Catálogos
Cataloghi

Endoskopie
Endoscopy

Endoscopia
Endoscopia
Endoscopia



Geräte
Units
Appareils
Equipos
Apparecchi

ENDOSCOPY No. **205**



Sinuskopie
Sinuscopy
Sinuscopie
Sinuscopia
Sinuscopia

ENDOSCOPY No. **211**



Optiken
Scopes
Optiques
Ópticas
Ottiche

ENDOSCOPY No. **206**



Mini & Mikro System für MIC
Mini & micro system for MIS
Système mini & mikro pour MIC
Sistema mini y micro para MIC
Sistema mini e micro per MIC

ENDOSCOPY No. **213**



Laparoskopie
Laparoscopy
Laparoscopie
Laparoscopia
Laparoscopia

ENDOSCOPY No. **207**



System zur lumbalen Diskektomie
Lumbar discectomy system
Système pour la discectomie lombaire
Sistema para la discectomia lumbar
Sistema per la discectomia lombare

ENDOSCOPY No. **601**



Urologie
Urology
Urologie
Urología
Urologia

ENDOSCOPY No. **208**

Sterilisation
Sterilization

Stérilisation
Esterilización
Sterilizzazione



Gynäkologie
Gynaecology
Gynécologie
Ginecología
Ginecologia

ENDOSCOPY No. **209**



Steril Container - System I
Sterile container - system I
Contenaires pour stérilisation - système I
Contenedores para esterilización - sistema I
Container per sterilizzazione - sistema I

STERILIZATION No. **302**



Arthroskopie
Arthroscopy
Arthroscopie
Artroscopia
Artroscopia

ENDOSCOPY No. **210**



Steril Container - System II
Sterile container - system II
Contenaires pour stérilisation - système II
Contenedores para esterilización - sistema II
Container per sterilizzazione - sistema II

STERILIZATION No. **303**

Kataloge | Catalogues
 Catalogues | Catálogos
 Cataloghi

Chirurgie | Chirurgie
 Surgery | Cirugía
 Chirurgia



Hauptkatalog Chirurgie
Main catalogue surgery
 Catalogue général
Catálogo general
 Catalogo generale
SURGERY No. **111**



Aneurysmen Clips
Aneurysm clips
 Clips pour anévrismes
Clips para aneurismas
 Clips per aneurismi
SURGERY No. **134**



Plastische Chirurgie
Plastic surgery
 Chirurgie plastique
Cirugía plástica
 Chirurgia plastica
SURGERY No. **112**



HNO Hauptkatalog
ENT main catalogue
 ORL catalogue général
ORL catálogo general
 ORL catalogo generale
ENT No. **501**



Ophthalmologie
Ophthalmology
 Ophthalmologie
Oftalmología
 Oftalmologia
SURGERY No. **113**

Elektro Chirurgie | Eléctrochirurgie
 Electro surgery | Electro-Cirugía
 Elettrobisturi



Traumatologie
Traumatology
 Traumatologie
Traumatología
 Traumatologia
SURGERY No. **114**



Elektro Chirurgie
Electro surgery
 Eléctrochirurgie
Electro-Cirugía
 Elettrobisturi
ELECTRO SURGERY No. **212**



Gefäßschirurgie
Vascular surgery
 Chirurgie vasculaire
Cirugía vascular
 Chirurgia vascolare
SURGERY No. **115**

Dental | Dentaire
 Dental | Dental
 Dentale



Retraktor Systeme
Retractor systems
 Systèmes des écarteurs
Sistema de retractores
 Sistemi di retrattori
SURGERY No. **133**

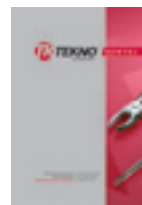

Dental
 Dental
 Dentaire
 Dental
 Dentale
DENTAL No. **402**

Inhalt | **Contenu**
Content | **Indice**
Indice

	<p>Symbole und Besonderheiten, Hysteroskopie <i>Symbols and characteristics, Hysteroscopy</i> Symboles et caractéristiques, Hysteroscopie <i>Símbolos y características, Histeroscopia</i> Simboli e caratteristiche, Isteroscopia</p>	<p>7</p>	
	<p>Hysteroskop System für 2,0 mm Optiken <i>Hysteroscope system for 2.0mm scopes</i> Système d'hysteroscopie pour optiques de 2.0 mm <i>Sistema de histeroscopia para opticas de 2.0 mm</i> Sistema d'isteroscopia per ottiche di 2.0 mm</p>		<p>8 - 10</p>
	<p>Hysteroskop System für 2,7 mm Optiken <i>Hysteroscope system for 2.7mm scopes</i> Système d'hysteroscopie pour optiques de 2.7 mm <i>Sistema de histeroscopia para opticas de 2.7 mm</i> Sistema d'isteroscopia per ottiche di 2.7 mm</p>		<p>11 - 16</p>
	<p>Hysteroskop System für 4,0 mm Optiken <i>Hysteroscope system for 4.0mm scopes</i> Système d'hysteroscopie pour optiques de 4.0 mm <i>Sistema de histeroscopia para opticas de 4.0 mm</i> Sistema d'isteroscopia per ottiche di 4.0 mm</p>		<p>17 - 22</p>
	<p>Flexible Instrumente <i>Flexible instruments</i> Instruments flexibles <i>Instrumentos flexibles</i> Strumenti flessibili</p>		<p>23 - 26</p>
	<p>Symbole und Besonderheiten, Resektoskopie <i>Symbols and characteristics, Resectoscopy</i> Symboles et caractéristiques, Résectoscopie <i>Símbolos y características, Resectoscopia</i> Simboli e caratteristiche, Resettoscopia</p>		<p>27 - 29</p>
	<p>Resektoskopie, monopolar <i>Resectoscopy, monopolar</i> Résectoscopie, monopolaire <i>Resectoscopia, monopolar</i> Resettoscopia, monopolare</p>		<p>30 - 37</p>

Inhalt | Contenu
 Content | Indice
 Indice

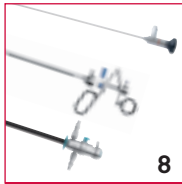

8

Resektoskopie, bipolar
Resectoscopy, bipolar
 Résectoscopie, bipolaire
Resectoscopia, bipolar
 Resettoscopia, bipolare

38 - 48



9

OP-Laparoskope
OP-Laparoscopes
 OP-Laparoscopes
OP-Laparoscopios
 Laparoscopi operativi

49



10

Ring Applikatoren
Ring applicators
 Appicateurs des anneaux
Appicadores de anillos
 Applicatore per anelli

50



11

Uterusmanipulator
Uterus manipulator
 Manipulator uterin
Manipulador uterino
 Manipolatore uterino

51

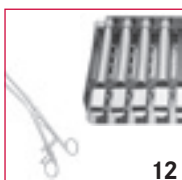

12

Instrumente
Instruments
 Instruments
Instrumentos
 Strumenti

52 - 61



13

Zubehör
Accessories
 Accessoires
Accesorios
 Accessori

62 - 65

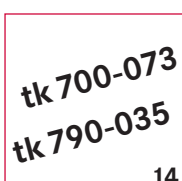

14

Nummernverzeichnis
Numerical index
 Index numérique
Indice numerico
 Indice dei numero d'articolo

67 - 68



Bitte fordern Sie unseren Spezialkatalog an.
Please ask for our special catalogue.

*Veuillez demander pour notre catalogue spécial.
Por favor preguntan para el catálogo especial.*

Per favore domandate per il nostro catalogo speciale.

Symbole und Besonderheiten
Symbols and characteristics

Symboles et caractéristiques
Símbolos y características
Simboli e caratteristiche

Farberkennung Hysteroskopie
Colour code, hysteroscopy

Marquage en couleur, hysteroscopie
Identificación de color, histeroscopia
Codice colori, isteroscopia

2.0 mm	
2.7 mm	
4.0 mm	

für Optik
for scope

pour optique
para óptica
per ottica

Auch mit Plastikhähnen lieferbar
Also available with plastic stopcocks

Aussi disponible avec robinets en plastique
También disponible con llaves en plastica
Anche disponibili con rubinetto in plastica

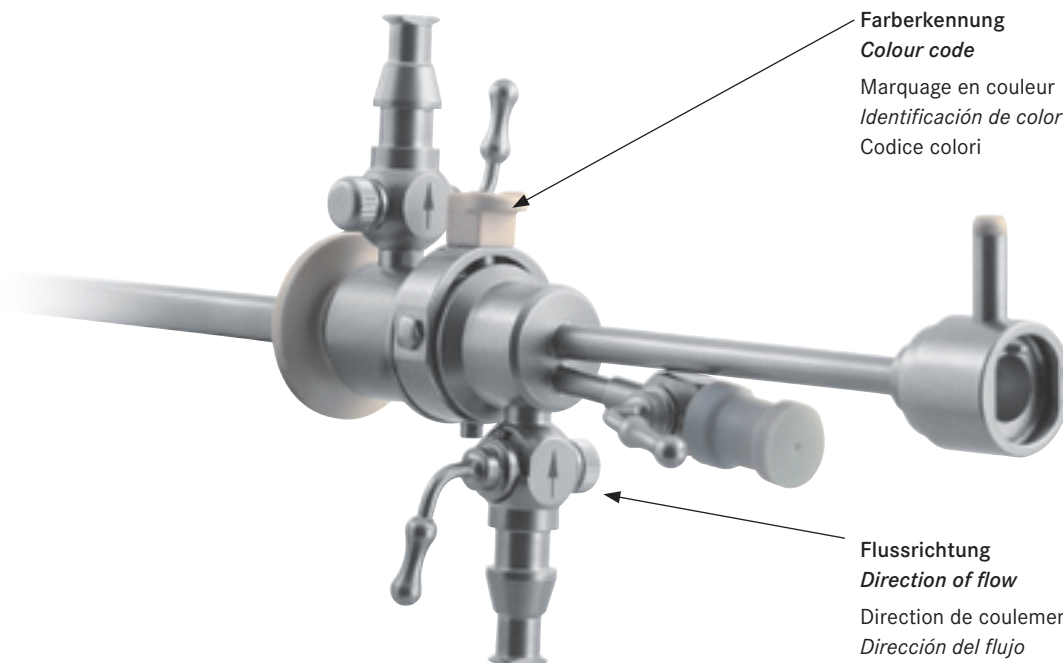
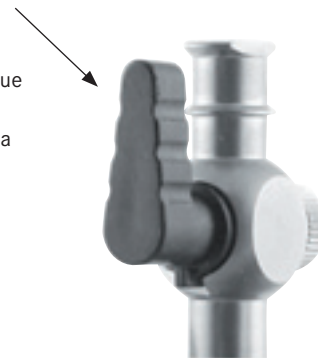

Farberkennung
Colour code
Marquage en couleur
Identificación de color
Codice colori

Flussrichtung
Direction of flow
Direction de coulement
Dirección del flujo
Direzione del flusso

Schaftform
Shape of sheath
Forme de la gaine
Forma de la vaina
Forma della camicia



Oval
Oval
Oval
Oval
Ovale



Tropfenförmig
Triangular
Triangulaire
Triangular
A forma di goccia



Halbrund
Semi circular
Demi-circulaire
Semi circular
Semicircolare



Rund
Round
Ronde
Redondo
Rotondo



Diagnostikschäfte und Hysteroskope
Diagnostic sheaths and hysteroscopes

Gaines pour diagnose et hysteroscopes
Vainas para exploración y hysteroscopios
Camicie diagnostiche e isteroscopi

autoklavierbar / autoclavable
134°C / 273°F - 18 min.

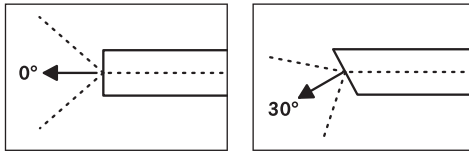

Ø 2.0 mm - 260 mm	tk 700-220	tk 700-221
-------------------	-------------------	-------------------

Ø, Arbeitslänge
Ø, Working length
Ø, Longueur de travail
Ø, Longitud de trabajo
Ø, Lunghezza operativa



0°	Ø 2.6 mm - 235 mm	tk 791-250
30°	Ø 2.6 mm - 235 mm	tk 791-251

für Optik <i>for scope</i>	Schaft - Arbeitslänge <i>Sheath - Working length</i>
pour optique <i>para óptica</i>	Gaine - Longueur du travail <i>Vaina - Longitud de trabajo</i>
per ottica	Camicia - Lunghezza operativa



tk 791-258

Obturator für tk 791-250 und tk 791-251
Obturator for tk 791-250 and tk 791-251
Obturateur pour tk 791-250 et tk 791-251
Obturator para tk 791-250 y tk 791-251
Otturatore per tk 791-250 e tk 791-251



Diagnostikschäfte
Diagnostic sheaths

Gaines pour diagnose
Vainas para exploración
Camicie diagnostiche



0°	tk 791-050
30°	tk 791-051

für Optik <i>for scope</i>	Innenschaft <i>Inner sheath</i>
pour optique <i>para óptica</i>	Gaine intérieur <i>Vaina interior</i>
per ottica	Camicia interna

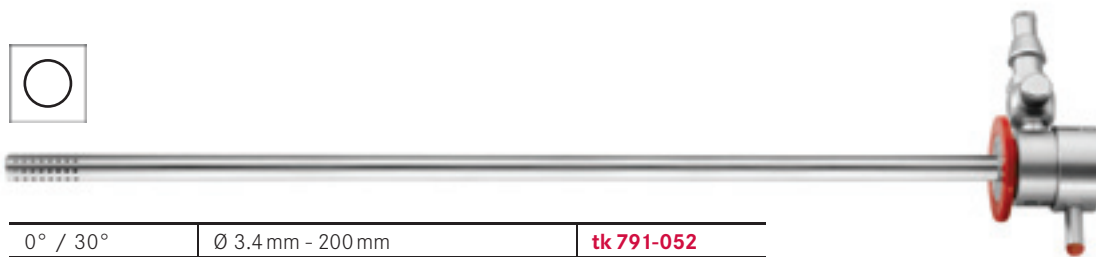

0° / 30°	Ø 3.4 mm - 200 mm	tk 791-052
----------	-------------------	-------------------

für Optik <i>for scope</i>	Außenschaft zur Dauerspülung - Arbeitslänge <i>Outer sheath for continuous flow - Working length</i>
pour optique <i>para óptica</i>	Gaine extérieure à irrigation permanente - Longueur du travail <i>Vaina exterior para irrigación continua - Longitud de trabajo</i>
per ottica	Camicia esterna a flusso continuo - Lunghezza operativa



tk 791-053

Obturator für tk 791-050 und tk 791-051
Obturator for tk 791-050 and tk 791-051
Obturateur pour tk 791-050 et tk 791-051
Obturator para tk 791-050 y tk 791-051
Otturatore per tk 791-050 e tk 791-051



Operations-Dauerspülschäfte
Continuous flow operating sheaths

Gaines avec irrigation permanente
Vainas con irrigación y succión continua
Camicie a flusso continuo

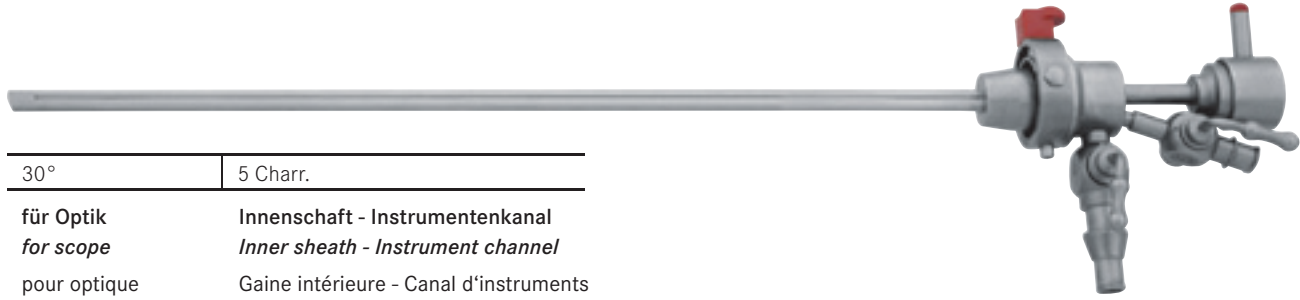

30°	5 Charr.
-----	----------

für Optik
for scope

Innenschaft - Instrumentenkanal
Inner sheath - Instrument channel

pour optique
para óptica
per ottica

Gaine intérieure - Canal d'instruments
Vaina interior - Canal para instrumentos
Camicia interna - Canale operativa



30°	Ø 4.3 mm - 190 mm
-----	-------------------

für Optik
for scope

Außenschaft zur Dauerspülung - Arbeitslänge
Outer sheath for continuous flow - Working length

pour optique
para óptica
per ottica

Gaine extérieure à irrigation permanente - Longueur du travail
Vaina exterior para irrigación continua - Longitud de trabajo
Camicia esterna a flusso continuo - Lunghezza operativa

tk 791-042

Komplett, Innen- und Außenschaft
Complete, inner and outer sheath

Complet, gaine intérieure et extérieure
Completo, vaina interior y exterior
Completo, camicia interna e esterna



Diagnostikschäfte und Hysteroskope
Diagnostic sheaths and hysteroscopes

Gaines pour diagnose et hysteroscopes
Vainas para exploración y hysteroscopios
Camicie diagnostiche e isteroscopi

autoklavierbar / autoclavable
134°C / 273°F - 18 min.

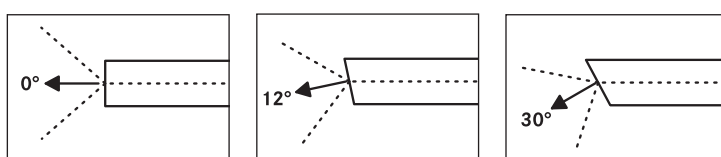

Ø 2.7 mm - 302 mm	tk 700-060	tk 700-062	tk 700-063
Ø 2.7 mm - 302 mm	tk 700-060SF	tk 700-062SF	tk 700-063SF

- Ø, Arbeitslänge
- Ø, Working length
- Ø, Longueur de travail
- Ø, Longitud de trabajo
- Ø, Lunghezza operativa

SF = Tekno-Flex
(see page 66)

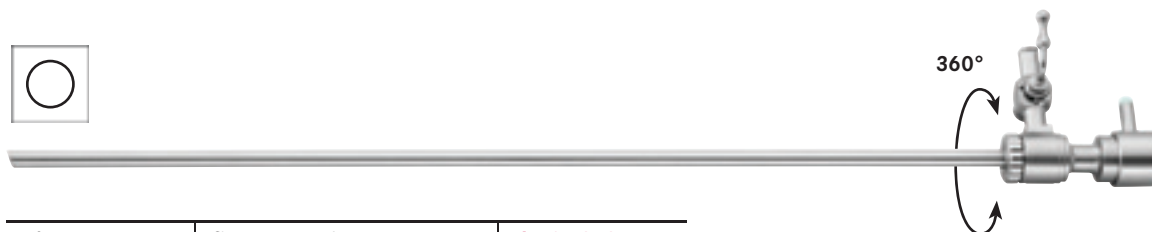

0°	Ø 3.7 mm - 267 mm	tk 791-252
30°	Ø 3.7 mm - 267 mm	tk 791-253

- | | |
|------------------------------------|---|
| für Optik
<i>for scope</i> | Schaft - Arbeitslänge
<i>Sheath - Working length</i> |
| pour optique
<i>para óptica</i> | Gaine - Longueur du travail
<i>Vaina - Longitud de trabajo</i> |
| per ottica | Camicia - Lunghezza operativa |

tk 791-257

Obturator für tk 791-252 und tk 791-253
Obturator for tk 791-252 and tk 791-253
Obturateur pour tk 791-252 et tk 791-253
Obturator para tk 791-252 y tk 791-253
Otturatore per tk 791-252 e tk 791-253



Diagnostikschäfte
Diagnostic sheaths

Gaines pour diagnose
Vainas para exploración
Camicie diagnostiche



0°	tk 791-031
30°	tk 791-030

für Optik <i>for scope</i>	Innenschaft <i>Inner sheath</i>
pour optique <i>para óptica</i> per ottica	Gaine intérieure <i>Vaina interior</i> Camicia interna

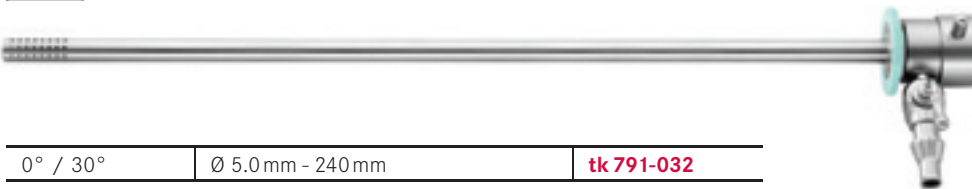

0° / 30°	Ø 5.0mm - 240mm	tk 791-032
----------	-----------------	-------------------

für Optik <i>for scope</i>	Außenschaft zur Dauerspülung - Arbeitslänge <i>Outer sheath for continuous flow - Working length</i>
pour optique <i>para óptica</i> per ottica	Gaine extérieure à irrigation permanente - Longueur du travail <i>Vaina exterior para irrigación continua - Longitud de trabajo</i> Camicia esterna a flusso continuo - Lunghezza operativa



tk 791-033

Obturator für tk 791-030 und tk 791-031
Obturator for tk 791-030 and tk 791-031
Obturateur pour tk 791-030 et tk 791-031
Obturator para tk 791-030 y tk 791-031
Otturatore per tk 791-030 e tk 791-031



Operations-Dauerspülschäfte
Continuous flow operating sheaths

Gaines avec irrigation permanente
Vainas con irrigación y succión continua
Camicie a flusso continuo



0°	Ø 6.0 mm - 200 mm	5 Charr.	tk 791-024
30°	Ø 6.0 mm - 200 mm	5 Charr.	tk 791-026

für Optik <i>for scope</i>	Schaft - Arbeitslänge <i>Sheath - Working length</i>	Instrumentenkanal <i>Instrument channel</i>
pour optique <i>para óptica</i> per ottica	Gaine - Longueur du travail <i>Vaina - Longitud de trabajo</i> Camicia - Lunghezza operativa	Canal d'instruments <i>Canal para instrumentos</i> Canale operativo



30°	5 Charr.	tk 791-080
-----	----------	-------------------

für Optik <i>for scope</i>	Instrumentenkanal <i>Instrument channel</i>	Innenschaft <i>Inner sheath</i>
pour optique <i>para óptica</i> per ottica	Canal d'instruments <i>Canal para instrumentos</i> Canale operativo	Gaine intérieure <i>Vaina interior</i> Camicia interna



30°	Ø 5.5 mm - 182 mm	tk 791-081
-----	-------------------	-------------------

für Optik <i>for scope</i>	Außenschaft zur Dauerspülung - Arbeitslänge <i>Outer sheath for continuous flow - Working length</i>
pour optique <i>para óptica</i> per ottica	Gaine extérieure à irrigation permanente - Longueur du travail <i>Vaina exterior para irrigación continua - Longitud de trabajo</i> Camicia esterna a flusso continuo - Lunghezza operativa



Operations-Dauerspülschäfte
Continuous flow operating sheaths

Gaines avec irrigation permanente
Vainas con irrigación y succión continua
Camicie a flusso continuo



30°	5 Charr.
-----	----------

für Optik <i>for scope</i>	Innenschaft - Instrumentenkanal <i>Inner sheath - Instrument channel</i>
pour optique <i>para óptica</i> per ottica	Gaine intérieure - Canal d'instruments <i>Vaina interior - Canal para instrumentos</i> Camicia interna - Canale operativa



30°	Ø 5.0 mm - 190 mm
-----	-------------------

für Optik <i>for scope</i>	Außenschaft zur Dauerspülung - Arbeitslänge <i>Outer sheath for continuous flow - Working length</i>
pour optique <i>para óptica</i> per ottica	Gaine extérieure à irrigation permanente - Longueur du travail <i>Vaina exterior para irrigación continua - Longitud de trabajo</i> Camicia esterna a flusso continuo - Lunghezza operativa

tk 791-041

Komplett, Innen- und Außenschaft
Complete, inner and outer sheath
Complet, gaine intérieure et extérieure
Completo, vaina interior y exterior
Completo, camicia interna e esterna



Operationsschäfte
Operating sheaths

Gaines d'operations
Vainas operativas
Camicia operativa

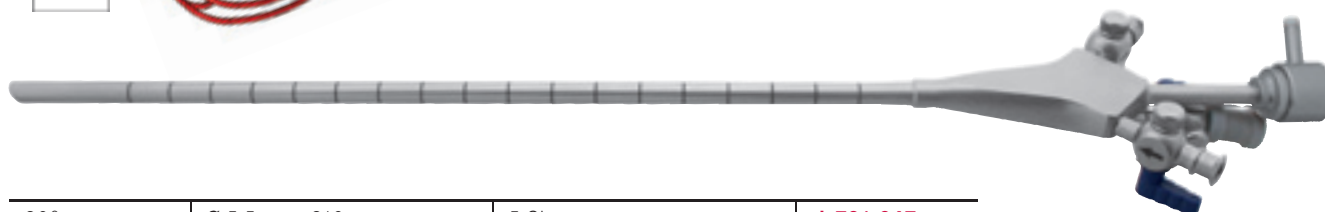
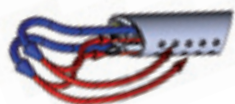

30°	Ø 5.5 mm - 210 mm	5 Charr.	tk 791-047
für Optik <i>for scope</i>	Schaft - Arbeitslänge <i>Sheath - Working length</i>	Instrumentenkanal <i>Instrument channel</i>	
pour optique <i>para óptica</i> per ottica	Gaine - Longueur du travail <i>Vaina - Longitud de trabajo</i> Camicia - Lunghezza operativa	Canal d'instruments <i>Canal para instrumentos</i> Canale operativo	



30°	Ø 5.6 x 4.0 mm - 248 mm	5 Charr.	tk 791-048
für Optik <i>for scope</i>	Schaft - Arbeitslänge <i>Sheath - Working length</i>	Instrumentenkanal <i>Instrument channel</i>	
pour optique <i>para óptica</i> per ottica	Gaine - Longueur du travail <i>Vaina - Longitud de trabajo</i> Camicia - Lunghezza operativa	Canal d'instruments <i>Canal para instrumentos</i> Canale operativo	



tk 791-049

Obturator für tk 791-048
Obturator for tk 791-048
Obturateur pour tk 791-048
Obturator para tk 791-048
Otturatore per tk 791-048



Operationsschäfte
Operating sheaths

Gaines d'operations
Vainas operativas
Camicia operativa

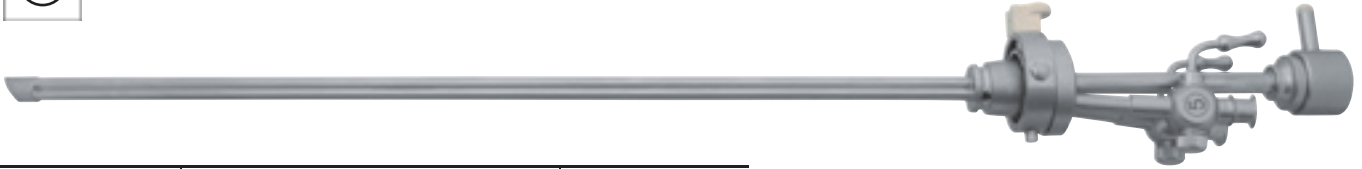

30°	5 Charr.	tk 791-045
-----	----------	-------------------

für Optik <i>for scope</i> pour optique <i>para óptica</i> per ottica	2 Instrumentenkanäle <i>2 Instrument channels</i> 2 Canaux d'instruments <i>2 Canales para instrumentos</i> 2 Canale operativi	Innenschaft <i>Inner sheath</i> Gaine intérieur <i>Vaina interior</i> Camicia interna
---	--	---



30°	Ø 6.5mm - 210mm	tk 791-046
-----	-----------------	-------------------

für Optik <i>for scope</i> pour optique <i>para óptica</i> per ottica	Außenschaft zur Dauerspülung - Arbeitslänge <i>Outer sheath for continuous flow - Working length</i> Gaine extérieure à irrigation permanente - Longueur du travail <i>Vaina exterior para irrigación continua - Longitud de trabajo</i> Camicia esterna a flusso continuo - Lunghezza operativa
---	--



Diagnostikschäfte und Hysteroskope
Diagnostic sheaths and hysteroscopes

Gaines pour diagnose et hysteroscopes
Vainas para exploración y hysteroscopios
Camicie diagnostiche e isteroscopi

autoklavierbar / autoclavable
134°C / 273°F - 18 min.

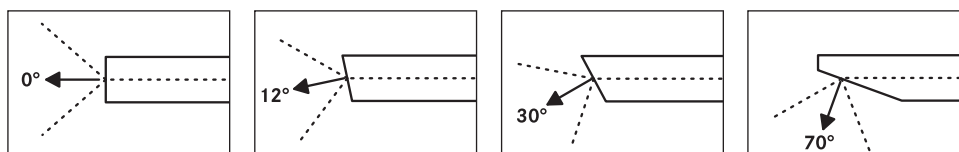

Ø 4.0 mm - 302 mm	tk 700-070	tk 700-072	tk 700-073	tk 700-077
Ø 4.0 mm - 302 mm	tk 700-070SF	tk 700-072SF	tk 700-073SF	tk 700-077SF

Ø, Arbeitslänge
Ø, Working length
Ø, Longueur de travail
Ø, Longitud de trabajo
Ø, Lunghezza operativa

SF = Tekno-Flex
(see page 66)

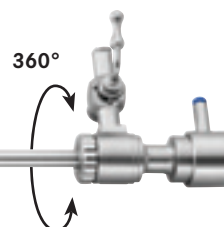

0°	Ø 5.0 mm - 267 mm	tk 791-131
30°	Ø 5.0 mm - 267 mm	tk 791-130

für Optik Schaft - Arbeitslänge
for scope *Sheath - Working length*
pour optique Gaine - Longueur du travail
para óptica *Vaina - Longitud de trabajo*
per ottica Camicia - Lunghezza operativa



tk 791-256

Obturator für tk 791-130 und tk 791-131
Obturator for tk 791-130 and tk 791-131
Obturateur pour tk 791-130 et tk 791-131
Obturator para tk 791-130 y tk 791-131
Otturatore per tk 791-130 e tk 791-131



Diagnostikschäfte
Diagnostic sheaths

Gaines pour diagnose
Vainas para exploración
Camicie diagnostiche



0° / 12°	tk 791-137
12° / 30°	tk 791-132

für Optik
for scope
pour optique
para óptica
per ottica

Innenschaft - Arbeitslänge
Inner sheath - Working length
Gaine intérieur - Longueur du travail
Vaina interior - Longitud de trabajo
Camicia interna - Lunghezza operativa



0° / 12° / 30°	Ø 6.5 mm - 240 mm	tk 791-133
----------------	-------------------	-------------------

für Optik
for scope
pour optique
para óptica
per ottica

Außenschaft zur Dauerspülung - Arbeitslänge
Outer sheath for continuous flow - Working length
Gaine extérieure à irrigation permanente - Longueur du travail
Vaina exterior para irrigación continua - Longitud de trabajo
Camicia esterna a flusso continuo - Lunghezza operativa

tk 791-138

Obturator für tk 791-132 und tk 791-137
Obturator for tk 791-132 and tk 791-137
Obturateur pour tk 791-132 et tk 791-137
Obturator para tk 791-132 y tk 791-137
Otturatore per tk 791-132 e tk 791-137





Operations-Dauerspülschäfte
Continuous flow operating sheaths

Gaines avec irrigation permanente
Vainas con irrigación y succión continua
Camicie operative a flusso continuo

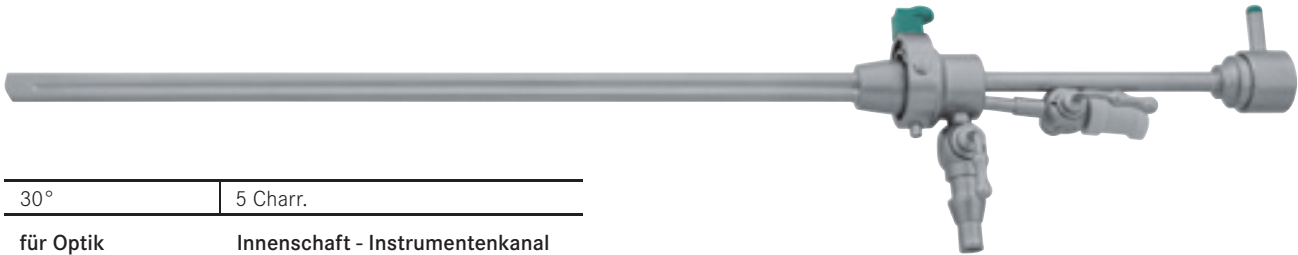

30°	5 Charr.
-----	----------

für Optik <i>for scope</i>	Innenschaft - Instrumentenkanal <i>Inner sheath - Instrument channel</i>
pour optique <i>para óptica</i> per ottica	Gaine intérieure - Canal d'instruments <i>Vaina interior - Canal para instrumentos</i> Camicia interna - Canale operativa



30°	Ø 7.0 mm - 190 mm
-----	-------------------

für Optik <i>for scope</i>	Außenschaft zur Dauerspülung - Arbeitslänge <i>Outer sheath for continuous flow - Working length</i>
pour optique <i>para óptica</i> per ottica	Gaine extérieure à irrigation permanente - Longueur du travail <i>Vaina exterior para irrigación continua - Longitud de trabajo</i> Camicia esterna a flusso continuo - Lunghezza operativa

tk 791-043

Komplett, Innen- und Außenschaft
Complete, inner and outer sheath
Complet, gaine intérieure et extérieure
Completo, vaina interior y exterior
Completo, camicia interna e esterna



Operations-Dauerspülschäfte
Continuous flow operating sheaths

Gaines avec irrigation permanente
Vainas con irrigación y succión continua
Camicie operative a flusso continuo



30°	7 Charr	tk 791-140
für Optik <i>for scope</i>	Instrumentenkanal <i>Instrument channel</i>	Innenschaft <i>Inner sheath</i>
pour optique <i>para óptica</i>	Canal d'instruments <i>Canal para instrumentos</i>	Gaine intérieur <i>Vaina interior</i>
per ottica	Canale operativo	Camicia interna



30°	Ø 7.0 mm - 182 mm	tk 791-134
für Optik <i>for scope</i>	Außenschaft zur Dauerspülung - Arbeitslänge <i>Outer sheath for continuous flow - Working length</i>	
pour optique <i>para óptica</i>	Gaine extérieure à irrigation permanente - Longueur du travail <i>Vaina exterior para irrigación continua - Longitud de trabajo</i>	
per ottica	Camicia esterna a flusso continuo - Lunghezza operativa	



tk 791-136

Obturator für tk 791-134
Obturator for tk 791-134
Obturateur pour tk 791-134
Obturator para tk 791-134
Otturatore per tk 791-134



Operationsschäfte
Operating sheaths

Gaines d'operations
Vainas operativas
Camicie operativa

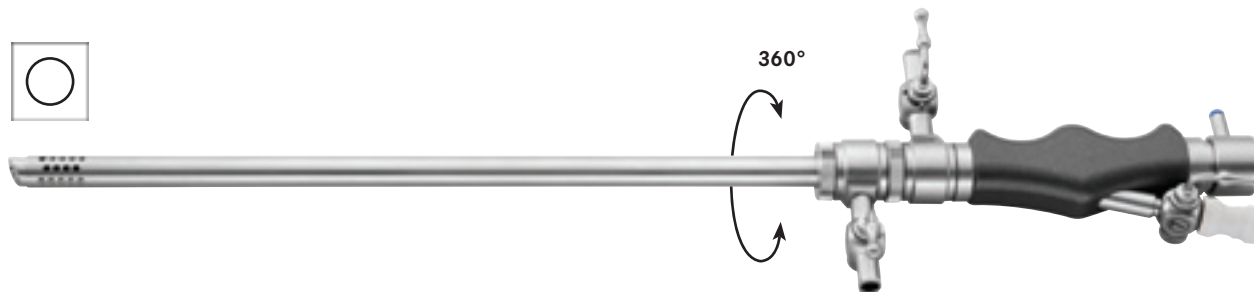

0°	Ø 8.0 mm - 200 mm	7 Charr.	tk 791-070
30°	Ø 8.0 mm - 200 mm	7 Charr.	tk 791-072

für Optik
for scope

Schaft zur Dauerspülung - Arbeitslänge
Sheath for continuous flow - Working length

Instrumentenkanal
Instrument channel

pour optique
para óptica
per ottica

Gaine à irrigation permanente - Longueur du travail
Vaina para irrigación continua - Longitud de trabajo
Camicia per flusso continuo - Lunghezza operativa

Canal d'instruments
Canal para instrumentos
Canale operativo

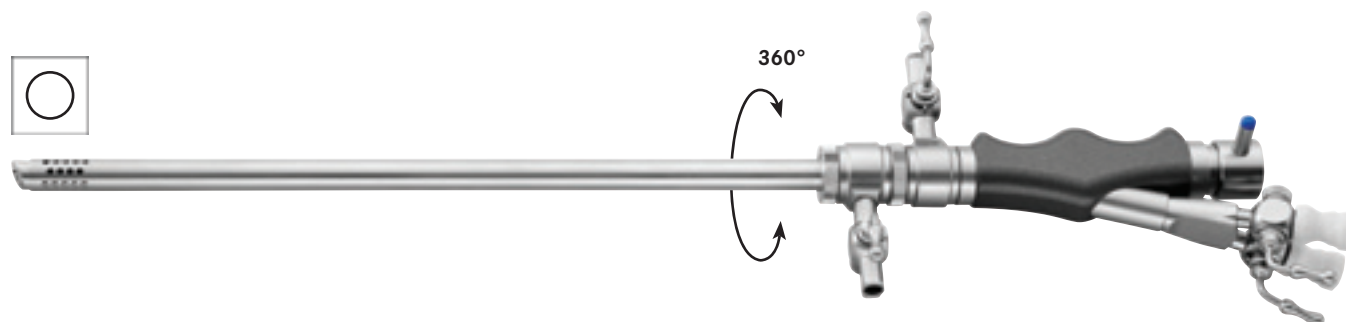

0°	Ø 8.0 mm - 200 mm	7 Charr	tk 791-074
30°	Ø 8.0 mm - 200 mm	7 Charr.	tk 791-076

für Optik
for scope

Schaft zur Dauerspülung - Arbeitslänge
Sheath for continuous flow - Working length

2 Instrumentenkanäle
2 Instrument channels

pour optique
para óptica
per ottica

Gaine à irrigation permanente - Longueur du travail
Vaina para irrigación continua - Longitud de trabajo
Camicia per flusso continuo - Lunghezza operativa

2 Canal d'instruments
2 Canal para instrumentos
2 Canale operativi

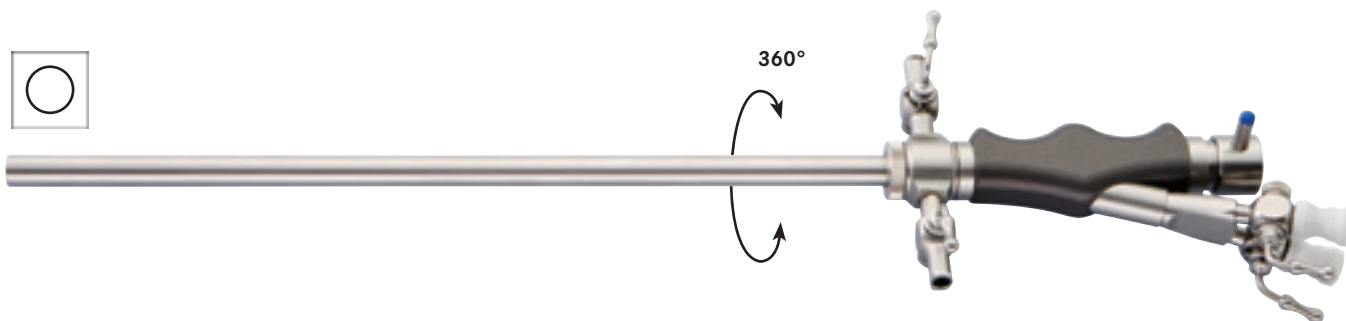

0°	Ø 8.0 mm - 200 mm	7 Charr.	tk 791-125
30°	Ø 8.0 mm - 200 mm	7 Charr.	tk 791-127

für Optik
for scope

Schaft - Arbeitslänge
Sheath - Working length

2 Instrumentenkanäle
2 Instrument channels

pour optique
para óptica
per ottica

Gaine - Longueur du travail
Vaina - Longitud de trabajo
Camicia - Lunghezza operativa

2 Canal d'instruments
2 Canal para instrumentos
2 Canale operativi



Arbeitseinsatz mit ALBARRAN Lenkhebel
Working insert with ALBARRAN deflector

Insert de travail ALBARRAN
Mecanismo de deflexión uña de ALBARRAN
Elemento operativo ALBARRAN

Arbeitseinsatz mit ALBARRAN Lenkhebel und 1 Instrumentenkanal
Working insert with ALBARRAN deflecting mechanism and 1 instrument channel

Insert de travail ALBARRAN avec 1 canal d'instrument
Inserto de trabajo ALBARRAN con 1 canal de instrumento
Elemento operativo ALBARRAN ad 1 canale operativo



0°/12°/30°/70°	7 Charr	tk 791-144
für Optik <i>for scope</i>	Instrumentenkanal <i>Instrument channel</i>	Innenschaft <i>Inner sheath</i>
pour optique <i>para óptica</i>	Canal d'instruments <i>Canal para instrumentos</i>	Gaine intérieure <i>Vaina interior</i>
per ottica	Canale operativo	Camicia interna



0°/12°/30°/70°	Ø 8.0 mm - 185 mm	tk 791-142
für Optik <i>for scope</i>	Außenschaft - Arbeitslänge <i>Outer sheath - Working length</i>	
pour optique <i>para óptica</i>	Gaine extérieure - Longueur du travail <i>Vaina exterior - Longitud de trabajo</i>	
per ottica	Camicia esterna - Lunghezza operativa	



tk 791-143

Obturator für tk 791-142
Obturator for tk 791-142
Obturateur pour tk 791-142
Obturator para tk 791-142
Otturatore per tk 791-142

Flexible Instrumente
Flexible instruments

Instruments flexibles
Instrumentos flexibles
Strumenti flessibili

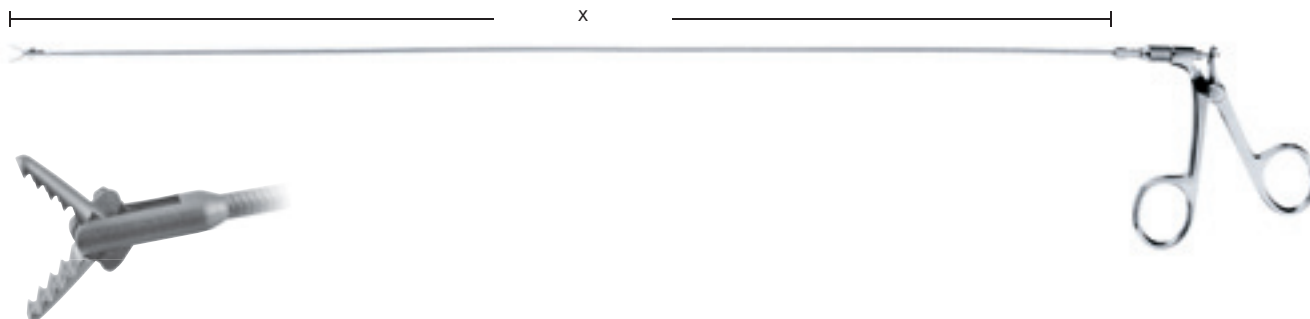

	x= 40 cm	x= 40 cm	x= 40 cm
5 Charr.	tk 790-219	tk 790-199	tk 790-239
7 Charr.	tk 790-226	tk 790-206	tk 790-246
9 Charr.	tk 790-227	tk 790-207	tk 790-247
Fasszange, Alligatormaul <i>Grasping forceps, alligator jaw</i>	halbstarr <i>semi-rigid</i>	flexibel <i>flexible</i>	flexibel und isoliert <i>flexible and insulated</i>
Pince à saisir, mors crocodil <i>Pinza de agarre con dientes de cocodrilo</i>	semi-rigide <i>semi-rígido</i>	flexible <i>flexible</i>	flexible isolée <i>flexible con aislamiento</i>
Pinza da presa con morso a coccodrillo	semi rigida	flessibile	flessibile e isolata



	x= 40 cm	x= 40 cm	x= 40 cm
5 Charr.	tk 790-217	tk 790-197	tk 790-237
7 Charr.	tk 790-222	tk 790-202	tk 790-242
9 Charr.	tk 790-223	tk 790-203	tk 790-243
Biopsiezange, Löffel oval <i>Biopsy forceps, oval spoon</i>	halbstarr <i>semi-rigid</i>	flexibel <i>flexible</i>	flexibel und isoliert <i>flexible and insulated</i>
Pince à biopsie, mors oval <i>Pinza para biopsia, cuchara oval</i>	semi-rigide <i>semi-rígido</i>	flexible <i>flexible</i>	flexible isolée <i>flexible con aislamiento</i>
Pinza da biopsia a cucciaio ovale	semi rigida	flessibile	flessibile e isolata



	x= 40 cm	x= 40 cm	x= 40 cm
5 Charr.	tk 790-218	tk 790-198	tk 790-238
7 Charr.	tk 790-224	tk 790-204	tk 790-244
9 Charr.	tk 790-225	tk 790-205	tk 790-245
Biopsiezange, Löffel oval, gezahnt <i>Biopsy forceps, oval spoon, serrated</i>	halbstarr <i>semi-rigid</i>	flexibel <i>flexible</i>	flexibel und isoliert <i>flexible and insulated</i>
Pince à biopsie, mors oval, dentelée <i>Pinza para biopsia, cuchara oval, dentado</i>	semi-rigide <i>semi-rígido</i>	flexible <i>flexible</i>	flexible isolée <i>flexible con aislamiento</i>
Pinza da biopsia a cucciaio ovale, dentellata	semi rigida	flessibile	flessibile e isolata

Flexible Instrumente
Flexible instruments

 Instruments flexibles
Instrumentos flexibles
 Strumenti flessibili

	x= 40 cm	x= 40 cm	x= 40 cm
5 Charr.	tk 790-216	tk 790-196	tk 790-236
7 Charr.	tk 790-220	tk 790-200	tk 790-240
9 Charr.	tk 790-221	tk 790-201	tk 790-241
Scheren <i>Scissors</i>	halbstarr <i>semi-rigid</i>	flexibel <i>flexible</i>	flexibel und isoliert <i>flexible and insulated</i>
Ciseaux <i>Tijeras</i>	semi-rigide <i>semi-rígido</i>	flexible <i>flexible</i>	flexible isolée <i>flexible con aislamiento</i>
Forbice	semi rigida	flessibile	flessibile e isolata



	x= 40 cm	x= 40 cm	x= 40 cm
7 Charr.	tk 790-263	tk 790-262	tk 790-264
Scheren <i>Scissors</i>	halbstarr <i>semi-rigid</i>	flexibel <i>flexible</i>	flexibel und isoliert <i>flexible and insulated</i>
Ciseaux <i>Tijeras</i>	semi-rigide <i>semi-rígido</i>	flexible <i>flexible</i>	flexible isolée <i>flexible con aislamiento</i>
Forbice	semi rigida	flessibile	flessibile e isolata



	x= 40 cm	x= 40 cm	x= 40 cm
7 Charr.	tk 790-255	tk 790-250	tk 790-258
9 Charr.	tk 790-256	tk 790-251	tk 790-260
Hakenscheren <i>Hook scissors</i>	halbstarr <i>semi-rigid</i>	flexibel <i>flexible</i>	flexibel und isoliert <i>flexible and insulated</i>
Ciseaux á crochet <i>Tijeras de gancho</i>	semi-rigide <i>semi-rígido</i>	flexible <i>flexible</i>	flexible isolée <i>flexible con aislamiento</i>
Forbice ad uncino	semi rigida	flessibile	flessibile e isolata

 Andere Längen und Durchmesser auf Anfrage
Other lengths and diameters on request

 Autres longueurs et diamètres sur demande
Otras longitudes y diámetros sobre demanda

Altre lunghezze ed altri diametri disponibili su richiesta

Flexible Elektroden
Flexible electrodes

Electrodes flexibles
Electrodos flexibles
Elettrodi flessibili

Monopolar
Monopolar
Monopolaire
Monopolar
Monopolare



	x = 45 cm	x = 45 cm	x = 45 cm
3 Charr.	tk 790-482	tk 790-487	-
4 Charr.	tk 790-483	tk 790-488	-
5 Charr.	tk 790-280	tk 790-284	tk 790-288
6 Charr.	tk 790-282	-	-
7 Charr.	tk 790-281	tk 790-285	tk 790-289
8 Charr.	tk 790-484	-	-
9 Charr.	tk 790-485	-	tk 790-495
10 Charr.	tk 790-486	-	tk 790-496

	x = 65 cm	x = 65 cm	x = 65 cm
3 Charr.	tk 790-170	tk 790-177	-
4 Charr.	tk 790-171	tk 790-178	-
5 Charr.	tk 790-172	tk 790-179	tk 790-186
6 Charr.	tk 790-169	-	-
7 Charr.	tk 790-173	tk 790-180	tk 790-187
8 Charr.	tk 790-174	-	-
9 Charr.	tk 790-175	-	tk 790-189
10 Charr.	tk 790-176	-	tk 790-194

Kugelelektrode
Ball electrode

Electrode à boule
Electrodo de bola
Elettrodo a pallina

Nadelelektrode
Needle electrode

Electrode à aiguille
Electrodo de aguja
Elettrodo a agho

Schlingenelektrode
Loop electrode

Electrode de asa
Electrodo de lazo
Elettrodo ad ansa

Bipolar
Bipolar
Bipolaire
Bipolar
Bipolare

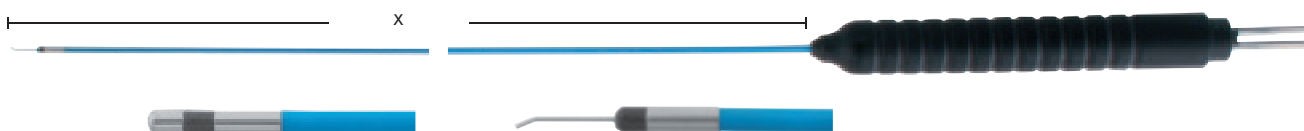

	x = 36 cm	x = 36 cm
5 Charr.	tk 790-150	tk 790-151

Kugelelektrode
Ball electrode

Electrode à boule
Electrodo de bola
Elettrodo a pallina

Nadelelektrode
Needle electrode

Electrode à aiguille
Electrodo de aguja
Elettrodo ad agho













Hochfrequenzkabel
High frequency cable

Câble de haute fréquence
Cable alta frecuencia
Cavo ad alta frequenza

Monopolar, 3 m
Monopolar, 3 m
Monopolaire, 3 m
Monopolar, 3 m
Monopolare, 3 m

	Aesculap, Berchtold, Martin	Ø = 4 mm	tk 790-310	
	Storz, Erbe	Ø = 5 mm	tk 790-311	
	Tekno, Valleylab, Bovie	Ø = 8 mm	tk 790-312	
	Berchtold, Martin	Ø = 4 mm	tk 790-313	

Bipolar, 3 m
Bipolar, 3 m
Bipolaire, 3 m
Bipolar, 3 m
Bipolare, 3 m

	Erbe ICC/ACC, Wisap, Storz	Flat plug round	tk 707-330	
		Flat plug square	tk 707-300	
	Martin, Berchtold	Flat plug round	tk 707-331	
		Flat plug square	tk 707-301	
	TEKNO, Valleylab USA	Flat plug round	tk 707-332	
		Flat plug square	tk 707-302	
	TEKNO, Valleylab Europe	Flat plug round	tk 707-333	
		Flat plug square	tk 707-303	

Geräteseite
Unit side
Côté appareils
Lado equipos
Lato elettrobisturi



Instrumentenseite
Instrument side
Côté instrument
Lado instrumento
Lato strumento

Symbole und Besonderheiten
Symbols and characteristics

Symboles et caractéristiques
Símbolos y características
Simboli e caratteristiche

Farberkennung für jeweilige Charr.
Colour code for respective Charr.

Marquage en couleur pour respectives Charr.
Identificación de color para cada Charr.
Identificazione a colori per i relativi Charr.

19/22 Charr.	
24/26 Charr.	
27/28,5 Charr.	

Auch mit Plastikhähnen lieferbar
Also available with plastic stopcocks
Aussi disponible avec robinets en plastique
También disponible con llaves en plastica
Anche disponibili con rubinetto in plastica

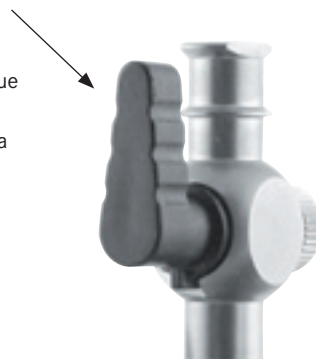

drehbar
rotatable
rotative
giratoria
rotante

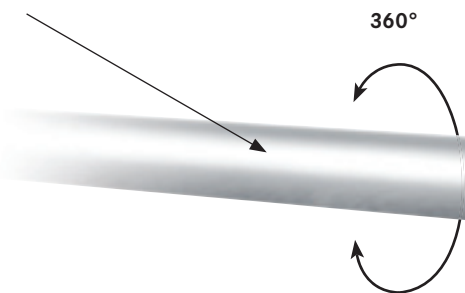

360°

Schnellverschluss (QL-Verriegelung)
Quick-lock fixation
Fixation rapide, quick-lock
Fijación rápida, quick-lock
Chiusura rapida, quick-lock

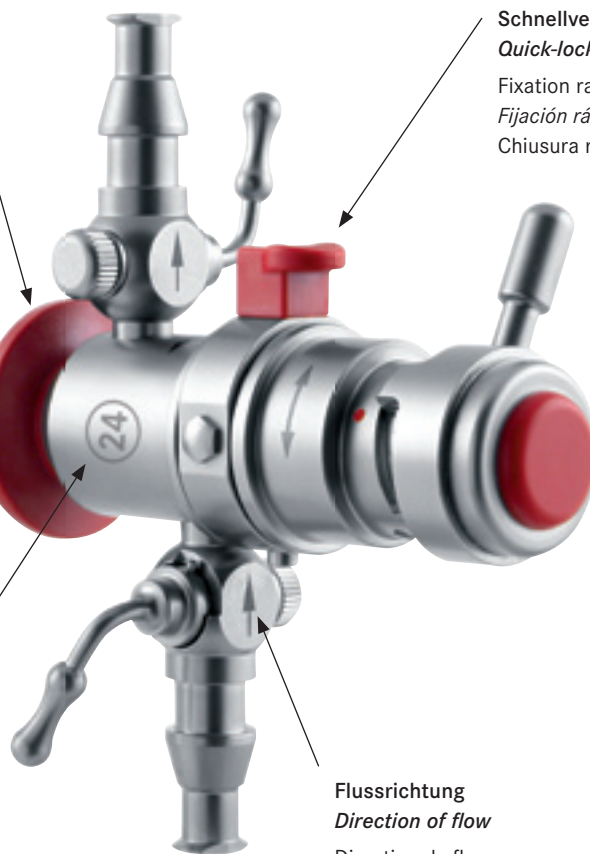

Maßangaben in Charr.
Measurements in Charr.
Mesures en Charr.
Dimensiones en Charr.
Misure in Charr.

Flussrichtung
Direction of flow
Direction de flux
Dirección del flujo
Direzione del flusso

 = Durchmesser Aussenschaft
Outer diameter sheath
Diamètre de la gaine externe
Diametro de la vaina externa
Diametro camicia esterna

 = Durchmesser Innenschaft
Inner diameter sheath
Diamètre de la gaine interne
Diametro de la vaina interna
Diametro camicia interna

Systemübersicht
System overview

Aperçu général du système
Vista general del sistema
Visione sul sistema

⊙ 19 / ⊙ 22 Charr.	■
⊙ 24 / ⊙ 26 Charr.	■
⊙ 27 / ⊙ 28,5 Charr.	■



Elektroden
Electrodes
Electrodes
Elettrodi

■ tk 791-420 - tk 791-423
■ tk 791-350 - tk 791-365
■ tk 791-450 - tk 791-465

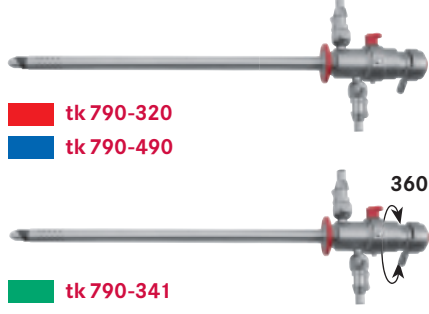

■ tk 790-320
■ tk 790-490

■ tk 790-341
■ tk 790-330
■ tk 790-315

360°



■ tk 790-324
■ tk 790-323
■ tk 790-318

Systemübersicht
System overview

Aperçu général du système
Vista general del sistema
Visione sul sistema

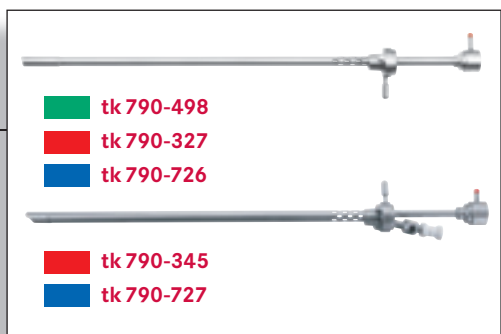
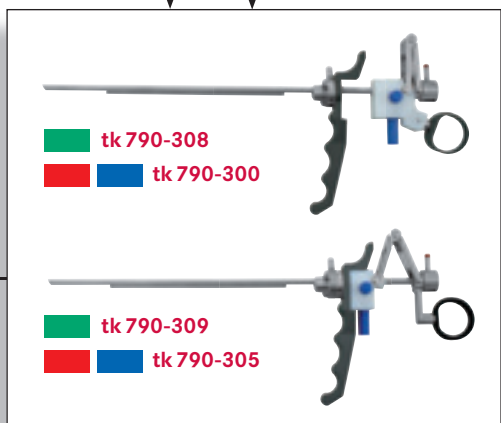

Optiken | Optiques
 Scopes | Ópticas
 Ottiche

autoklavierbar / autoclavable
 134°C / 273°F - 18 min.

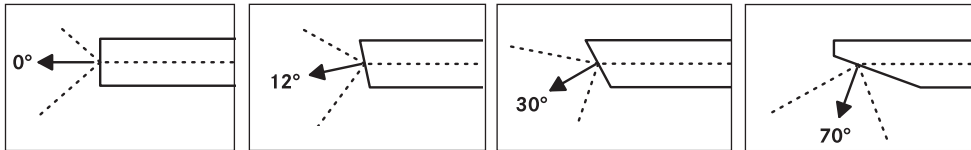

Ø 2.7 mm - 302 mm	tk 700-064	tk 700-065	tk 700-068	tk 700-069
Ø 2.9 mm - 302 mm	tk 700-059	tk 700-061	tk 700-066	-
Ø 4.0 mm - 302 mm	tk 700-074	tk 700-075	tk 700-078	tk 700-079

Ø 2.7 mm - 302 mm	tk 700-064SF	tk 700-065SF	tk 700-068SF	-
Ø 4.0 mm - 302 mm	tk 700-074SF	tk 700-075SF	tk 700-078SF	tk 700-079SF

Arbeitslänge
 Working length

Longueur de travail
 Longitud de trabajo
 Lunghezza operativa

SF = Tekno-Flex
 (see page 66)

Hochfrequenzkabel, monopolar, 3 m
 High frequency cables, monopolar, 3 m

Câbles de haute fréquence, monopolaire, 3 m
 Cables alta frecuencia, monopolar, 3 m
 Cavi ad alta frequenza, monopolare, 3 m

	Aesculap, Berchtold, Martin	Ø = 4 mm	tk 790-310	
	Storz, Erbe	Ø = 5 mm	tk 790-311	
	Tekno, Valleylab, Bovie	Ø = 8 mm	tk 790-312	
	Berchtold, Martin	Ø = 4 mm	tk 790-313	

Monopolare Arbeitselemente
Monopolar working elements

Eléments de travail monopolaires
Elementos de trabajo monopolares
Elementi operativi monopolari



19 Charr.		tk 790-308
-----------	---	-------------------

24 Charr.		tk 790-300
-----------	---	-------------------

Arbeitselement, passiv schneidend, einläufig
Working element, passive cutting, single stem

Elément de travail, coupe passive, single-stem
Elemento de trabajo, corte pasivo, un vástago
Elemento operativo passivo, un stelo



19 Charr.		tk 790-309
-----------	---	-------------------

24 Charr.		tk 790-305
-----------	---	-------------------

Arbeitselement, aktiv schneidend, einläufig
Working element, active cutting, single stem

Elément de travail, coupe active, single-stem
Elemento de trabajo, corte activo, un vástago
Elemento operativo attivo, un stelo



Auf Wunsch auch mit geschlossenem Griff erhältlich
Available with closed handle upon request

Disponible avec poignée fermée sur demande
Disponible con mango cerrado según de manda
Disponibile con manico chiuso su richiesta

Monopolare Elektroden
Monopolar electrodes

 Electrodes monopolaires
Electrodos monopolares
 Elettrodi monopolari

 einläufig
single stem
 single-stem
un vástago
 un stelo

Messerelektrode, gewinkelt 90°
Knife electrode, angled 90°
 Electrode à couteau, coudée 90°
Electrodo de cuchillo, angulado 90°
 Elettrodo a bisturi, angolato 90°

 19 Charr.

 24 Charr.

 27 Charr.

tk 791-420
tk 791-350
tk 791-450

Schlingenelektrode, gerade
Loop electrode, straight
 Electrode à anse, droit
Electrodo de asa, recto
 Elettrodo ad ansa, retto

tk 791-424
tk 791-351
tk 791-451

Schlingenelektrode, gewinkelt 30°
Loop electrode, angled 30°
 Electrode à anse, coudée, 30°
Electrodo de asa, angulado 30°
 Elettrodo ad ansa, angolato 30°

tk 791-421
tk 791-352
tk 791-452

only for 0° scopes
Schlingenelektrode, gewinkelt 90°
Loop electrode, angled 90°
 Electrode à anse, coudée, 90°
Electrodo de asa, angulado 90°
 Elettrodo ad ansa, angolato 90°

-

tk 791-357
tk 791-457

Vaporisationselektrode, gerieft, Ø 3 mm
Vaporization electrode, serrated, Ø 3 mm
 Electrode de vaporisation, striée, Ø 3 mm
Electrodo de vaporización, estriado, Ø 3 mm
 Elettrodo per vaporizzazione, scanalato, Ø 3 mm

-

tk 791-358
tk 791-458

Vaporisationselektrode, gerieft, Ø 5 mm
Vaporization electrode, serrated, Ø 5 mm
 Electrode de vaporisation, striée, Ø 5 mm
Electrodo de vaporización, estriado, Ø 5 mm
 Elettrodo per vaporizzazione, scanalato, Ø 5 mm

-

tk 791-353
tk 791-453



 Packung à 6 Stck.
Box of 6 pcs.
 Paquet de 6 pcs.
Paquete de 6 pzas.
 Confezione con 6 pezzi

Monopolare Elektroden
Monopolar electrodes

Electrodes monopolaires
Electrodos monopolares
Elettrodi monopolari

einläufig
single stem
single-stem
un vástago
un stelo



	 19 Charr.	 24 Charr.	 27 Charr.
Kugelelektrode, Ø 3 mm <i>Ball electrode, Ø 3 mm</i> Electrode à boule, Ø 3 mm <i>Electrodo de bola, Ø 3 mm</i> Elettrodo a pallina, Ø 3 mm	tk 791-423	tk 791-354	tk 791-454
Kugelelektrode, Ø 5 mm <i>Ball electrode, Ø 5 mm</i> Electrode à boule, Ø 5 mm <i>Electrodo de bola, Ø 5 mm</i> Elettrodo a pallina, Ø 5 mm	-	tk 791-363	tk 791-463
Kegelelektrode <i>Cone electrode</i> Electrode conique <i>Electrodo conico</i> Elettrodo a cono	-	tk 791-355	tk 791-455
Schneide/Vaporisationselektrode <i>Vaporisation electrode</i> Électrode de vaporisation <i>Electrodo de vaporización</i> Elettrodo per vaporizzazione	-	tk 791-359	-
Rollenelektrode, glatt, Ø 3 mm <i>Roller electrode, smooth, Ø 3 mm</i> Electrode forme rouleau, lisse, Ø 3 mm <i>Electrodo de rollo, liso, Ø 3 mm</i> Elettrodo a ruolo, smusso, Ø 3 mm	tk 791-422	tk 791-367	tk 791-467
Rollenelektrode, glatt, Ø 5 mm <i>Roller electrode, smooth, Ø 5 mm</i> Electrode forme rouleau, lisse, Ø 5 mm <i>Electrodo de rollo, liso, Ø 5 mm</i> Elettrodo a ruolo, smusso, Ø 5 mm	-	tk 791-365	tk 791-465

Packung à 6 Stck.
Box of 6 pcs.
Paquet de 6 pcs.
Paquete de 6 pzas.
Confezione con 6 pezzi

tk 790-374

Schutzhülse zur Sterilisation von Elektroden
Protection tube for sterilization of electrodes

Tube de protection et stérilisation des électrodes

Tubo protector para la esterilización de electrodos

Camicia di protezione per sterilizzazione degli elettrodi



Monopolare Schäfte
Monopolar sheaths

 Gains de travail monopolaires
Vainas de trabajo monopolares
 Camicia operativi monopolari

 drehbar
 rotatable
 rotative
 giratoria
 rotante

⊕ 19 / ⊕ 22 Charr. ■	tk 790-344	tk 790-343	tk 790-324
Resektoskopschaft zur Dauerspülung <i>Resectoscope sheath for continuous flow</i>	Außenschaft <i>Outer sheath</i>	Innenschaft <i>Inner sheath</i>	Obturator <i>Obturator</i>
Gaine de résectoscopie à irrigation permanente <i>Vaina de resectoscopio para irrigación continua</i>	Gaine extérieur <i>Vaina exterior</i>	Gaine intérieur <i>Vaina interior</i>	Obturateur <i>Obturator</i>
Camicia resettoscopia a lavaggio continuo	Camicia esterna	Camicia interna	Otturatore
tk 790-341	x	x	x

 komplett
complete
 complet
completo
 completo

⊕ 24 / ⊕ 26 Charr. ■	tk 790-331	tk 790-332	tk 790-323
Resektoskopschaft zur Dauerspülung <i>Resectoscope sheath for continuous flow</i>	Außenschaft <i>Outer sheath</i>	Innenschaft <i>Inner sheath</i>	Obturator <i>Obturator</i>
Gaine de résectoscopie à irrigation permanente <i>Vaina de resectoscopio para irrigación continua</i>	Gaine extérieur <i>Vaina exterior</i>	Gaine intérieur <i>Vaina interior</i>	Obturateur <i>Obturator</i>
Camicia resettoscopia a lavaggio continuo	Camicia esterna	Camicia interna	Otturatore
tk 790-330	x	x	x

 komplett
complete
 complet
completo
 completo

⊕ 27 / ⊕ 28,5 Charr. ■	tk 790-316	tk 790-317	tk 790-318
Resektoskopschaft zur Dauerspülung <i>Resectoscope sheath for continuous flow</i>	Außenschaft <i>Outer sheath</i>	Innenschaft <i>Inner sheath</i>	Obturator <i>Obturator</i>
Gaine de résectoscopie à irrigation permanente <i>Vaina de resectoscopio para irrigación continua</i>	Gaine extérieur <i>Vaina exterior</i>	Gaine intérieur <i>Vaina interior</i>	Obturateur <i>Obturator</i>
Camicia resettoscopia a lavaggio continuo	Camicia esterna	Camicia interna	Otturatore
tk 790-315	x	x	x

 komplett
complete
 complet
completo
 completo

Monopolare Schäfte
Monopolar sheaths

Gaines de travail monopolaires
Vainas de trabajo monopolares
Camicia operativi monopolari



⊕ 24 / ⊕ 26 Charr. ■	tk 790-321	tk 790-322	tk 790-323
Resektoskopschaft zur Dauerspülung <i>Resectoscope sheath for continuous flow</i>	Außenschaft <i>Outer sheath</i>	Innenschaft <i>Inner sheath</i>	Obturator <i>Obturator</i>
Gaine de résectoscopie à irrigation permanente <i>Vaina de resectoscopio para irrigación continua</i>	Gaine extérieur <i>Vaina exterior</i>	Gaine intérieur <i>Vaina interior</i>	Obtuteur <i>Obturador</i>
Camicia resettoscopia a lavaggio continuo	Camicia esterna	Camicia interna	Otturatore
tk 790-320	x	x	x

komplett
complete
complet
completo
completo

⊕ 27 / ⊕ 28,5 Charr. ■	tk 790-491	tk 790-492	tk 790-318
Resektoskopschaft zur Dauerspülung <i>Resectoscope sheath for continuous flow</i>	Außenschaft <i>Outer sheath</i>	Innenschaft <i>Inner sheath</i>	Obturator <i>Obturator</i>
Gaine de résectoscopie à irrigation permanente <i>Vaina de resectoscopio para irrigación continua</i>	Gaine extérieur <i>Vaina exterior</i>	Gaine intérieur <i>Vaina interior</i>	Obtuteur <i>Obturador</i>
Camicia resettoscopia a lavaggio continuo	Camicia esterna	Camicia interna	Otturatore
tk 790-490	x	x	x

komplett
complete
complet
completo
completo



Bitte fordern Sie unseren Spezialkatalog an.
Please ask for our special catalogue.

Veuillez demander pour notre catalogue spécial.



Por favor preguntan para el catálogo especial.

Per favore domandate per il nostro catalogo speciale.

Obturatoren
Obturator

Obturateurs
Obturadores
Otturatori





19 Charr.		tk 790-324
24 Charr.		tk 790-323
27 Charr.		tk 790-318

Standardobturator
Standard obturator

Obturateur standard
Obturador estándar
Otturatore standard





19 Charr.		tk 790-498
24 Charr.		tk 790-327
27 Charr.		tk 790-726

Sichtobturator für Dauerspülung
Visual obturator for continuous flow

Obturateur visuel pour irrigation permanente
Obturador óptico para irrigación continua
Otturatore ottico per lavaggio continuo



24 Charr.		- Ø 5 Charr.	tk 790-345
27 Charr.		- Ø 7 Charr.	tk 790-727

Sichtobturator mit einem Instrumentenkanal
Visual obturator with one instrument channel

Obturateur visuel avec canal d'instruments
Obturador óptico con un canal para instrumentos
Otturatore ottico con un canale per strumenti

Systemübersicht
System overview

Aperçu général du système
Vista general del sistema
Visione sul sistema

BIPOLARK

⊕ 19 / ⊖ 22 Charr.	■
⊕ 24 / ⊖ 26 Charr.	■

Elektroden
Electrodes
Electrodes
Electrodos
Elettrodi

■ tk 799-360 - 799-366
■ tk 799-350 - 799-373

■ tk 799-320

■ tk 799-310
■ tk 799-330

■ tk 799-328

■ tk 799-335

■ tk 790-324
■ tk 790-323

Systemübersicht
System overview

Aperçu général du système
Vista general del sistema
Visione sul sistema



Kabel
Cable
Câble
Cable
Cavo

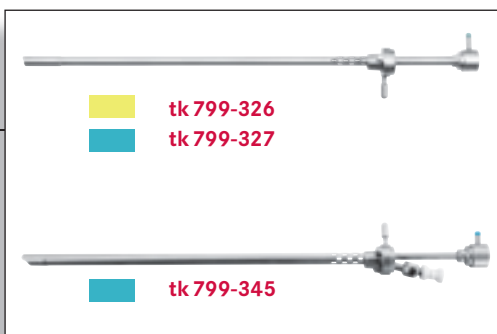
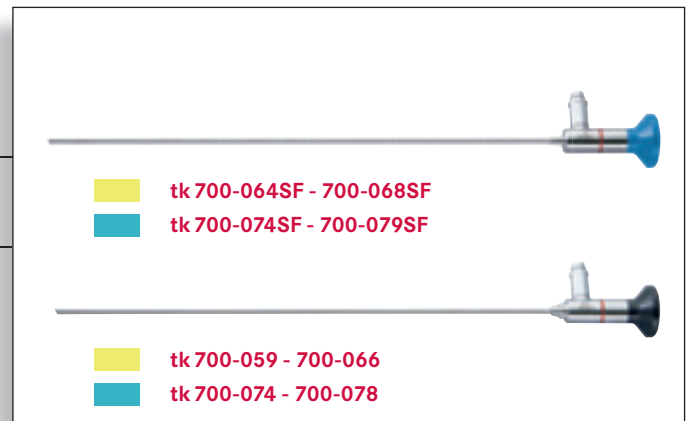
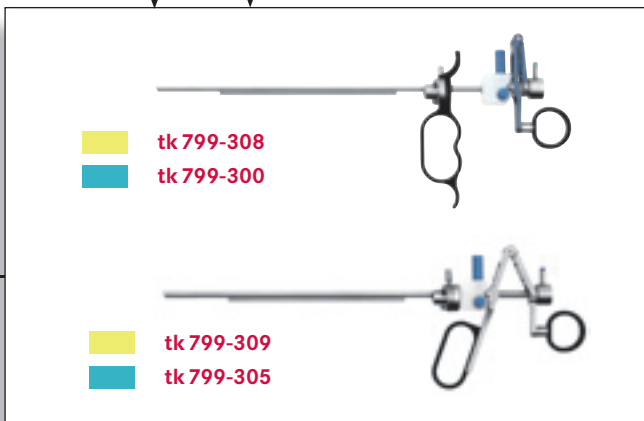

Optiken | Optiques
 Scopes | Ópticas
 Ottiche

autoklavierbar / autoclavable
 134°C / 273°F - 18 min.

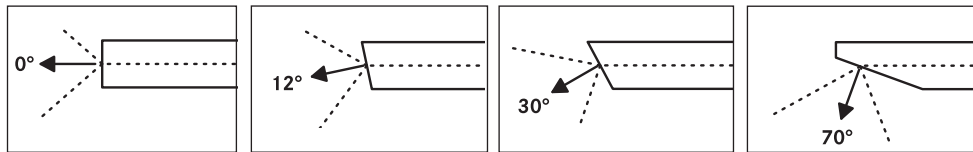

Ø 2.7 mm - 302 mm	tk 700-064	tk 700-065	tk 700-068	tk 700-069
Ø 2.9 mm - 302 mm	tk 700-059	tk 700-061	tk 700-066	-
Ø 4.0 mm - 302 mm	tk 700-074	tk 700-075	tk 700-078	tk 700-079
Ø 2.7 mm - 302 mm	tk 700-064SF	tk 700-065SF	tk 700-068SF	-
Ø 4.0 mm - 302 mm	tk 700-074SF	tk 700-075SF	tk 700-078SF	tk 700-079SF

Arbeitslänge
 Working length

Longueur de travail
 Longitud de trabajo
 Lunghezza operativa

SF = Tekno-Flex
 (see page 66)

Hochfrequenzkabel, monopolar, 3 m
 High frequency cables, monopolar, 3 m
 Câbles de haute fréquence, monopolaire, 3 m
 Cables alta frecuencia, monopolar, 3 m
 Cavi ad alta frequenza, monopolare, 3 m

	Aesculap, Berchtold, Martin	Ø = 4 mm	tk 790-310	
	Storz, Erbe	Ø = 5 mm	tk 790-311	
	Tekno, Valleylab, Bovie	Ø = 8 mm	tk 790-312	
	Berchtold, Martin	Ø = 4 mm	tk 790-313	

Bipolare Arbeitselemente
Bipolar working elements

Eléments de travail bipolaires
Elementos de trabajo bipolares
Elementi operativi bipolari



19 Charr.		tk 799-308
24 Charr.		tk 799-300

Arbeitselement, passiv schneidend, einläufig
Working element, passive cutting, single stem
Elément de travail, coupe passive, single-stem
Elemento de trabajo, corte pasivo, un vástago
Elemento operativo passivo, un stelo



19 Charr.		tk 799-309
24 Charr.		tk 799-305

Arbeitselement, aktiv schneidend, einläufig
Working element, active cutting, single stem
Elément de travail, coupe active, single-stem
Elemento de trabajo, corte activo, un vástago
Elemento operativo attivo, un stelo

Hochfrequenzkabel, bipolar
High frequency cable, bipolar

Câble de haute fréquence, bipolaire
Cable alta frecuencia, bipolar
Cavo ad alta frequenza, bipolare









TEKNO TOM 411 PRO	tk 707-350	3 m
Geräteseite <i>Unit side</i>		Instrumentenseite <i>Instrument side</i>
Coté appareil <i>Lado equipo</i> Lato elettrobisturi		Coté instrument <i>Lado instrumento</i> Lato strumento



Bipolare Elektroden
Bipolar electrodes

 Electrodes bipolaires
Electrodos bipolares
 Elettrodi bipolari

BIPOLARK

	19 Charr.	24 Charr.		
 Schlingenelektrode, gerade, für die Blase <i>Loop electrode, straight, for the bladder</i> Electrode à anse, droit, pour la vessie <i>Electrodo de asa, recto, para la vejiga</i> Elettrodo ad ansa, retto, per la vescica	tk 799-361	tk 799-351	0°/12°	0°/30°
 Schlingenelektrode, gerade, für Prostata/Urethra <i>Loop electrode, straight, for prostate/urethra</i> Electrode à anse, droit, pour prostate/urètre <i>Electrodo de asa, recto, para prostata/uretra</i> Elettrodo ad ansa, retto, per prostata/uretra	-	tk 799-371	0°/12°	0°/30°
 Schlingenelektrode, gewinkelt 30°, für die Blase <i>Loop electrode, angled 30°, for the bladder</i> Electrode à anse, coudée, 30°, droit, pour la vessie <i>Electrodo de asa, angulado 30°, recto, para la vejiga</i> Elettrodo ad ansa, angolato 30°, retto, per la vescica	tk 799-362	tk 799-352	30°	0°/30°
 Schlingenelektrode, gewinkelt 30°, für Prostata/Urethra <i>Loop electrode, angled 30°, for prostate/urethra</i> Electrode à anse, coudée, 30°, pour prostate/urètre <i>Electrodo de asa, angulado 30°, para prostata/uretra</i> Elettrodo ad ansa, angolato 30°, per prostata/uretra	-	tk 799-372	30°	0°/30°
 Schlingenelektrode, gewinkelt 90°, für die Blase <i>Loop electrode, angled 90°, for the bladder</i> Electrode à anse, coudée, 90°, droit, pour la vessie <i>Electrodo de asa, angulado 90°, recto, para la vejiga</i> Elettrodo ad ansa, angolato 90°, retto, per la vescica	-	tk 799-353	0°/12°	0°
 Schlingenelektrode, gewinkelt 90°, für Prostata/Urethra <i>Loop electrode, angled 90°, for prostate/urethra</i> Electrode à anse, coudée, 90°, pour prostate/urètre <i>Electrodo de asa, angulado 90°, para prostata/uretra</i> Elettrodo ad ansa, angolato 90°, per prostata/uretra	-	tk 799-373	0°/12°	0°

 Packung à 6 Stck.
Box of 6 pcs

 Paquet de 6 pcs.
Paquete de 6 pzas.

Confezione con 6 pezzi

 für Optik
for scope

 pour optiques
para ópticas
 per ottiche



 für Schäfte
for sheaths

 pour gaines
para vainas
 per camicie

Bipolare Elektroden
Bipolar electrodes

Electrodes bipolaires
Electrodos bipolares
Elettrodi bipolari



	 19 Charr.	 24 Charr.		
Vaporisationselektrode, gerieft, Ø 3 mm <i>Vaporization electrode, serrated, Ø 3 mm</i> Electrode de vaporisation, striée, Ø 3 mm <i>Electrodo de vaporización, estriado, Ø 3 mm</i> Elettrodo per vaporizzazione, scanalato, Ø 3 mm	-	tk 799-354	0° / 12° / 30°	0° / 30°
Kugelelektrode, Ø 3 mm <i>Ball electrode, Ø 3 mm</i> Electrode à boule, Ø 3 mm <i>Electrodo de bola, Ø 3 mm</i> Elettrodo a pallina, Ø 3 mm	tk 799-365	tk 799-355	0° / 12° / 30°	0° / 30°
Rollenelektrode, glatt, Ø 3 mm <i>Roller electrode, smooth, Ø 3 mm</i> Electrode forme rouleau, lisse, Ø 3 mm <i>Electrodo de rollo, liso, Ø 3 mm</i> Elettrodo a ruolo, smusso, Ø 3 mm	tk 799-366	tk 799-356	0° / 12° / 30°	0° / 30°
Messerelektrode, gewinkelt 90° <i>Knife electrode, angled 90°</i> Electrode à couteau, coudée 90° <i>Electrodo de cuchillo, angulado 90°</i> Elettrodo a bisturi, angolato 90°	tk 799-360	tk 799-350	0° / 12° / 30°	0° / 30°
Kegelelektrode <i>Cone electrode</i> Electrode conique <i>Electrodo conico</i> Elettrodo a cono	-	tk 799-357	0° / 12° / 30°	0° / 30°

Packung à 6 Stck.
Box of 6 pcs
Paquet de 6 pcs.
Paquete de 6 pzas.
Confezione con 6 pezzi

für Optik
for scope
pour optiques
para ópticas
per ottiche

für Schäfte
for sheaths
pour gaines
para vainas
per camicie

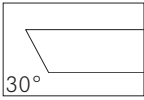

Bipolare Schäfte
Bipolar sheats

Gaines de travail bipolaires
Vaina de trabajo bipolares
Camicia operativi bipolari

BIPOLAR 

drehbar
rotatable
rotative
giratoria
rotante



⊕ 19 / ⊕ 22 Charr. 	tk 799-311	tk 799-312	tk 799-313
Resektoskopschaft zur Dauerspülung <i>Resectoscope sheath for continuous flow</i>	Außenschaft <i>Outer sheath</i>	Innenschaft <i>Inner sheath</i>	Obturator <i>Obturator</i>
Gaine de résectoscopie à irrigation permanente <i>Vaina de resectoscopio para irrigación continua</i>	Gaine extérieur <i>Vaina exterior</i>	Gaine intérieur <i>Vaina interior</i>	Obturateur <i>Obturator</i>
Camicia resettoscopia a lavaggio continuo	Camicia esterna	Camicia interna	Otturatore
tk 799-310	x	x	x
komplett <i>complete</i>			
complet <i>completo</i>			
completo			

⊕ 24 / ⊕ 26 Charr. 	tk 799-331	tk 799-332	tk 799-323
Resektoskopschaft zur Dauerspülung <i>Resectoscope sheath for continuous flow</i>	Außenschaft <i>Outer sheath</i>	Innenschaft <i>Inner sheath</i>	Obturator <i>Obturator</i>
Gaine de résectoscopie à irrigation permanente <i>Vaina de resectoscopio para irrigación continua</i>	Gaine extérieur <i>Vaina exterior</i>	Gaine intérieur <i>Vaina interior</i>	Obturateur <i>Obturator</i>
Camicia resettoscopia a lavaggio continuo	Camicia esterna	Camicia interna	Otturatore
tk 799-330	x	x	x
komplett <i>complete</i>			
complet <i>completo</i>			
completo			

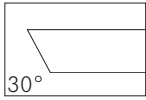

Bipolare Schäfte
Bipolar sheaths

Gaines de travail bipolaires
Vaina de trabajo bipolares
Camicia operativi bipolarari

BIPOLARK



⊕ 24 / ⊕ 26 Charr.	tk 799-321	tk 799-322	tk 799-323
Resektoskopschaft zur Dauerspülung <i>Resectoscope sheath for continuous flow</i>	Außenschaft <i>Outer sheath</i>	Innenschaft <i>Inner sheath</i>	Obturator <i>Obturator</i>
Gaine de résectoscopie à irrigation permanente <i>Vaina de resectoscopio para irrigación continua</i>	Gaine extérieur <i>Vaina exterior</i>	Gaine intérieur <i>Vaina interior</i>	Obturateur <i>Obturador</i>
Camicia resettoscopia a lavaggio continuo	Camicia esterna	Camicia interna	Otturatore
tk 799-320	x	x	x
komplett <i>complete</i>			
complet <i>completo</i>			
completo			

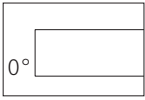

Bipolare Schäfte
Bipolar sheaths

Gaine de travail bipolaires
Vaina de trabajo bipolares
Camicia operativi bipolari

BIPOLARTK

drehbar
rotatable
rotative
giratoria
rotante



⊖ 24 / ⊖ 26 Charr. 	tk 799-331	tk 799-333	tk 799-323
Resektoskopschaft zur Dauerspülung <i>Resectoscope sheath for continuous flow</i>	Außenschaft <i>Outer sheath</i>	Innenschaft <i>Inner sheath</i>	Obturator <i>Obturator</i>
Gaine de résectoscopie à irrigation permanente <i>Vaina de resectoscopia para irrigación continua</i>	Gaine extérieur <i>Vaina exterior</i>	Gaine intérieur <i>Vaina interior</i>	Obturateur <i>Obturador</i>
Camicia resettoscopia a lavaggio continuo	Camicia esterna	Camicia interna	Otturatore
tk 799-335	x	x	x
komplett <i>complete</i>			
complet <i>completo</i>			
completo			



mit gerader Keramik für 0°/12° Endoskope
with straight ceramic for 0°/12° endoscopes
embout céramique droit pour optiques 0°/12°
punta ceramica recta para ópticas 0°/12°
con punta retta di ceramica per ottiche 0°/12°

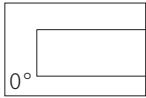

Bipolare Schäfte
Bipolar sheaths

Gaine de travail bipolaires
Vaina de trabajo bipolares
Camicia operativi bipolarari

BIPOLARTK



⊕ 24 / ⊕ 26 Charr. TK	tk 799-321	tk 799-324	tk 799-323
Resektoskopschaft zur Dauerspülung <i>Resectoscope sheath for continuous flow</i>	Außenschaft <i>Outer sheath</i>	Innenschaft <i>Inner sheath</i>	Obturator <i>Obturator</i>
Gaine de résectoscopie à irrigation permanente <i>Vaina de resectoscopio para irrigación continua</i>	Gaine extérieur <i>Vaina exterior</i>	Gaine intérieur <i>Vaina interior</i>	Obturateur <i>Obturador</i>
Camicia resettoscopia a lavaggio continuo	Camicia esterna	Camicia interna	Otturatore
tk 799-328	x	x	x
komplett <i>complete</i>			
complet <i>completo</i>			
completo			



mit gerader Keramik für 0°/12° Endoskope
with straight ceramic for 0°/12° endoscopes
embout céramique droit pour optiques 0°/12°
punta ceramica recta para ópticas 0°/12°
con punta retta di ceramica per ottiche 0°/12°

Obturatoren
Obturator

Obturateur
Obturadores
Otturatori

BIPOLARK



19 Charr. tk 799-313

24 Charr. tk 799-323

Standardobturator
Standard obturator

Obturateur standard
Obturator estándar
Otturatore standard



19 Charr. tk 799-326

24 Charr. tk 799-327

Sichtobturator für Dauerspülung
Visual obturator for continuous flow

Obturateur visuel pour irrigation permanente
Obturator óptico para irrigación continua
Otturatore ottico per lavaggio continuo



24 Charr. - Ø 5 Charr. tk 799-345

Sichtobturator mit einem Instrumentenkanal
Visual obturator with one instrument channel

Obturateur visuel avec canal d'instruments
Obturator óptico con un canal para instrumentos
Otturatore ottico con un canale per strumenti

OP - Laparoscope
OP - Laparoscopes

OP - Laparoscopes
OP - Laparoscopios
Laparoscopi operativi

OP - Laparoskop mit integriertem Instrumentenkanal, 0° Weitwinkel, Paralleleinblick
OP - Laparoscope with integrated instrument channel, 0° wide angle, parallel view

OP - Laparoscope avec canal d'instruments incorporé, 0° grand angle, vision parallèle
OP - Laparoscopio con canal incorporado para instrumentos, 0° gran ángulo, vista paralela
Laparoscopio operativo con canale di lavoro, 0° grandangolo, vista parallela

autoklavierbar / autoclavable
134°C / 273°F - 18 min.

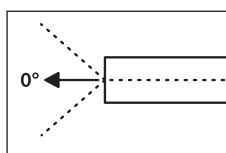
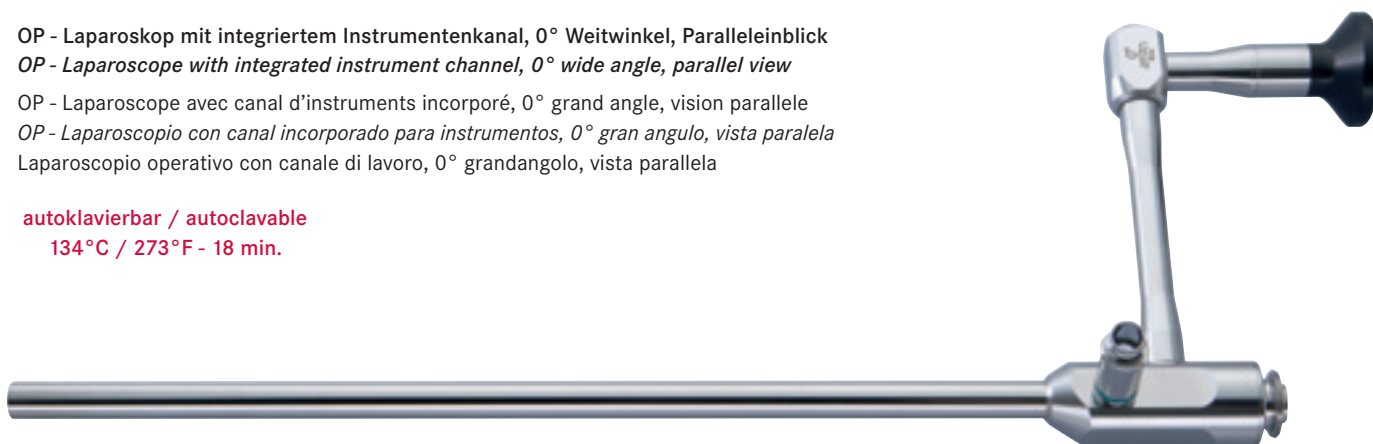

Ø 10.0 mm - 268 mm	Ø 6.0 mm	tk 700-250
Ø, Arbeitslänge	Instrumentenkanal	inkl. Adapter
Ø, Working length	Instrument channel	incl. adapter
Ø, Longueur de travail	Canal d'instrument	incl. adaptateur
Ø, Longitud de trabajo	Canal para instrumentos	Adaptador incluido
Ø, Lunghessa operativa	canale operativo	Adattore incluso

tk 700-255
Adapter
Adapter
Adaptateur
Adaptador
Adattore

OP - Laparoskop mit integriertem Instrumentenkanal, 0° Weitwinkel, Lateraleinblick
OP - Laparoscope with integrated instrument channel, 0° wide angle, lateral view

OP - Laparoscope avec canal d'instruments incorporé, 0° grand angle, vision latéral
OP - Laparoscopio con canal incorporado para instrumentos, 0° gran ángulo, vista lateral
Laparoscopio operativo con canale di lavoro, 0° grandangolo, vista laterale

autoklavierbar / autoclavable
134°C / 273°F - 18 min.

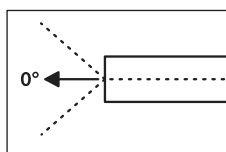

Ø 10.0 mm - 268 mm	Ø 6.0 mm	tk 700-251
Ø, Arbeitslänge	Instrumentenkanal	inkl. Adapter
Ø, Working length	Instrument channel	incl. adapter
Ø, Longueur de travail	Canal d'instrument	incl. adaptateur
Ø, Longitud de trabajo	Canal para instrumentos	Adaptador incluido
Ø, Lunghessa operativa	Canale operativo	Adattore incluso

tk 700-256
Adapter
Adapter
Adaptateur
Adaptador
Adattore

Ring Applikatoren
Ring applicators

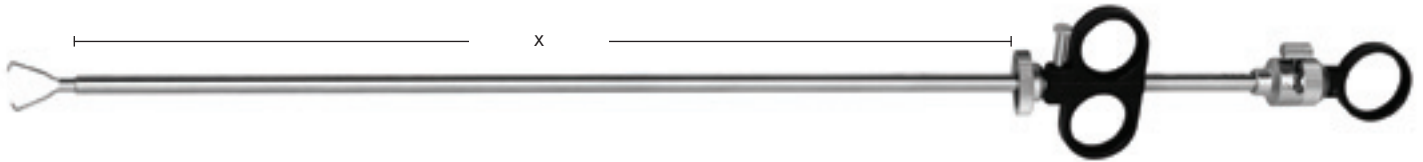
 Appicateurs des anneaux
Applicadores de anillos
 Applicatore per anelli

	x = 332 mm
Ø 6 mm - 18 Charr.	tk 791-180

Zur Anwendung mit OP-Laparoskop tk 700-250.
 Für einen Einstich; komplett mit Ladevorrichtung und Konusteil.
For use with OP-Laparoscope tk 700-250.
For single puncture; complete with loading device and cone part.

Pour l'utilisation avec laparoscope tk 700-250.
 Pour une ponction; complet avec chargeur et conus.
Para la utilización con laparoscop tk 700-250.
Para una punción; completo con cargador y punta conica.

Per utilizzo con laparoscopia operativo tk 700-250.
 Per una incisione; completo di strumenti di carica e parte a cono.

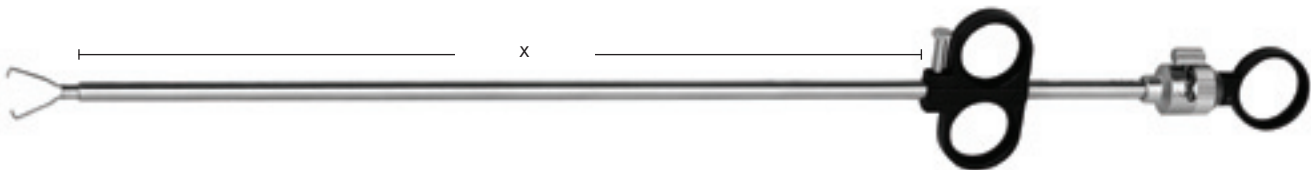

	x = 287 mm
Ø 6.5 mm - 20 Charr.	tk 791-185

Zur Anwendung mit einer regulären Trokarhülse (7 mm).
 Für den zweiten Einstich; komplett mit Ladevorrichtung und Konusteil.
For use with a regular trocar sheath (7 mm).
For second puncture; complete with loading device and cone part.

Pour l'utilisation avec un trocar standard (7 mm).
 Pour la deuxième ponction; complet avec chargeur et conus.
Para la utilización con un trocar estandard (7 mm).
Para segundo punción, completo con cargador y punta conica.

Per utilizzo con trocar normale (7 mm).
 Per due incisioni; completo di strumenti di carica e parte a cono.

tk 791-186	without CE mark
-------------------	------------------------

Plastikringe zur Ligation, autoklavierbar, Pack à 50 Stück
Plastic rings for ligation, autoclavable, package of 50 pieces

Anneaux en plastique pour ligation, autoclavable, paq. à 50 pcs.
Anillos de plastica para ligación, paq. a 50 pzas.

Anelli di plastica per legatura, autoclavabili, confezione di 50 pezzi

tk 791-187

Konusteil für tk 791-180 / tk 791-185
Cone part for tk 791-180 / tk 791-185

Conus pour tk 791-180 / tk 791-185
Punta conica para tk 791-180 / tk 791-185

Parte conica per tk 791-180 / tk 791-185

tk 791-189

Ladevorrichtung für tk 791-180 / tk 791-185
Loading device for tk 791-180 / tk 791-185

Chargeur pour tk 791-180 / tk 791-185
Cargador para tk 791-180 / tk 791-185

Caricatore per tk 791-180 / tk 791-185

Uterusmanipulator
Uterus manipulator

Manipulator utérin
Manipulador uterino
Manipolatore uterino



	tk 791-151	tk 791-152	tk 791-153	tk 791-154	tk 791-155	tk 791-156	tk 791-157
Manipulator <i>Manipulator</i> Manipulator <i>Manipulador</i> Manipolatore		Ø 3.0 x 45 mm	Ø 3.0 x 55 mm	Ø 3.2 x 34 mm	Ø 3.2 x 45 mm	Ø 8.0 x 80 mm	Ø 10.0 x 100 mm
tk 791-150	x	x	x	x	x	x	x

komplett
complete
complet
completo
completo

Instrumente
Instruments

Instruments
Instrumentos
Strumenti

Myombohrer

Myoma drill

Mèche pour myomes

Taladro para miomas

Fissatore per mioma



	x = 330 mm	x = 420 mm
Ø 5.0 mm	tk 791-170	tk 791-176

Arbeitslänge

Working length

Longueur de travail

Longitud de trabajo

Lunghezza operativa



	x = 330 mm	x = 420 mm
Ø 10.0 mm	tk 791-174	tk 791-175

Arbeitslänge

Working length

Longueur de travail

Longitud de trabajo

Lunghezza operativa

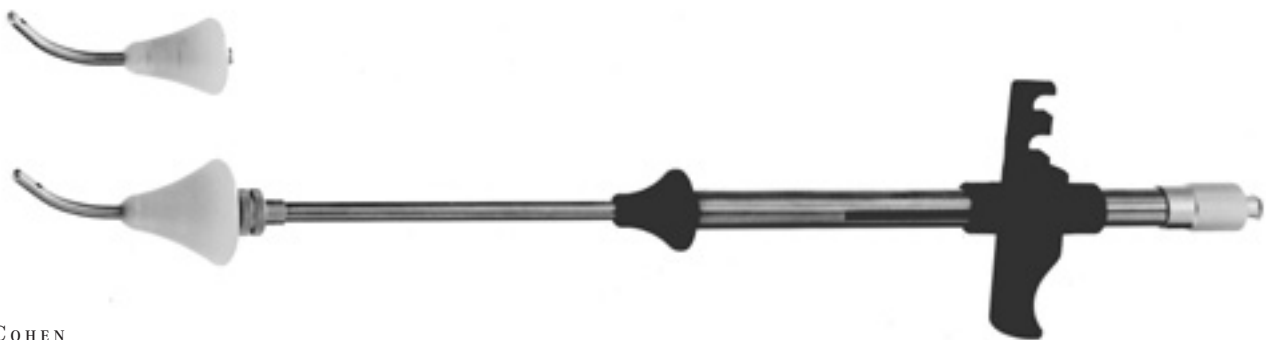

COHEN

tk 791-161

Intra-Uterin-Sonde mit 1 kleinen und 1 großen Portio-Kegelansatz

Intra-uterine probe with 1 small and 1 large cervical cone

Sonde intra utérin avec 1 petit et 1 grand adaptateur conique

Sonda intra-uterina con 1 pequeño y 1 grande adaptador conico

Sonda intra-uterina con un cono cervicale piccolo ed uno grande

Uterussonden
Uterus probes

Sondes utérinaires
Sondas para el útero
Sondas uterinas



VALLEIX

250 mm - 9¾" tk 34197-25

graduirt, mit Schieber
graduated, with slider
gradué, avec curseur
graduado, con cursor
graduato, con cursore



MARTIN

320 mm - 12½" tk 34198-32 tk 34199-32

graduirt	fest	biegsam
<i>graduated</i>	<i>rigid</i>	<i>malleable</i>
gradué	rigide	malléable
<i>graduado</i>	<i>rigido</i>	<i>maleable</i>
graduato	rigido	malleabile



SIMS

320 mm - 12½" tk 34200-32 tk 34201-32

graduirt	fest	biegsam
<i>graduated</i>	<i>rigid</i>	<i>malleable</i>
gradué	rigide	malléable
<i>graduado</i>	<i>rigido</i>	<i>maleable</i>
graduato	rigido	malleabile

Metallkatheter
Metal catheter

Cathéters métalliques
Catéteres metálicos
Cateteri di metallo

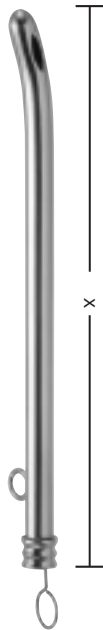

GUYON

		x = 150 mm
2 mm Ø	6 Charr./Fr.	tk 30410-06
2½ mm Ø	7 Charr./Fr.	tk 30410-07
2⅔ mm Ø	8 Charr./Fr.	tk 30410-08
3 mm Ø	9 Charr./Fr.	tk 30410-09
3⅓ mm Ø	10 Charr./Fr.	tk 30410-10
3⅔ mm Ø	11 Charr./Fr.	tk 30410-11
4 mm Ø	12 Charr./Fr.	tk 30410-12
4⅓ mm Ø	13 Charr./Fr.	tk 30410-13
4⅔ mm Ø	14 Charr./Fr.	tk 30410-14
5 mm Ø	15 Charr./Fr.	tk 30410-15
5⅓ mm Ø	16 Charr./Fr.	tk 30410-16
5⅔ mm Ø	17 Charr./Fr.	tk 30410-17
6 mm Ø	18 Charr./Fr.	tk 30410-18
6⅓ mm Ø	19 Charr./Fr.	tk 30410-19
6⅔ mm Ø	20 Charr./Fr.	tk 30410-20
7 mm Ø	21 Charr./Fr.	tk 30410-21
7⅓ mm Ø	22 Charr./Fr.	tk 30410-22
7⅔ mm Ø	23 Charr./Fr.	tk 30410-23
8 mm Ø	24 Charr./Fr.	tk 30410-24

Uterus-Dilatatoren
Uterine dilators

Dilateurs du col de l'utérus
Dilatadores uterinos
Dilatatori uterini



H E G A R

1.0 mm Ø	tk 34250-10
1.5 mm Ø	tk 34250-15
2.0 mm Ø	tk 34250-20
2.5 mm Ø	tk 34250-25
3.0 mm Ø	tk 34250-30
3.5 mm Ø	tk 34250-35
4.0 mm Ø	tk 34250-40
4.5 mm Ø	tk 34250-45
5.0 mm Ø	tk 34250-50
5.5 mm Ø	tk 34250-55
6.0 mm Ø	tk 34250-60
6.5 mm Ø	tk 34250-65
7.0 mm Ø	tk 34250-70
7.5 mm Ø	tk 34250-75
8.0 mm Ø	tk 34250-80
8.5 mm Ø	tk 34250-85
9.0 mm Ø	tk 34250-90
9.5 mm Ø	tk 34250-95

10.0 mm Ø	tk 34251-00
10.5 mm Ø	tk 34251-05
11.0 mm Ø	tk 34251-10
11.5 mm Ø	tk 34251-15
12.0 mm Ø	tk 34251-20
12.5 mm Ø	tk 34251-25
13.0 mm Ø	tk 34251-30
13.5 mm Ø	tk 34251-35
14.0 mm Ø	tk 34251-40
14.5 mm Ø	tk 34251-45
15.0 mm Ø	tk 34251-50
15.5 mm Ø	tk 34251-55
16.0 mm Ø	tk 34251-60
16.5 mm Ø	tk 34251-65
17.0 mm Ø	tk 34251-70
17.5 mm Ø	tk 34251-75
18.0 mm Ø	tk 34251-80
18.5 mm Ø	tk 34251-85
19.0 mm Ø	tk 34251-90
19.5 mm Ø	tk 34251-95

20.0 mm Ø	tk 34252-00
21.0 mm Ø	tk 34252-10
22.0 mm Ø	tk 34252-20
23.0 mm Ø	tk 34252-30
24.0 mm Ø	tk 34252-40
25.0 mm Ø	tk 34252-50
26.0 mm Ø	tk 34252-60
27.0 mm Ø	tk 34252-70
28.0 mm Ø	tk 34252-80
29.0 mm Ø	tk 34252-90
30.0 mm Ø	tk 34253-00

H E G A R

4 mm - 17 mm Ø	14	tk 34260-14
1 mm - 26 mm Ø	26	tk 34260-26

Stück per Satz	Satz, ohne Metalletui
<i>Pieces per set</i>	<i>Set, without metal case</i>
Pièces per jeu	Jeu, sans boîte en métal
<i>Piezas para juego</i>	<i>Juego, sin caja de metal</i>
Pezzi per serie	Serie, senza astuccio metallico

Uterus-Dilatatoren
Uterine dilators

Dilateurs du col de l'utérus
Dilatadores uterinos
Dilatatori uterini

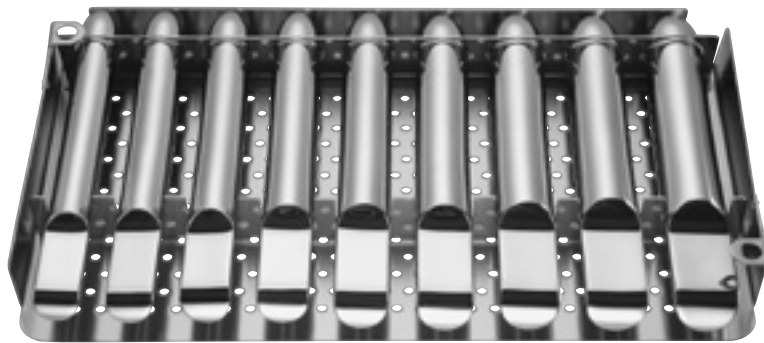

HEGAR

4 mm - 17 mm Ø	14	tk 34261-14
1 mm - 26 mm Ø	26	tk 34261-26

Stück per Satz	Satz, in Metalletui
<i>Pieces per set</i>	<i>Set, in metal case</i>
Pièces per jeu	Jeu, en boîte de métal
<i>Piezas para juego</i>	<i>Juego, en caja de metal</i>
Pezzi per serie	Serie, con astuccio metallico

Uterus-Dilatatoren
Uterine dilators

Dilateurs du col de l'utérus
Dilatadores uterinos
Dilatatori uterini



HEGAR

1 / 2 mm Ø	tk 34262-02
3 / 4 mm Ø	tk 34262-04
5 / 6 mm Ø	tk 34262-06
7 / 8 mm Ø	tk 34262-08
9 / 10 mm Ø	tk 34262-10
11 / 12 mm Ø	tk 34262-12
13 / 14 mm Ø	tk 34262-14
15 / 16 mm Ø	tk 34262-16
17 / 18 mm Ø	tk 34262-18
19 / 20 mm Ø	tk 34262-20
21 / 22 mm Ø	tk 34262-22
23 / 24 mm Ø	tk 34262-24
25 / 26 mm Ø	tk 34262-26

HEGAR

3 / 4 mm - 17 / 18 mm Ø	8	tk 34265-05
1 / 2 mm - 25 / 26 mm Ø	13	tk 34265-06

Stück per Satz Satz, allein
 Pièces per set Set, only
 Pièces per jeu Jeu, seul
 Piezas por juego Juego, solo
 Pezzi per serie Serie, solo



HEGAR

3 / 4 mm - 17 / 18 mm Ø	8	tk 34265-00	tk 34265-08
1 / 2 mm - 25 / 26 mm Ø	13	-	tk 34265-13

Stück per Satz Satz in Stoffrolltasche
 Pièces per set Set in canvas roll
 Pièces per jeu Jeu en poche de textile
 Piezas por juego Juego en bolsa de tela
 Pezzi per serie Serie in astuccio di tela

Satz, in Metalletui
 Set, in metal case
 Jeu, en boîte de métal
 Juego, en caja de metal
 Serie, in astuccio metallico

Biopsieküretten
Biopsy curettes

Curettes pour biopsie
Curetas para biopsía
Curette per biopsia



RANDALL

	4 mm Ø
240mm - 9½"	tk 34800-24



NOVAK

	4 mm Ø
230 mm - 9"	tk 34805-23

MINI-NOVAK

	235 mm - 9¼"
1 mm Ø	tk 34807-23
2 mm Ø	tk 34808-23
3 mm Ø	tk 34809-23



KEVORKIAN

300 mm - 12"	tk 34810-30	tk 34813-30
--------------	--------------------	--------------------

fest, ohne Korb
rigid, without basket
rigide, sans panier
rigida, sin cesta
rigida, senza cestino

fest, mit Korb
rigid, with basket
rigide, avec panier
rigida, con cesta
rigida, con cestino

tk 34811-30	tk 34812-30
--------------------	--------------------

biegsam, ohne Korb
malleable, without basket
malléable, sans panier
malleable, sin cesta
flessibile, senza cestino

biegsam, mit Korb
malleable, with basket
malléable, avec panier
malleable, con cesta
flessibile, con cestino



Endospekula | Endospéculums
 Endospecula | Endospéculos
 Endospecoli



KOGAN

240 mm - 9½" | tk 34153-24

mit Skalensperre und Stellschraube
 with scale-ratchet and fixation screw

avec crémaillère à échelle et vis à fixation
 con cremallera graduada y tornillo de fijación
 con cremagliera graduata e vite di fissaggio



KOGAN

240 mm - 9½"

tk 34154-24



KOGAN-MODIF.

280 mm - 11"

x = 4 mm y = 8 mm | tk 34150-01

x = 2 mm y = 4 mm | tk 34150-02

Hakenzangen
Uterine tenaculum forceps

Pinces pour le col d'utérus
Pinzas para coger el cuello del útero
Pinze per abbassare il collo dell'utero



BARRETT

180 mm - 7"

tk 34305-18



SCHROEDER

250 mm - 9³/₄"

tk 34310-25



POZZI

255 mm - 10"

tk 34311-26

Salpingograph
Salpingograph

Salpingographe
Salpingógrafo
Salpingografo

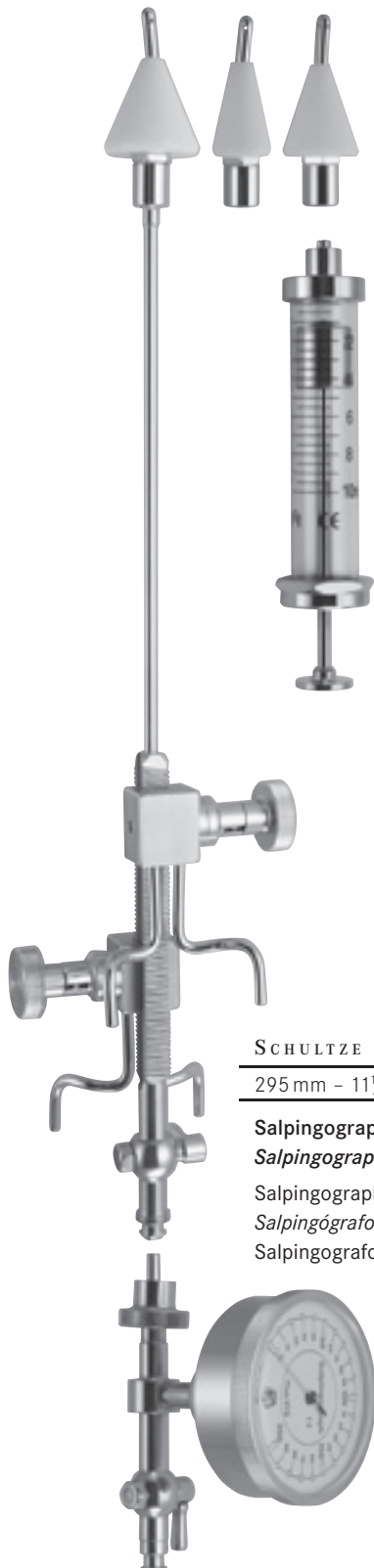

SCHULTZE

295 mm - 11½" tk 34880-00

Salpingograph, komplett im Holzetui
Salpingograph, complete in wooden case
Salpingographe, complet en etui de bois
Salpingógrafo, completo en caja de madera
Salpingografo, completo in astuccio di legno

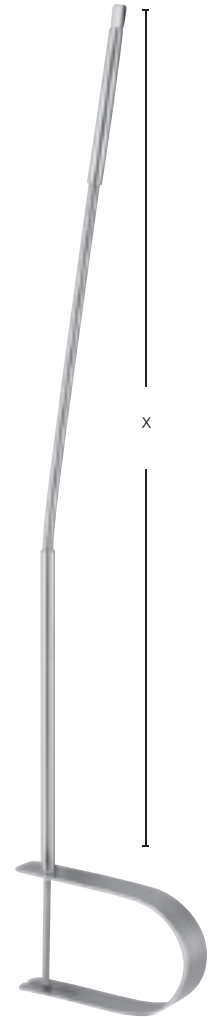

4 mm Ø
x = 230 mm - 9" tk 34872-00

Zange zum Entfernen von Spiralen
Spiral forceps hook for I.U.D. removings
Pince pour enlever des stérilets
Pinza para remover la espiral de esterilidad
Pinza per rimuovere la spirale

Zubehör
Accessories

Accessoires
Accesorios
Accessori



380 x 260 x 65 mm

tk 85109-01

Sterilisier Container mit Einsatz (für Resektoskopie Set ohne Instrumente)

Sterilisation container with insert (for resectoscopy set without instruments)

Contenaires pour stérilisation avec insert (pour résectoscopie sans instruments)

Contenedor para esterilización con inserto (para set de resectoscopia sin instrumentos)

Container per sterilizzazione con inserto (per set di resectoscopia senza strumenti)

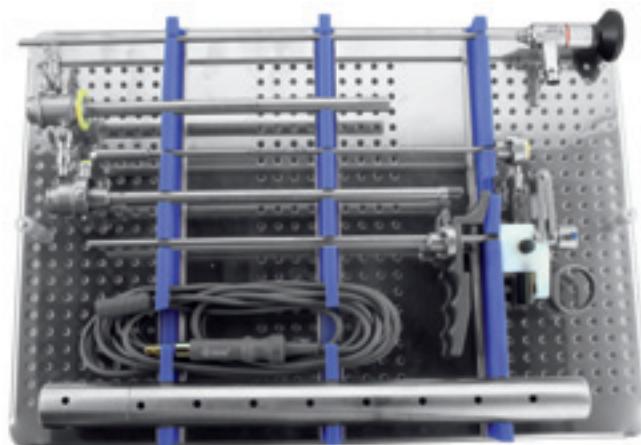

370 x 255 x 45 mm

tk 85109-02

Einsatz für Container tk 85109-01 (ohne Instrumente)

Insert for container tk 85109-01 (without instruments)

Insert pour conteneur tk 85109-01 (sans instruments)

Inserto para contenedor tk 85109-01 (sin instrumentos)

Inserto per container tk 85109-01 (senza strumenti)

Zubehör | Accessoires
Accessories | Accesorios
Accessori



500 ml	100 ml
tk 95000-00	tk 95100-00

TEKNO spezial Ölspray zur Instrumentenpflege
TEKNO special oil spray for surgical instruments
 TEKNO spray huileux pour des instruments
TEKNO spray de aceite para instrumentos
 TEKNO olio spray speciale per strumentario chirurgico



tk 790-399

LUER-Lock Schlauchverbindung mit Hahn
LUER-Lock tube connector with stopcock
 LUER-Lock raccord avec robinet
LUER-Lock conector para tubos con grifo
 LUER-Lock raccordo con rubinetto d'arresto



tk 790-398

LUER-Lock Schlauchverbindung
LUER-Lock tube connector
 LUER-Lock raccord
LUER-Lock conector para tubos
 LUER-Lock raccordo

**Zubehör
Accessories**

 Accessoires
 Accesorios
 Accessori

	30 ml	25 ml	15 ml
	tk 95000-50	tk 95000-51	tk 95000-52
Antibeschlagmittel <i>Antifog solution</i>	Durchstichflasche (steril) <i>Pierce bottle (sterile)</i>	Pipettenflasche <i>Pipette bottle</i>	Sprühflasche <i>Spray bottle</i>
Solution antibuée <i>Solución antiraho</i> Anti appannante	Bouteille perforée (stérile) <i>Botella perforada (estéril)</i> Bottiglia perforato (sterile)	Bouteille pipette <i>Botella con pipeta</i> Bottiglia con pipetta	Bouteille spray <i>Botella de spray</i> Bottiglia di spray



	tk 95011-00	tk 95011-02	tk 95012-00
LL-Verschlusschrauben <i>End screws for LL channels</i>	Kunststoff weiß <i>Plastic, white</i>	Kunststoff schwarz <i>Plastic, black</i>	Edelstahl <i>Stainless steel</i>
Vis pour connecteur LL <i>Tornillos para conexión LL</i> Tappi di chiusura LL	Plastifié, blanc <i>Plástico blanco</i> Plastica bianca	Plastifié, noir <i>Plástico negro</i> Plastica nere	Acier inoxydable <i>Acero inoxidable</i> Acciaio inossidabile

tk 95010-00

 Dichtungskappe, Silikon, (10 Stück)
Silicon cap, (10 pieces)
 Capuchon de silicon, (10 pièces.)
Capuchón de silicona, (10 piezas)
 Tappo in silicone, (10 pezzi)

tk 700-997

 Adapter für TEKNO Optiken zum Anschluss von
 TEKNO, Storz und Olympus Kaltlichtkabeln.
*Adaptor for TEKNO endoscopes to connect TEKNO,
 Storz, Olympus cold light cables.*
 Adaptateur pour connecter des optiques TEKNO
 avec des cables de lumière froide TEKNO, Storz, Olympus
*Adaptador para la conexión de las ópticas TEKNO
 con los cables de luz fría de TEKNO, Storz, Olympus*
 Adattatore per ottiche TEKNO per la connessione
 con cavi di luce fredda TEKNO, Storz ed Olympus

Zubehör
Accessories

Accessoires
Accesorios
Accessori

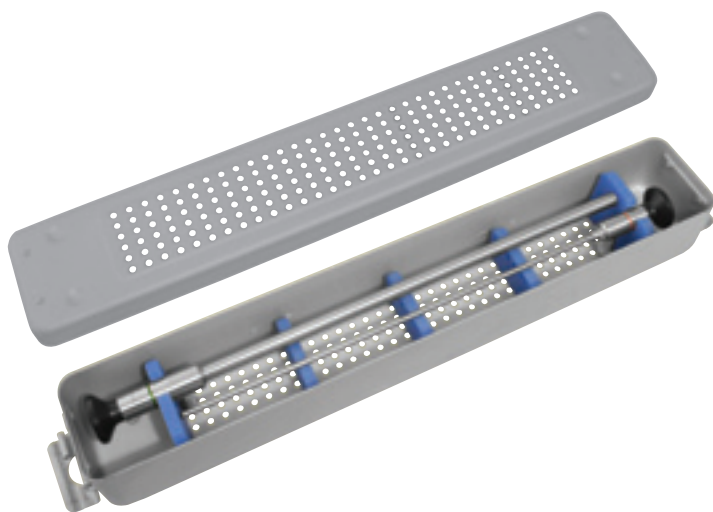

Perforierter Boden und Deckel, ohne Filter.
Silikonhalterung für zwei Endoskope.
*Perforated bottom and lid, without filter.
Silicon fittings for two endoscopes.*

Couvercle et fond perforés, sans filtres.
Pièces en silicone pour 2 optiques.
*Tapa y fondo perforados, sin filtros.
Piezas en silicona para 2 ópticas.
Coperchio e fondo perforato, senza filtri.
Sostegno di silicone per 2 ottiche.*

250 x 60 x 50 mm	■	tk 87280-2F-SI
250 x 60 x 50 mm	■	tk 87280-2F-YE
250 x 60 x 50 mm	■	tk 87280-2F-GR
250 x 60 x 50 mm	■	tk 87280-2F-BL
250 x 60 x 50 mm	■	tk 87280-2F-RE
250 x 60 x 50 mm	■	tk 87280-2F-BK

Deckelfarbe
Lid colour

Couleur du couvercle
Color de la tapa
Colore del coperchio

450 x 70 x 70 mm	■	tk 87290-2F-SI
450 x 70 x 70 mm	■	tk 87290-2F-YE
450 x 70 x 70 mm	■	tk 87290-2F-GR
450 x 70 x 70 mm	■	tk 87290-2F-BL
450 x 70 x 70 mm	■	tk 87290-2F-RE
450 x 70 x 70 mm	■	tk 87290-2F-BK

Deckelfarbe
Lid colour

Couleur du couvercle
Color de la tapa
Colore del coperchio



460 x 80 x 52 mm	tk 707-650
290 x 80 x 52 mm	tk 707-651

Siebkorb für Optiken > Ø 2,7 mm
Wire basket for endoscopes > Ø 2.7 mm

Panier pour optiques > Ø 2.7 mm
Cesta para ópticas > Ø 2.7 mm
Cestello per endoscopi con diametro > Ø 2.7 mm



tk 700-999

Autoklavierbare Schutzhülse für Endoskope bis Ø 5 mm, durch Zusammenstecken von 2 Hülsen erweiterbar für Urologie / Gynäkologie - Optiken
Autoclavable protection tube for endoscopes up to Ø 5 mm, assembling of two tubes will allow a protection for Urology / Gynaecology scopes

Gaines de protection autoclavables pour optiques jusqu'au 5 mm Ø. En combinant deux gaines, élargable pour des optiques d'urologie et gynécologie.
Vainas de protección autoclavables para ópticas fino a Ø 5 mm. Conectando dos vainas se pueden utilizar también para ópticas de Urología / Ginecología
Tubi di protezione autoclavabili per ottiche fino a 5 mm di diametro. L'assemblaggio di due tubi consentirà la protezione di ottiche per urologia / ginecologia

TEKNO-FLEX

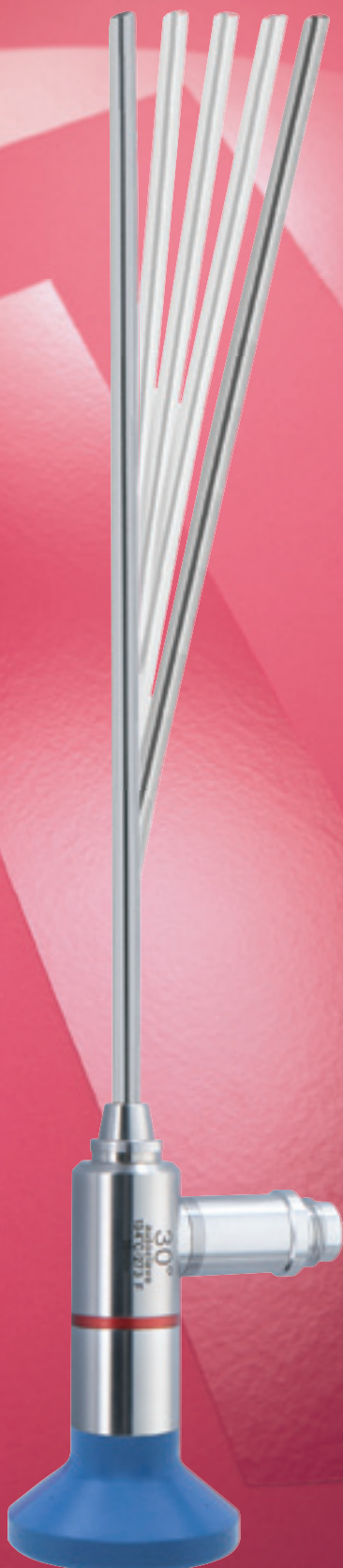

Die Vorteile von Tekno-Flex Endoskope (patentiert):

- weniger anfällig gegen äußere mechanische Einwirkungen, wie Verbiegen
- höhere Flexibilität im Vergleich zu Standard Endoskopen
- höhere Widerstandsfähigkeit (70% aller Reparaturen basieren auf gebrochenen Stablinsen, verursacht durch gebogene Schäfte)
- kratzsicheres Saphirglas am distalen Ende und am Okular
- korrekte Farbwiedergabe und gleichmäßige Bildschärfe
- 1 Jahr Garantie auf gebrochene Stablinsen
- Tekno-Flex Optiken sind durch den Zusatz "SF" gekennzeichnet

The advantages of Tekno-Flex endoscopes (patented):

- *the optical system is less sensitive to bending*
- *higher flexibility compared to standard rigid endoscopes*
- *higher robustness (70% of all repairing is due to broken rod-lenses caused by bent tubes)*
- *scratch-proof sapphire glass on the distal end and ocular side*
- *high resolution and contrast reproduction*
- *1 year warranty against broken rod-lenses*
- *Tekno-Flex scopes can be recognized by the suffix "SF"*

Les avantages des endoscopes Tekno-Flex (brevetés):

- haute résistance contre influences mécaniques
- meilleure souplesse comparé avec des endoscopes rigides
- meilleure résistance (70% de toutes réparations sont provoquées par des ruptures des lentilles cylindriques)
- verres distales et proximales en saphir
- reproduction parfaite des couleurs et profondeur de champ exceptionnel
- 1 an de garantie sur ruptures des lentilles cylindriques
- les optiques Teko-Flex peuvent être reconnues par l'annexe "SF"

Las ventajas de los endoscopios Tekno-Flex (patentados):

- *gran resistencia al estrés mecánico*
- *mayor flexibilidad en comparación a ópticas tradicionales*
- *mayor resistencia (70% de todas las reparaciones son debidas a roturas de lentes cilíndricas)*
- *las lentes distales y proximales son de zafiro de alta resistencia*
- *perfecta reproducción de color y extraordinaria profundidad de campo*
- *1 año de garantía sobre roturas de lentes cilíndricas*
- *las ópticas Tekno-Flex son reconocidos por el anexo "SF"*

I vantaggi degli endoscopi Tekno-Flex (brevettato):

- maggiore resistenza contro stress meccanico
- accetta una grande flessione rispetto ad ottiche tradizionali
- elevata robustezza (70% di tutte le riparazioni é dovuto a rotture delle rod-lenses)
- lenti distale e prossimale in zaffiro ad alta resistenza
- perfetta riproduzione dei colori e immagine a fuoco a tutto campo
- 1 anno di garanzia su rottura delle rod-lens
- le ottiche Tekno-Flex hanno un numero d'articolo con "SF" aggiunto

Nummernverzeichnis
Numerical index

Index numériques
Indice numerico

Indice dei numeri d'articolo

Art. No.	Page	Art. No.	Page	Art. No.	Page	Art. No.	Page
tk 700-059	30, 40	tk 790-175	25	tk 790-285	25	tk 791-049	15
tk 700-060	11	tk 790-176	25	tk 790-288	25	tk 791-050	9
tk 700-060SF	11	tk 790-177	25	tk 790-289	25	tk 791-051	9
tk 700-061	30, 40	tk 790-178	25	tk 790-300	31	tk 791-052	9
tk 700-062	11	tk 790-179	25	tk 790-305	31	tk 791-053	9
tk 700-062SF	11	tk 790-180	25	tk 790-308	31	tk 791-070	21
tk 700-063	11	tk 790-186	25	tk 790-309	31	tk 791-072	21
tk 700-063SF	11	tk 790-187	25	tk 790-310	26, 30, 40	tk 791-074	21
tk 700-064	30, 40	tk 790-189	25	tk 790-311	26, 30, 40	tk 791-076	21
tk 700-064SF	30, 40	tk 790-194	25	tk 790-312	26, 30, 40	tk 791-080	13
tk 700-065	30, 40	tk 790-196	24	tk 790-313	26, 30, 40	tk 791-081	13
tk 700-065SF	30, 40	tk 790-197	23	tk 790-315	34	tk 791-125	21
tk 700-066	30, 40	tk 790-198	23	tk 790-316	34	tk 791-127	21
tk 700-068	30, 40	tk 790-199	23	tk 790-317	34	tk 791-130	17
tk 700-068SF	30, 40	tk 790-200	24	tk 790-318	34, 35, 37	tk 791-131	17
tk 700-069	30, 40	tk 790-201	24	tk 790-320	35	tk 791-132	18
tk 700-070	17	tk 790-202	23	tk 790-321	35	tk 791-133	18
tk 700-070SF	17	tk 790-203	23	tk 790-322	35	tk 791-134	20
tk 700-072	17	tk 790-204	23	tk 790-323	28, 34, 35, 37	tk 791-136	20
tk 700-072SF	17	tk 790-205	23	tk 790-324	34, 37	tk 791-137	18
tk 700-073	5, 17	tk 790-206	23	tk 790-327	37	tk 791-138	18
tk 700-073SF	17	tk 790-207	23	tk 790-330	34	tk 791-140	20
tk 700-074	30, 40	tk 790-216	24	tk 790-331	34	tk 791-142	22
tk 700-074SF	30, 40	tk 790-217	23	tk 790-332	34	tk 791-143	22
tk 700-075	30, 40	tk 790-218	23	tk 790-341	34	tk 791-144	22
tk 700-075SF	30, 40	tk 790-219	23	tk 790-343	34	tk 791-150	51
tk 700-077	17	tk 790-220	24	tk 790-344	34	tk 791-151	51
tk 700-077SF	17	tk 790-221	24	tk 790-345	37	tk 791-152	51
tk 700-078	30, 40	tk 790-222	23	tk 790-374	33	tk 791-153	51
tk 700-078SF	30, 40	tk 790-223	23	tk 790-398	63	tk 791-154	51
tk 700-079	30, 40	tk 790-224	23	tk 790-399	63	tk 791-155	51
tk 700-079SF	30, 40	tk 790-225	23	tk 790-482	25	tk 791-156	51
tk 700-220	8	tk 790-226	23	tk 790-483	25	tk 791-157	51
tk 700-221	8	tk 790-227	23	tk 790-484	25	tk 791-161	52
tk 700-250	49	tk 790-236	24	tk 790-485	25	tk 791-170	52
tk 700-251	49	tk 790-237	23	tk 790-486	25	tk 791-174	52
tk 700-255	49	tk 790-238	23	tk 790-487	25	tk 791-175	52
tk 700-256	49	tk 790-239	23	tk 790-488	25	tk 791-176	52
tk 700-999	65	tk 790-240	24	tk 790-490	35	tk 791-180	50
tk 707-300	26	tk 790-241	24	tk 790-491	35	tk 791-185	50
tk 707-301	26	tk 790-242	23	tk 790-492	35	tk 791-186	50
tk 707-302	26	tk 790-243	23	tk 790-495	25	tk 791-187	50
tk 707-303	26	tk 790-244	23	tk 790-496	25	tk 791-189	50
tk 707-330	26	tk 790-245	23	tk 790-498	37	tk 791-250	8
tk 707-331	26	tk 790-246	23	tk 790-726	37	tk 791-251	8
tk 707-332	26	tk 790-247	23	tk 790-727	37	tk 791-252	11
tk 707-333	26	tk 790-250	24	tk 791-024	13	tk 791-253	11
tk 707-350	41	tk 790-251	24	tk 791-026	13	tk 791-256	17
tk 707-650	65	tk 790-255	24	tk 791-030	12	tk 791-257	11
tk 707-651	65	tk 790-256	24	tk 791-031	12	tk 791-258	8
tk 790-035	5	tk 790-258	24	tk 791-032	12	tk 791-350	32
tk 790-150	25	tk 790-260	24	tk 791-033	12	tk 791-351	32
tk 790-151	25	tk 790-262	24	tk 791-041	14	tk 791-352	32
tk 790-169	25	tk 790-263	24	tk 791-042	10	tk 791-353	32
tk 790-170	25	tk 790-264	24	tk 791-043	19	tk 791-354	33
tk 790-171	25	tk 790-280	25	tk 791-045	16	tk 791-355	33
tk 790-172	25	tk 790-281	25	tk 791-046	16	tk 791-357	32
tk 790-173	25	tk 790-282	25	tk 791-047	15	tk 791-358	32
tk 790-174	25	tk 790-284	25	tk 791-048	15	tk 791-359	33

Nummernverzeichnis
Numerical index

Index numériques
Indice numerico
Indice dei numeri d'articolo

Art. No.	Page	Art. No.	Page	Art. No.	Page	Art. No.	Page
tk 791-363	33	tk 30410-07	54	tk 34251-70	55	tk 87280-2F-SI	65
tk 791-365	33	tk 30410-08	54	tk 34251-75	55	tk 87280-2F-YE	65
tk 791-367	33	tk 30410-09	54	tk 34251-80	55	tk 87290-2F-BK	65
tk 791-420	32	tk 30410-10	54	tk 34251-85	55	tk 87290-2F-BL	65
tk 791-421	32	tk 30410-11	54	tk 34251-90	55	tk 87290-2F-GR	65
tk 791-422	33	tk 30410-12	54	tk 34251-95	55	tk 87290-2F-RE	65
tk 791-423	33	tk 30410-13	54	tk 34252-00	55	tk 87290-2F-SI	65
tk 791-424	32	tk 30410-14	54	tk 34252-10	55	tk 87290-2F-YE	65
tk 791-450	32	tk 30410-15	54	tk 34252-20	55		
tk 791-451	32	tk 30410-16	54	tk 34252-30	55		
tk 791-452	32	tk 30410-17	54	tk 34252-40	55		
tk 791-453	32	tk 30410-18	54	tk 34252-50	55		
tk 791-454	33	tk 30410-19	54	tk 34252-60	55		
tk 791-455	33	tk 30410-20	54	tk 34252-70	55		
tk 791-457	32	tk 30410-21	54	tk 34252-80	55		
tk 791-458	32	tk 30410-22	54	tk 34252-90	55		
tk 791-463	33	tk 30410-23	54	tk 34253-00	55		
tk 791-465	33	tk 30410-24	54	tk 34260-14	55		
tk 791-467	33	tk 34150-01	59	tk 34260-26	55		
tk 799-300	41	tk 34150-02	59	tk 34261-14	56		
tk 799-305	41	tk 34153-24	59	tk 34261-26	56		
tk 799-308	41	tk 34154-24	59	tk 34262-02	57		
tk 799-309	41	tk 34197-25	53	tk 34262-04	57		
tk 799-310	44	tk 34198-32	53	tk 34262-06	57		
tk 799-311	44	tk 34199-32	53	tk 34262-08	57		
tk 799-312	44	tk 34200-32	53	tk 34262-10	57		
tk 799-313	44, 48	tk 34201-32	53	tk 34262-12	57		
tk 799-320	45	tk 34250-10	55	tk 34262-14	57		
tk 799-321	45, 47	tk 34250-15	55	tk 34262-16	57		
tk 799-322	45	tk 34250-20	55	tk 34262-18	57		
tk 799-323	48	tk 34250-25	55	tk 34262-20	57		
tk 799-323	44, 45, 46, 47	tk 34250-30	55	tk 34262-22	57		
tk 799-324	47	tk 34250-35	55	tk 34262-24	57		
tk 799-326	48	tk 34250-40	55	tk 34262-26	57		
tk 799-327	48	tk 34250-45	55	tk 34265-00	57		
tk 799-328	47	tk 34250-50	55	tk 34265-05	57		
tk 799-330	44	tk 34250-55	55	tk 34265-06	57		
tk 799-331	44, 46	tk 34250-60	55	tk 34265-08	57		
tk 799-332	44	tk 34250-65	55	tk 34265-13	57		
tk 799-333	46	tk 34250-70	55	tk 34305-18	60		
tk 799-335	46	tk 34250-75	55	tk 34310-25	60		
tk 799-345	48	tk 34250-80	55	tk 34311-26	60		
tk 799-350	43	tk 34250-85	55	tk 34800-24	58		
tk 799-351	42	tk 34250-90	55	tk 34805-23	58		
tk 799-352	42	tk 34250-95	55	tk 34807-23	58		
tk 799-353	42	tk 34251-00	55	tk 34808-23	58		
tk 799-354	43	tk 34251-05	55	tk 34809-23	58		
tk 799-355	43	tk 34251-10	55	tk 34810-30	58		
tk 799-356	43	tk 34251-15	55	tk 34811-30	58		
tk 799-357	43	tk 34251-20	55	tk 34812-30	58		
tk 799-360	43	tk 34251-25	55	tk 34813-30	58		
tk 799-361	42	tk 34251-30	55	tk 34872-00	61		
tk 799-362	42	tk 34251-35	55	tk 34880-00	61		
tk 799-365	43	tk 34251-40	55	tk 85109-01	62		
tk 799-366	43	tk 34251-45	55	tk 85109-02	62		
tk 799-371	42	tk 34251-50	55	tk 87280-2F-BK	65		
tk 799-372	42	tk 34251-55	55	tk 87280-2F-BL	65		
tk 799-373	42	tk 34251-60	55	tk 87280-2F-GR	65		
tk 30410-06	54	tk 34251-65	55	tk 87280-2F-RE	65		

Wichtige Hinweise

Dieser Katalog bleibt Eigentum der Firma TEKNO-MEDICAL Optik-Chirurgie GmbH, auch wenn dafür eine Schutzgebühr bezahlt wurde. Er kann von uns jederzeit zurückgefordert werden, wenn er gegen unsere Interessen und nicht zum Vertrieb und Einkauf von TEKNO Produkten verwendet wird. Auch behalten wir uns in solch einem Falle weitergehende Maßnahmen vor.

Der Nachdruck oder Kopieren dieses Kataloges – im Gesamten oder auch nur auszugsweise – ist ohne unsere schriftliche Genehmigung verboten.

Modelländerungen vorbehalten. Gedruckt in der Bundesrepublik Deutschland

Important notice

This catalogue remains property of TEKNO-MEDICAL Optik-Chirurgie GmbH even if we have asked for a lending fee or charges. We can at any time recall the catalogue, in case that it has been not used according to our interests, i.e. sale or purchase of TEKNO products. We preserve the right for further steps in that case.

Reproduction or copying of this catalogue in whole or in parts is forbidden without our written permission.

Patterns are subject to change. Printed in Germany

Indications importantes

Ce catalogue reste la propriété de TEKNO-MEDICAL Optik-Chirurgie GmbH, même si nous avons demandé le paiement d'une taxe de protection. Nous pouvons demander le retour du catalogue dans le cas où celui-ci n'est pas utilisé conformément à nos intérêts, pour la vente ou l'achat de nos produits. Dans ce cas nous nous réservons le droit de mener des actions juridiques.

La reproduction ou la copie totale ou partielle de ce catalogue est interdite sans notre accord écrit.

Sous réserve des modifications techniques. Imprimé en Allemagne

Avisos importantes

Este catálogo es propiedad de TEKNO-MEDICAL Optik-Chirurgie GmbH, aún en el caso de haber abonado por él una tasa de colaboración. Podemos solicitar la devolución del catálogo en caso de que no sea utilizado para la compra o venta de nuestros productos. En este caso nos reservamos el derecho de tomar medidas jurídicas.

La reproducción o copia total o parcial de este catálogo esta prohibido sin nuestro consentimiento escrito.

Salvo modificaciones técnicas. Impreso en la República Federal de Alemania

Avvertenze importanti

Questo catalogo rimane proprietà della TEKNO-MEDICAL Optik-Chirurgie GmbH, anche se è stato rilasciato gratuitamente o contro pagamento. Possiamo in ogni momento richiederlo indietro, in caso non stato usato in accordo con i nostri interessi (acquisto e vendita dei prodotti TEKNO-Medical). Ci riserviamo in questo caso il diritto di prendere ulteriori provvedimenti.

La copia o la riproduzione di questo catalogo in parte o nella sua totalità è vietata senza il nostro permesso scritto.

Ci riserviamo la facoltà di cambiamenti nei modelli. Stampato in Germania



TEKNO-MEDICAL Optik-Chirurgie GmbH

Sattlerstrasse 11 · 78532 Tuttlingen, Germany

Telefon +49 (74 61) 17 01-0 · Fax +49 (74 61) 17 01-50

mail@tekno-medical.com · www.tekno-medical.com

© 07.2011 - TEKNO-MEDICAL Optik-Chirurgie GmbH

TEKNO is a registered trademark of TEKNO-MEDICAL Optik-Chirurgie GmbH