



D E N T A L

Zahnärztliche Instrumente
Dental Instruments

Instrumentes dentaires
Instrumental dental
Strumenti dentali





Hinweis: Auf Grund der Verkleinerung des Katalogformats werden alle Abbildungen inklusive Nebenabbildungen verkleinert dargestellt.

Notice: *Due to the reduction of the catalogue format, all illustrations including the details are illustrated in reduced scale.*

Avis: A cause de la réduction du format du catalogue, toutes illustrations et les détails sont illustrés en taille réduite.

Nota: *Debido a la reducción del formato del catálogo, todas ilustraciones inclusive los detalles son reproducidos en tamaño reducido.*

Nota: Le immagini illustrate comprese le immagini in aggiuntiva, vengono illustrate in modo ridotto a causa del formato ridotto del nostro catalogo.



Instrumente für den Dentalbereich

Solutions for the dental field

Solutions pour le sector dentaire

Soluciones para el sector de dental

Soluzioni per il settore dentale





Die Marke für beste Qualität

The brand for superior quality

La marque pour la qualité supérieur

La marca para la calidad superior

Il marchio per una qualità superiore

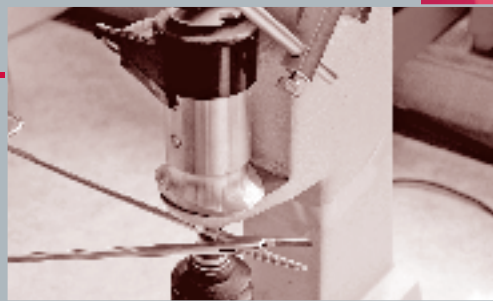



Medical, an

Medical, an

Die Firma TEKNO-MEDICAL Optik-Chirurgie GmbH wurde im April 1976 durch Herrn Bruno Mattes gegründet und wird heute als Familien-Unternehmen geführt. Durch die qualifizierte Arbeit der Mitarbeiter und die hohe Qualität der Produkte und Dienstleistungen konnte TEKNO-MEDICAL ein stetiges Wachstum vollziehen. Dies bedingte bereits im Jahr 1982 den ersten Bauabschnitt des heutigen Firmengebäudes in Tuttlingen-Nendingen, dem oft zitierten „Weltzentrum der Medizintechnik“. Im Jahre 1990 erfolgt die Gründung einer eigenen Produktionsstätte, welche heute zu einem der modernsten und leistungsfähigsten Fertigungsbetriebe herangewachsen ist.



TEKNO-MEDICAL Optik-Chirurgie GmbH has been founded in April 1976 by Mr. Bruno Mattes and is until today a private family-run company. Due to the qualified employees and the high quality standard of the products and services, TEKNO-MEDICAL could achieve a steady growth. This led in 1982 to the first section of the actual building in Tuttlingen-Nendingen, the world center for surgical industry. In 1990 our own production plant was founded, which is nowadays one of the most modern and efficient manufacturing facilities.



La société TEKNO-MEDICAL Optik-Chirurgie GmbH a été fondée en avril 1976 par Monsieur Bruno Mattes et est une PME familiale allemande. Grâce à l'engagement de nos employés qualifiés et à la qualité élevée de nos produits et services, TEKNO-MEDICAL a pu réaliser une croissance permanente. Cela nous a permis d'entreprendre dès 1982 la construction de notre premier bâtiment à Tuttlingen-Nendingen, le centre mondial de l'industrie médicale. En 1990, nous avons créé notre propre centre de production, qui est devenu une entreprise moderne et performante.



La empresa TEKNO-MEDICAL Optik-Chirurgie GmbH fue fundada en abril del 1976 por el Sr. Bruno Mattes y es hasta ahora una empresa familiar. El trabajo cualificado de nuestros empleados junto con la alta calidad de nuestros productos y servicios forman la base de nuestro crecimiento continuo. Eso llevó ya en el año 1982 a la construcción del primero de los edificios actuales en Tuttlingen-Nendingen, llamado centro mundial de la industria para instrumentos quirúrgicos. En el año 1990 se efectuó la fundación de nuestra propia empresa de producción, que es ahora una empresa moderna y eficiente.



La TEKNO-MEDICAL Optik-Chirurgie GmbH è stata fondata nell' aprile 1976 dal sig. Bruno Mattes, ed è tuttora una compagnia privata gestita dalla famiglia. Grazie a personale qualificato ed ad un elevato standard di qualità del prodotto e del servizio, la TEKNO-MEDICAL può vantare una crescita costante. Ciò porta nel 1982 alla costruzione della prima sezione dell'attuale fabbricato in Tuttlingen-Nendingen, il centro mondiale dell'industria chirurgica. Nel 1990 è stata fondata la propria fabbrica che è oggi uno dei più moderni ed efficienti impianti di produzione.





Die Qualität unserer Produkte war uns schon immer eine Herzensangelegenheit. Daher war es für uns auch selbstverständlich bei der Einführung der ISO-Zertifizierung zu den ersten Firmen zu gehören, welche erfolgreich zertifiziert wurden und ihre Instrumente mit der CE-Kennzeichnung versehen durften. TEKNO-MEDICAL ist zudem von der FDA geprüft und dadurch in der Lage die Produkte auch in die USA zu exportieren. Im Jahr 2013 wurde das Logistikgebäude erweitert. Dort sind nun das umfangreiche und gut bestückte Lager sowie die Qualitätskontrolle untergebracht. Gleichzeitig wurde das alte Bürogebäude vergrößert, wo jetzt der neue Ausstellungsraum und moderne Besprechungszimmer das stetige Wachstum des Unternehmens und seine Präsenz im neuen Millennium symbolisieren.



The quality of our products has always been and will always be our most important issue, that is what our brand name stands for. Therefore it was obvious for TEKNO-MEDICAL to be among the first companies who achieved the ISO-certification and who were allowed to mark their products with the CE-mark. In addition to that, TEKNO-MEDICAL is approved by the FDA and so allowed to export its products to the United States of America. In 2013 TEKNO-MEDICAL expanded the logistic centre, which now contains a huge and fully equipped stock and a quality control department. At the same time, the older part of the building has been reconstructed, where now a new show room and modern conference rooms symbolize the steady growth of the company and its presence in the new millennium.



La qualité de nos produits reste toujours notre principal but. C'est pourquoi il nous semble évident d'être parmi les premières entreprises à avoir passé avec succès les certifications ISO, permettant de marquer nos instruments avec la mention «CE». TEKNO-MEDICAL est de plus certifiée par la FDA et par conséquent est en mesure de pouvoir exporter ses produits aux Etats Unis. En 2013 un bâtiment qui contient aujourd'hui la plus grande partie de notre stock et le service de contrôle qualité a été élargi. Nous disposons également de nouvelles salles d'exposition et de de réunion. Cela marque une étape de plus dans l'histoire de l'entreprise pour le maintien du succès de TEKNO-MEDICAL dans le siècle à venir.



La calidad de nuestros productos fue siempre nuestro objetivo. Fue una evidencia al estar entre las primeras empresas que han aprobados con éxito las certificaciones ISO y que han obtenido el marcado CE de sus productos. TEKNO-MEDICAL esta además certificado por la FDA y por consiguiente tiene la posibilidad de exportar sus productos a los EEUU. En 2013 el edificio, que contiene ahora el centro logístico, el almacén y el servicio de control de calidad fue ampliado. Eso, junto con las nuevas salas de exposición y de reunión, representa un hito suplementario en la historia de nuestra empresa para la continuidad eficaz de TEKNO-MEDICAL en el nuevo siglo.



La qualità dei nostri prodotti è sempre stata e sempre sarà il nostro principale interesse, ed è il motivo stesso dell'esistenza del nostro marchio. Quindi è stato naturale per la TEKNO-MEDICAL essere tra le prime aziende a ricevere la certificazione ISO e a cui è stato concesso di marciare i propri prodotti con il marchio CE. Oltre a ciò TEKNO-MEDICAL ha l'approvazione dell'FDA ed è così autorizzata ad esportare i propri prodotti negli Stati Uniti d'America. Nel 2013 la TEKNO-MEDICAL ha costruito un nuovo centro logistico, che ora ospita un enorme e completo magazzino ed il dipartimento controllo qualità. Allo stesso tempo la parte più vecchia del fabbricato è stata ristrutturata ed in essa una nuova sala espositiva ed una moderna sala conferenze simboleggiano la costante crescita della compagnia e la sua presenza nel nuovo millennio.





TEKNO-MEDICAL GmbH verfügt heute über ein umfangreiches Vertriebsprogramm das nahezu alle Bereiche der Medizintechnik abdeckt und ist in über 100 Ländern vertreten. Sonderanfertigungen für unsere Kunden gehören dabei ebenso zu unseren Leistungen, wie die kompetente Betreuung bei Projektgeschäften. Für den Dental-Bereich bietet TEKNO-MEDICAL GmbH ein modernes, attraktives Instrumentenprogramm an, das sich in diesem Katalog widerspiegelt. Modernste Kommunikationsmittel unterstützen unser Vertriebsteam bei der täglichen Arbeit. Durch Schulungen und Weiterbildung erhalten unsere Mitarbeiter fachliche und sprachliche Kompetenz um unsere Kunden bestens bedienen zu können.



Today, TEKNO-MEDICAL GmbH possesses a wide range of products that nearly covers the entire medical field and which is distributed in more than 100 countries worldwide. Special designs for certain customers are also part of our services as well as qualified support for complete projects. For the dental field, TEKNO-MEDICAL GmbH offers a modern and attractive range of instruments which is presented in this catalogue. Modern communication facilities support our staff's daily work. Permanent training of our staff guarantee the professional and linguistic skills for the perfect service for our customers.



TEKNO-MEDICAL GmbH offre actuellement un programme étendu qui couvre presque tous les domaines médicaux et assure la distribution dans plus de 100 pays du monde. La production spéciale et l'assistance de nos clients lors de grands projets font également partie de notre travail. Pour le secteur dentaire TEKNO-MEDICAL GmbH offre un programme moderne et attractif, représenté dans ce catalogue. Des moyens de communication modernes assistent notre service de vente dans son travail quotidien. La formation continue interne garantit des compétences professionnelles et linguistiques de nos employés pour un service parfait pour nos clients.









TEKNO-MEDICAL GmbH dispone hoy día de un gran surtido de productos para casi todos los sectores médicos y esta representada en mas que 100 países del mundo. Fabricaciones especiales y la asistencia competente para nuestros clientes en proyectos grandes son también parte de nuestro trabajo. En el sector dental, TEKNO-MEDICAL GmbH oferta un programa de instrumentos moderno y atractivo, presentado en etse catálogo. Medios de comunicación modernos apoyan nuestro servicio de ventas en su trabajo cotidiano. Formaciones permanentes internos garantizan competencias profesionaels y lingüísticas de nuestros colaboradores para un servicio perfecto para nuestros clientes.





Oggi la TEKNO-MEDICAL GmbH produce una vasta gamma di prodotti che coprono quasi l'intero settore chirurgico e che sono distribuiti in oltre 100 paesi nel mondo. Speciali design per alcuni clienti sono anche parte del nostro servizio così come un supporto qualificato per l'intera progettazione. Tekno Medical GmbH offre un programma moderno, attrattivo di strumenti dentali, il quale si rispecchia in questo catalogo. Un magazzino ben assortito garantisce una fornitura veloce. Sistemi di comunicazione più moderni via modem e tecnologia informatica supportono il lavoro quotidiano del ns. staff. Costanti corsi di aggiornamento e trasmissione interna del "know how" garantiscono una competenza professionale ai massimi livelli. La conoscenza e l'utilizzo delle lingue straniere sono una parte significativa del nostro servizio cliente.



 <p>1</p>	<p>Diagnostik <i>Diagnostic</i> Diagnostic <i>Diagnóstico</i> Diagnostica</p>	15
 <p>2</p>	<p>Paradontologie, nicht chirurgisch <i>Periodontology, not surgical</i> Paradontologie, non chirurgicale <i>Paradontología, no quirúrgica</i> Strumenti per parodontologia</p>	23
 <p>3</p>	<p>Parodontal Chirurgie <i>Periodontal surgery</i> Paradontologie chirurgicale <i>Paradontología quirúrgica</i> Chirurgia parodontale</p>	45
 <p>4</p>	<p>Endodontie <i>Endodontic</i> Endodontie <i>Endodoncia</i> Endodonzia</p>	55
 <p>5</p>	<p>Extraktion <i>Extraction</i> Extraction <i>Extracción</i> Estrazione</p>	63
 <p>6</p>	<p>Konservierende Behandlung <i>Conserving treatment</i> Traitement conservant <i>Tratamiento conservando</i> Trattamento conservativo</p>	117
 <p>7</p>	<p>Hard- / Weichgewebechirurgie <i>Hard and soft tissue surgery</i> Chirurgie pour le tissu dur et moux Cirugía para el <i>tejido duro y blando</i> Chirurgia dei tessuti duri e morbidi</p>	135

Inhalt	Contenu
Content	Indice
	Indice

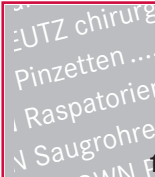
 8	Prothetik <i>Prothodontics</i> Prothèse <i>Prótesis</i> Prothetica	217
 9	Orthodontie <i>Orthodontics</i> Orthodontie <i>Ortodontia</i> Ortodontia	229
 10	Praxisorganisation <i>Practice Organization</i> Organisation du cabinet <i>Organizacion del consultario</i> Organizzazione dello studio	241
 11	Instrumentensätze <i>Instrument sets</i> Jeux d'instruments <i>Juegos de instrumentos</i> Set di strumenti	253
 12	Nummernverzeichnis <i>Numerical index</i> Index des numéros de référence <i>Indice numerico</i> Indice dei numeri d'articolo	267
 13	Inhaltsverzeichnis <i>Index</i> Table des matières <i>Indice</i> Indice	275

Reinigung, Sterilisation und Pflege
Cleaning, sterilization, instrument maintenance

Nettoyage, stérilisation, maintenance
Limpieza, esterilización, mantenimiento
Pulitura, sterilizzazione, manutenzione

Vor jeder Sterilisation sind die Instrumente sorgfältig von Hand in einem Desinfektionsbad und/oder Ultraschall-Reinigungsgerät bzw. Thermodesinfektor zu reinigen. Dabei müssen die Anweisungen des Herstellers strikt eingehalten werden.

- nur geeignete Reinigungsmittel und Desinfektionslösungen unter Einhaltung der Dosierungsvorschriften verwenden
- Reinigungsmittel mit Chlor- bzw. chloridhaltigen Substanzen sowie entsprechende Verbindungen der anderen Halogenide (Fluor, Jod, Brom) dürfen unter gar keinen Umständen benutzt werden.
- Instrumente mit Gelenken oder Buchsen (bzw. Zangen, Scheren, Nadelhalter) sollten immer im geöffneten Zustand gereinigt und sterilisiert werden.
- Instrumente und Geräte aus Aluminium dürfen nicht in den Thermodesinfektor oder in das Ultraschallbad gelegt werden. Bei der Reinigung bitte ausschließlich aluminiumgeeignetes Reinigungs- und Desinfektionsmittel verwenden.
- Nach der Reinigung ist das Instrumentarium gründlich und am besten mit demineralisiertem Wasser zu spülen. Das demineralisierte Wasser soll hierbei das am Instrument nach der Reinigung verbleibende Reinigungsmittelgemisch entfernen.
- Beläge und Verkrustungen sind mit einer weichen Bürste (keine Metallbürste) zu entfernen. Solche Rückstände können während der Sterilisation jederzeit zu Korrosion oder anderen Beschädigungen an den Instrumenten führen.
- Bevor Sie die Instrumente dem Sterilisationsprozess zuführen, müssen die Instrumente absolut trocken sein.
- Als sichere Sterilisiermethode empfehlen wir ausschließlich Dampfsterilisation. Die Anwendung jeder anderen Methode erfolgt auf eigene Verantwortung. Bei Heißluftsterilisation darauf achten, dass 180° C nicht überschritten werden, da sonst mit nicht mehr entfernbaren Verfärbungen und Härteabfall der Instrumente gerechnet werden muss.
- Instrumente aus rostfreiem Edelstahl dürfen keinesfalls mit anderen Metallen oder Materialien beim Sterilisationsprozess zusammen gelegt werden. Bei Missachtung können Oxydationsflecken auf dem Instrumentarium entstehen.
- Sterilisierte Instrumente müssen trocken, staubfrei und nicht in Reichweite von chemischen Produkten gelagert werden. Vermeiden Sie am Lagerort unbedingt größere Temperaturschwankungen

All instruments have to be cleaned carefully by hand or in disinfection or ultrasonic equipment. Following instructions from the manufacturer have to be kept:

- *Use only adequate cleaning and disinfection supplies under compliance of the dosage instruction*
- *Do not use cleaning supplies with chloric substances as well as accordant chemical bonds of other halogens (fluorine, iodine, bromine)*
- *Instruments with hinges or connectors (like forceps, scissors, or needle holders) always should be cleaned and sterilized in open position.*
- *nstruments and equipment made of aluminum may not be put in the ultrasonic bath or in the disinfectant. Use only aluminum adapted cleaning and disinfection supplies.*
- *Thoroughly rinse the instruments with demineralized water after cleaning. The demineralized water should remove the remaining cleaning supplies from the instruments*
- *Sticking residues and crusts should be removed with a soft brush (no metal brush). Such remainder can generate corrosion or other damages on the instruments during sterilization*
- *Instruments have absolutely to be dry before they are brought into the sterilization process*
- *As safe sterilisation method we recommend only autoclaving, every other method is applied exclusively at the user´s responsibility. If hot air sterilisation is used, make sure that temperature does not exceed 180° C, because a higher temperature can lead to non-removable discolorations and to a loss in hardness of the instruments.*
- *Instruments made of stainless steel may not be brought together with other metals or materials during the sterilization process. If this instruction is disregarded, oxidation spots can occur.*
- *Sterilized instruments have to be dry and dustfree. They may not be stored in reach of chemical products. Do absolutely prevent larger fluctuation of temperature in the storage location*



Diagnostik | Diagnostic
Diagnostic | *Diagnóstico*
Diagnostica



Mundspiegel und -griffe
Mouth mirrors and handles

Miroirs à bouche et manches
Espejos de boca y mangos
Specchietti per bocca e manici

Packung à 12 Stück
Box of 12 pcs.



22 mm Fig. 4	tk 70000-22	tk 70001-22	tk 70002-22
24 mm Fig. 5	tk 70000-24	tk 70001-24	tk 70002-24
26 mm Fig. 6	tk 70000-26	tk 70001-26	tk 70002-26
einfaches Gewinde simple thread	plan plane	hohl magnifying	rhodium Rhodium front surface

22 mm Fig. 4	tk 70003-22	tk 70004-22	-
24 mm Fig. 5	tk 70003-24	tk 70004-24	-
26 mm Fig. 6	tk 70003-26	tk 70004-26	-
cone-socket cone-socket	plan plane	hohl magnifying	



ø 22 mm / Fig. 4	tk 70008-22
ø 24 mm / Fig. 5	tk 70008-24

Packung à 12 Stück
Box of 12 pcs.

MEGA Spiegel, einfaches Gewinde
MEGA-mirror, simple thread

ø 22 mm / Fig. 4	tk 70009-22
------------------	--------------------

Packung à 6 Stück
Box of 6 pcs.

MEGAduo Spiegel haben ein doppelseitiges Spiegelglas, einfaches Gewinde
MEGAduo mirrors have a double sided mirror glass, simple thread

Mundspiegel und -griffe
Mouth mirrors and handles

Miroirs à bouche et manches
Espejos de boca y mangos
 Spechi per bocca e manici



hohl, rostfrei <i>hollow, stainless</i>	tk 70005-13	tk 70006-13
	einfaches Gewinde <i>simple thread</i>	cone-socket <i>cone-socket</i>



massiv, rostfrei <i>solid, stainless</i>	tk 70010-13	tk 70011-13
	einfaches Gewinde <i>simple thread</i>	cone-socket <i>cone-socket</i>



TEKNOFORM, hohl, rostfrei <i>TEKNOFORM, hollow, stainless</i>	tk 70020-14	-
	einfaches Gewinde <i>simple thread</i>	

Zahnpinzetten
Cotton and Dressing tweezers (Pliers)

Précelles (Brucelles) pour coton
Pinzas para algodón y curaciones
Pinzette da medicazione

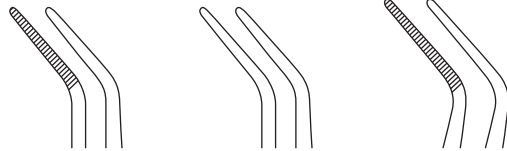

MERIAM

	Fig. 1	Fig. 2	Fig. 3
160 mm - 6¼"	tk 70050-01	tk 70050-02	tk 70050-03

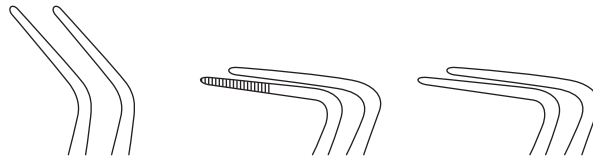

MERIAM

	Fig. 4	Fig. 5	Fig. 6
160 mm - 6¼"	tk 70050-04	tk 70050-05	tk 70050-06

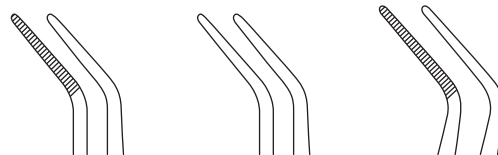

MERIAM

	Fig. 1	Fig. 2	Fig. 3
160 mm - 6¼"	tk 70052-01	tk 70052-02	tk 70052-03

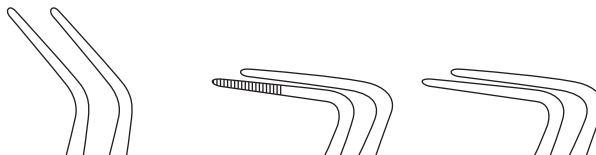

MERIAM

	Fig. 4	Fig. 5	Fig. 6
160 mm - 6¼"	tk 70052-04	tk 70052-05	tk 70052-06

Zahnpinzetten
Cotton and Dressing tweezers (Pliers)

Précelles (Brucelles) pour coton
Pinzas para algodón y curaciones
Pinzette da medicazione

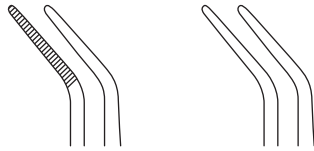

FLAGG

	Fig. 1	Fig. 2
160 mm - 6¼"	tk 70054-01	tk 70054-02

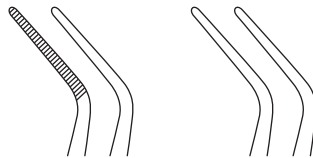

FLAGG

	Fig. 3	Fig. 4
160 mm - 6¼"	tk 70054-03	tk 70054-04



PERRY

130 mm - 5"
tk 70075-12



Zahnpinzetten
Cotton and Dressing tweezers (Pliers)

Précelles (Brucelles) pour coton
Pinzas para algodón y curaciones
Pinzette da medicazione



LONDON COLLEGE

	Fig. 3	Fig. 4	Fig. 5	Fig. 6	Fig. 8
150 mm - 6"	tk 70060-03	tk 70060-04	tk 70060-05	tk 70060-06	tk 70060-08



LONDON COLLEGE

	Fig. 5	Fig. 8
150 mm - 6"	tk 70064-05	tk 70064-08



COLLEGE MODIF.

160 mm - 6¼"
tk 70063-16

Zahnsonden
Probes and explorers

Sondes et explorateurs
Sondas y exploradores
Sonde ed esploratori



hohl
hollow

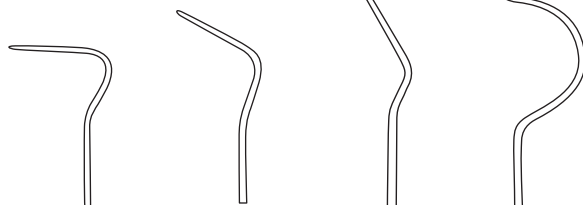

	Fig. 8	Fig. 9	Fig. 17	Fig. 23
Tekno	tk71101-08	tk71100-09	tk71101-17	tk71101-23

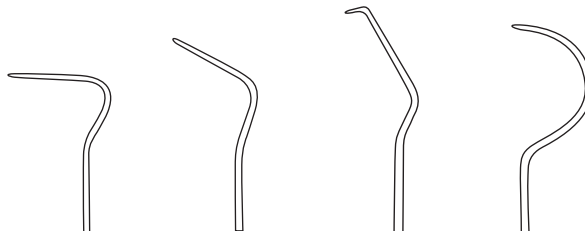

	Fig. 8	Fig. 9	Fig. 17	Fig. 23
Standard	tk71100-08	tk71100-09	tk71100-17	tk71100-23



Zahnsonden
Probes and explorers

Sondes et explorateurs
Sondas y exploradores
Sonde ed esploratori



hohl
hollow

	165 mm - 6 3/4"
Tekno	tk 71116-05



hohl
hollow

	165 mm - 6 1/2"
Tekno	tk 71116-09



hohl
hollow

	161 mm - 6 1/2"
Tekno	tk 71116-01



	165 mm - 6 3/4"
Standard	tk 71115-05



	165 mm - 6 1/2"
Standard	tk 71115-09



	161 mm - 6 1/2"
Standard	-



Paradontologie, nicht chirurgisch
Paradontology, not surgical

Paradontologie, non chirurgicale
Paradontología, no quirúrgica
 Strumenti per paradontologia



**Paradontometer
Peridontometers**

*Paradontomètres
Peridontometros
Peridontometri*



hohl
hollow



	Fig. 20
165 mm - 6½"	tk 71306-20

graduirt, 2-4-6-8-10-12 mm
graduated, 2-4-6-8-10-12 mm



	Fig. 25
160 mm - 6¼"	tk 71306-25

graduirt, 3-6-8-11 mm
graduated, 3-6-8-11 mm



	Fig. 30
165 mm - 6½"	tk 71306-30

graduirt, 3,5-5,5-8,5-11,5 mm
graduated, 3,5-5,5-8,5-11,5 mm



	Fig. 35
160 mm - 6¼"	tk 71306-35

graduirt, 3-6-9-12 mm
graduated, 3-6-9-12 mm



	Fig. 40
160 mm - 6¼"	tk 71306-40

graduirt, 1-2-3-4-5-6-7-8-9-10-11-12-13-14-15 mm
graduated, 1-2-3-4-5-6-7-8-9-10-11-12-13-14-15 mm

Paradontometer | *Paradontomètres*
Peridontometers | Peridontometros
 Peridontometri



hohl
hollow



	Fig. 10
170 mm - 6¾"	tk 71306-10

graduiert, 1-2-3-4-5-6-7-8-9-10-11-12-13-14-15 mm
graduated, 1-2-3-4-5-6-7-8-9-10-11-12-13-14-15 mm



Instrumente zur Parodontologie
Periodontia instruments

Instruments pour la parodontologie
Instrumentos para parodontología
Strumenti per parodontologia



hohl
hollow



COLUMBIA

173 mm - 6¾"	Fig. 2R-2L	Fig. 4R-4L	Fig. 13-14
	tk 71278-02	tk 71278-04	tk 71278-13

Für den Frontzahnbereich
For front teeth area

Für den posterioren Bereich
For posterior area

Ideal zum Glätten der Wurzeloberfläche
Perfect for smoothing of the rootz surfaces

TEKNO Gracey Küretten
TEKNO Gracey Curettes

TEKNO Gracey Curettes
TEKNO Gracey Curetas
TEKNO Gracey Curette

TEKNO Gracey Küretten sind in folgenden Ausführungen erhältlich:
TEKNO Gracey Curettes are available in the following patterns:
TEKNO Gracey Curettes sont disponibles dans les modèles suivants:
TEKNO Gracey Curetas son disponibles en los modelos siguientes
Le curette TEKNO Gracey sono fornibili nelle seguente esecuzioni:



GRACEY STANDARD

tk 71280-

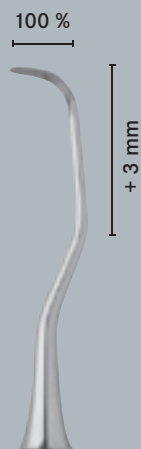

GRACEY LARGE

tk 71281-



GRACEY SMALL

tk 71282-

Instrumente zur Parodontologie
Periodontia instruments

Instruments pour la parodontologie
Instrumentos para parodontología
Strumenti per parodontologia



hohl
hollow



3-1	1-3
3-1	1-3



5-1	1-5
5-1	1-5



5-1	1-5
5-1	1-5

GRACEY STANDARD

174 mm - 6¾"	Fig. 1-2	Fig. 3-4	Fig. 5-6
	tk 71280-01	tk 71280-03	tk 71280-05

Für alle Flächen der Front- und Eckzähne
For all surfaces of the front teeth and canines

Für alle Flächen der Frontzähne und Prämolaren
For all surfaces of the front teeth and premolars

Für alle Flächen der Frontzähne und Prämolaren
For all surfaces of the front teeth and premolars



8-4	4-8
8-4	4-8

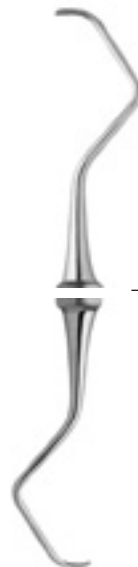

8-4	4-8
8-4	4-8



8-4	4-8
8-4	4-8

GRACEY STANDARD

174 mm - 6¾"	Fig. 7-8	Fig. 9-10	Fig. 11-12
	tk 71280-07	tk 71280-09	tk 71280-11

Für alle fazialen und oralen Flächen der Prämolaren und Molaren
For all facial and oral surfaces of the premolars and molars

Für alle fazialen und oralen Flächen der Prämolaren und Molaren
For all facial and oral surfaces of the premolars and molars

Für alle mesialen Flächen der Prämolaren und Molaren
For all mesial surfaces of the premolars and molars

Instrumente zur Parodontologie
Periodontia instruments

Instruments pour la parodontologie
Instrumentos para parodontología
Strumenti per parodontologia

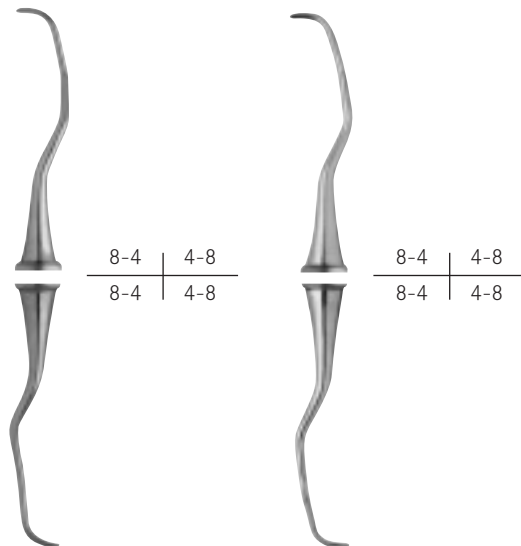
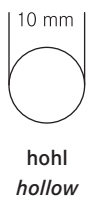

GRACEY STANDARD

174 mm - 6 3/4"	Fig. 11-14	Fig. 12-13
	tk 71280-14	tk 71280-12

Für alle mesialen und distalen Flächen der Prämolaren und Molaren
For all mesial and distal surfaces of the premolars and molars

Für alle mesialen und distalen Flächen der Prämolaren und Molaren
For all mesial and distal surfaces of the premolars and molars

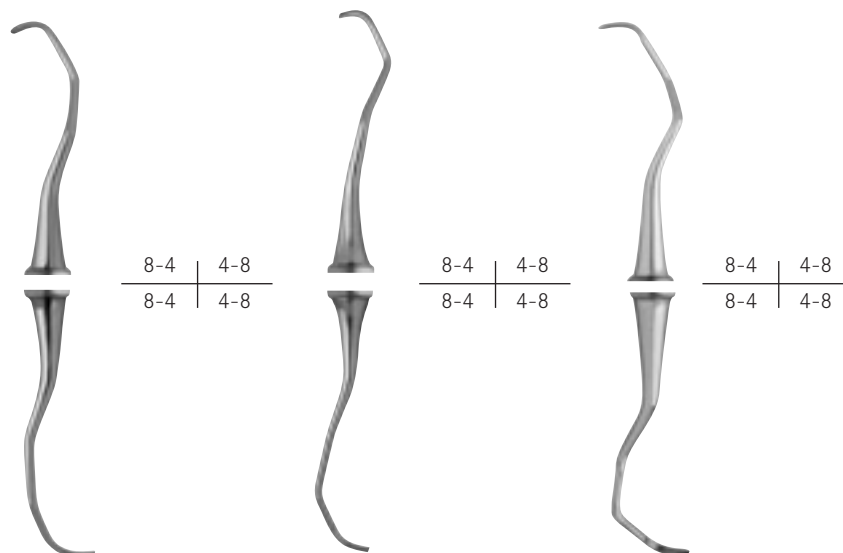

GRACEY STANDARD

174 mm - 6 3/4"	Fig. 13-14	Fig. 15-16	Fig. 17-18
	tk 71280-13	tk 71280-15	tk 71280-17

Für alle distalen Flächen der Prämolaren und Molaren
For all distal surfaces of the premolars and molars

Für alle mesialen Flächen der Prämolaren und Molaren
For all mesial surfaces of the premolars and molars

Für alle distalen Flächen der Prämolaren und Molaren
For all distal surfaces of the premolars and molars

Instrumente zur Parodontologie
Periodontia instruments

Instrumentos para la parodontología
Strumenti per parodontologia



hohl
hollow



3-1	1-3
3-1	1-3



5-1	1-5
5-1	1-5



5-1	1-5
5-1	1-5

GRACEY LARGE

174 mm - 6¾"	Fig. 1-2	Fig. 3-4	Fig. 5-6
	tk 71281-01	tk 71281-03	tk 71281-05

Für alle Flächen der Front- und Eckzähne
For all surfaces of the front teeth canines

Für alle Flächen der Frontzähne und Prämolaren
For all surfaces of the front teeth and premolars

Für alle Flächen der Frontzähne und Prämolaren
For all surfaces of the front teeth and premolars



8-4	4-8
8-4	4-8



8-4	4-8
8-4	4-8

GRACEY LARGE

174 mm - 6¾"	Fig. 7-8	Fig. 11-12
	tk 71281-07	tk 71281-11

Für alle facialen und oralen Flächen der Prämolaren und Molaren
For all facial and oral surfaces of the premolars and molars

Für alle mesialen Flächen der Prämolaren und Molaren
For all mesial surfaces of the premolars and molars

Instrumente zur Parodontologie
Periodontia instruments

Instruments pour la parodontologie
Instrumentos para parodontología
Strumenti per parodontologia

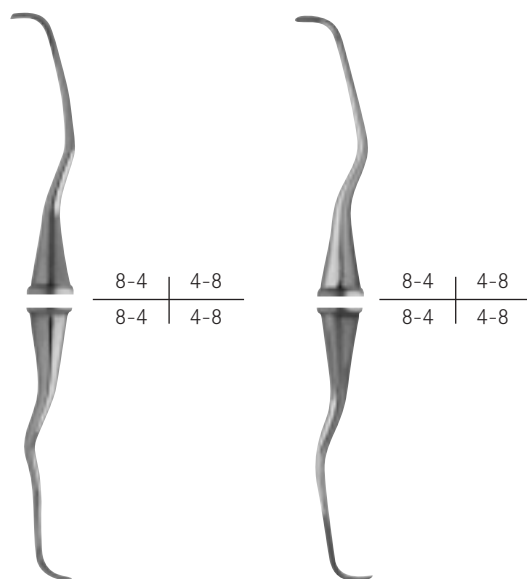
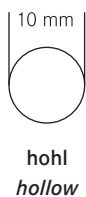

GRACEY LARGE

174 mm - 6 3/4"	Fig. 11-14	Fig. 12-13
	tk 71281-14	tk 71281-12

Für alle mesialen und distalen Flächen der Prämolaren und Molaren
For all mesial and distal surfaces of the premolars and molars

Für alle mesialen und distalen Flächen der Prämolaren und Molaren
For all mesial and distal surfaces of the premolars and molars

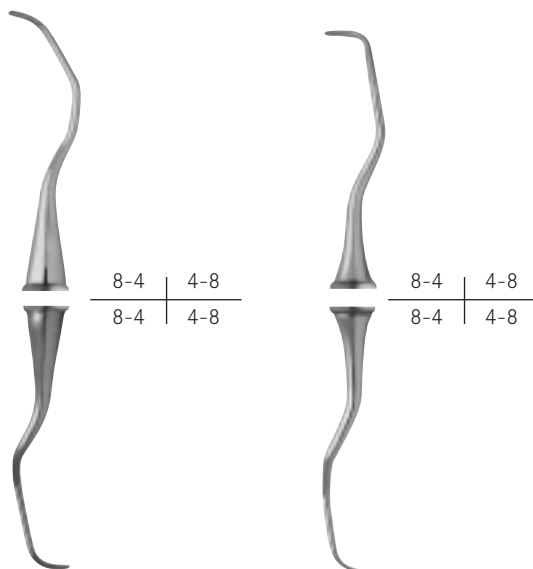

GRACEY LARGE

174 mm - 6 3/4"	Fig. 13-14	Fig. 15-16
	tk 71281-13	tk 71281-15

Für alle distalen Flächen der Prämolaren und Molaren
For all distal surfaces of the premolars and molars

Für alle mesialen Flächen der Prämolaren und Molaren
For all mesial surfaces of the premolars and molars

Instrumente zur Parodontologie
Periodontia instruments

Instruments pour la parodontologie
Instrumentos para parodontología
Strumenti per parodontologia



hohl
hollow



3-1	1-3
3-1	1-3



5-1	1-5
5-1	1-5



5-1	1-5
5-1	1-5

GRACEY SMALL

174 mm - 6¾"	Fig. 1-2	Fig. 3-4	Fig. 5-6
	tk 71282-01	tk 71282-03	tk 71282-05

Für alle Flächen der Front- und Eckzähne
For all surfaces of the front teeth and canines

Für alle Flächen der Frontzähne und Prämolaren
For all surfaces of the front teeth and premolars

Für alle Flächen der Frontzähne und Prämolaren
For all surfaces of the front teeth and premolars



8-4	4-8
8-4	4-8



8-4	4-8
8-4	4-8

GRACEY SMALL

174 mm - 6¾"	Fig. 7-8	Fig. 11-12
	tk 71282-07	tk 71282-11

Für alle facialen und oralen Flächen der Prämolaren und Molaren
For all facial and oral surfaces of the premolars and molars

Für alle mesialen Flächen der Prämolaren und Molaren
For all mesial surfaces of the premolars and molars

Instrumente zur Parodontologie
Periodontia instruments

Instruments pour la parodontologie
Instrumentos para parodontología
Strumenti per parodontologia

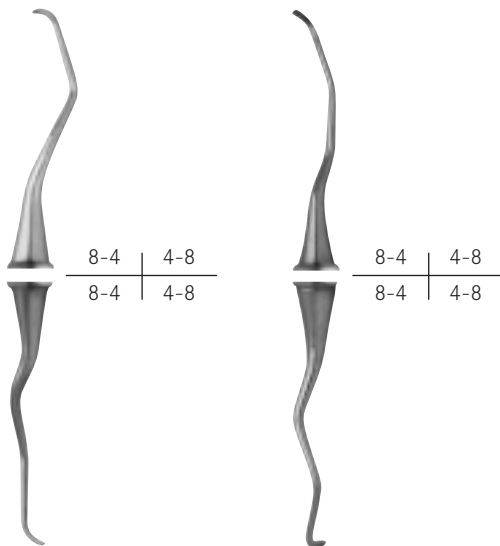
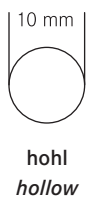

GRACEY SMALL

174 mm - 6 3/4"	Fig. 11-14	Fig. 12-13
	tk 71282-14	tk 71282-12

Für alle mesialen und distalen Flächen der Prämolaren und Molaren
For all mesial and distal surfaces of the premolars and molars

Für alle mesialen und distalen Flächen der Prämolaren und Molaren
For all mesial and distal surfaces of the premolars and molars

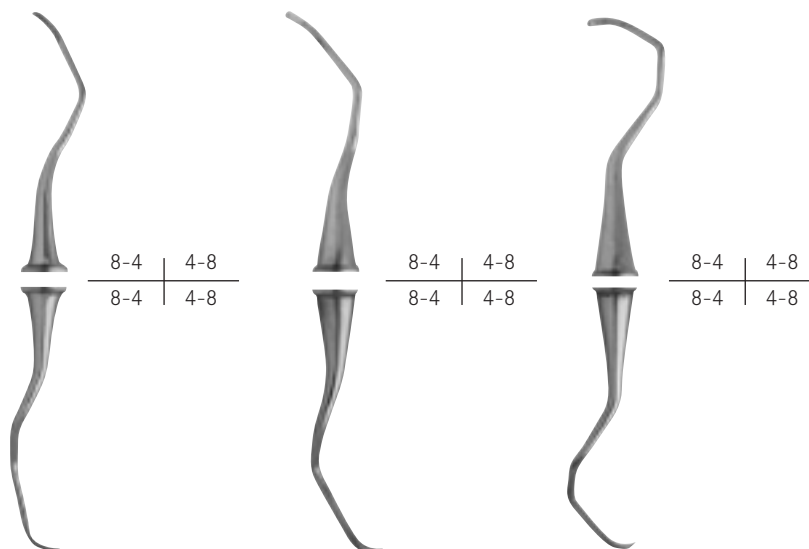

GRACEY SMALL

174 mm - 6 3/4"	Fig. 13-14	Fig. 15-16	Fig. 17-18
	tk 71282-13	tk 71282-15	tk 71282-17

Für alle distalen Flächen der Prämolaren und Molaren
For all distal surfaces of the premolars and molars

Für alle mesialen Flächen der Prämolaren und Molaren
For all mesial surfaces of the premolars and molars

Für alle distalen Flächen der Prämolaren und Molaren
For all distal surfaces of the premolars and molars

Instrumente zur Parodontologie
Periodontia instruments

Instruments pour la parodontologie
Instrumentos para parodontología
Strumenti per parodontologia



hohl
hollow

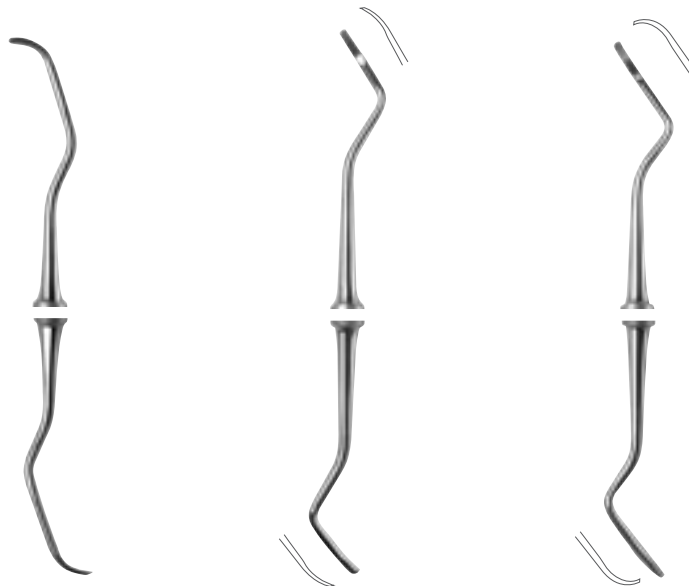

GOLDMAN-FOX

	Fig. 2	Fig. 3	Fig. 4
174 mm - 6¾"	tk 71283-02	tk 71283-03	tk 71283-04

Für Frontzähne und Prämolaren
Contour design for removal of calculus on anterior teeth and premolars

Speziell für die mesialen Molarenflächen geeignet
Especially designed for the proximal surface of the posterior teeth

Leichtes Arbeiten im Molarenbereich durch den zusätzlich gebogenen Ansatz
Additional bend in the shank for easier calculus removal

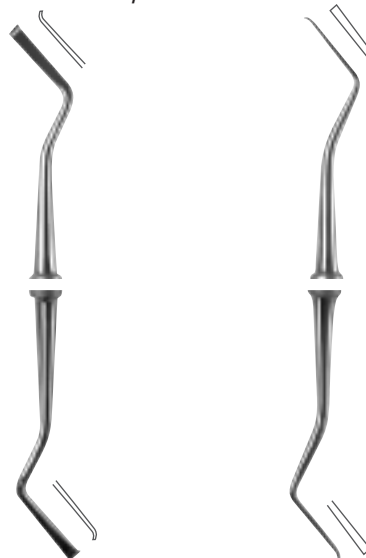

GOLDMAN-FOX

	Fig. 5	Fig. 6
174 mm - 6¾"	tk 71283-05	tk 71283-06

Hauenform zur Entfernung starker Zahnsteinablagerungen und optimaler Glättung der Wurzeloberfläche. Für bukkale und linguale Flächen
For removing heavy calculus deposits and for optimal smoothing of the root surfaces. For buccal and lingual surfaces

Hauenform für mesiale und distale Flächen an Prämolaren und Molaren
For mesial / distal surfaces of the posterior teeth or facial / lingual

Instrumente zur Parodontologie
Periodontia instruments

Instruments pour la parodontologie
Instrumentos para parodontología
 Strumenti per parodontologia

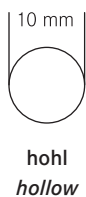

BARNHART

	Fig. 1-2	Fig. 5-6
174 mm - 6¾"	tk 71284-01	tk 71284-02

Universalküretten
 für den Seitenbereich
*Curette universal
 for side tooth area*

Universalküretten
 für den Frontzahnbereich
*Curette universal
 for front teeth area*



INDIANA UNIVERSITY

	Fig. 13-14	Fig. 17-18
174 mm - 6¾"	tk 71284-03	tk 71284-04

Für den
 Frontzahnbereich
For front teeth area

Ideal zum Entfernen von Gewebe
 an der Wurzeloberfläche bei
 schwer erreichbaren Stellen
 im molaren Bereich
*Designed for removing tissue
 on difficult to reach areas
 on the root surface
 in molar areas*

Instrumente zur Parodontologie
Periodontia instruments

Instruments pour la parodontologie
Instrumentos para parodontología
Strumenti per parodontologia



hohl
hollow



MC CALL

	Fig. 17S-18S	Fig. 19-20
174 mm - 6¾"	tk 71284-06	tk 71284-07

Die geradflankigen Arbeitsteile haben abgerundete Arbeitsenden
Arbeitsbereich: Molaren
The straight-sided universal blade has a rounded toe. Working area: molars

Die geradflankigen Arbeitsteile haben abgerundete Arbeitsenden
Arbeitsbereich: Molaren
The straight-sided universal blade has a rounded toe. Working area: molars



SPECIAL

	Fig. 23A
174 mm - 6¾"	tk 71284-08

Posterior
Posterior

YOUNGER-GOOD

	Fig. 7-8
174 mm - 6¾"	tk 71284-05

Die elliptisch geformten Arbeitsteile haben abgerundete Arbeitsenden.
Arbeitsbereich: Molaren
The elliptical blade shape has a rounded toe. Working area: molars

Instrumente zur Parodontologie
Periodontia instruments

Instruments pour la parodontologie
Instrumentos para parodontología
 Strumenti per parodontologia

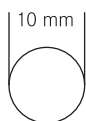

hohl
 hollow



LANGER

	Fig. 1-2	Fig. 3-4
174 mm - 6¾"	tk 71285-01	tk 71285-03

Für alle Flächen im molaren und prämolaren Unterkieferbereich
For all surfaces of mandibular posterior

Für alle Flächen im molaren und prämolaren Oberkieferbereich
For all surfaces of maxillary posterior



LANGER

	Fig. 5-6	Fig. 17-18
174 mm - 6¾"	tk 71285-05	tk 71285-17

Für alle Flächen im Frontzahnbereich, Ober- und Unterkiefer
For all surfaces of mandibular and maxillary anterior

Für alle Flächen im molaren und prämolaren Ober- und Unterkiefer
For all surfaces of mandibular and maxillary posterior

Zahnreiniger
Scalers

Instruments à détartre
Limpiadores de sarro
Strumenti levatartaro



hohl
hollow



MC CALL

	Fig. 11-12	Fig. 11A-12A
174 mm - 6¾"	tk 71208-11	tk 71208-12

Die spitz auslaufenden
Arbeitsenden sind
besonders gut für
Interdentalräume geeignet
*These scalers have tapering
pointed working ends and
are very applicate for
interdental cavities*

Die spitz auslaufenden
Arbeitsenden sind
besonders gut für
Interdentalräume geeignet
*These scalers have tapering
pointed working ends and
are very applicate for
interdental cavities*



MC CALL

	Fig. 13-14	Fig. 13S-14S
174 mm - 6¾"	tk 71208-13	tk 71208-14

Die spitz auslaufenden
Arbeitsenden sind
besonders gut für
Interdentalräume geeignet
*These scalers have tapering
pointed working ends and
are very applicate for
interdental cavities*

Die spitz auslaufenden
Arbeitsenden sind
besonders gut für
Interdentalräume geeignet
*These scalers have tapering
pointed working ends and
are very applicate for
interdental cavities*

Zahnreiniger
Scalers

Instruments à détartrer
Limpiadores de sarro
Strumenti levatartaro



hohl
hollow

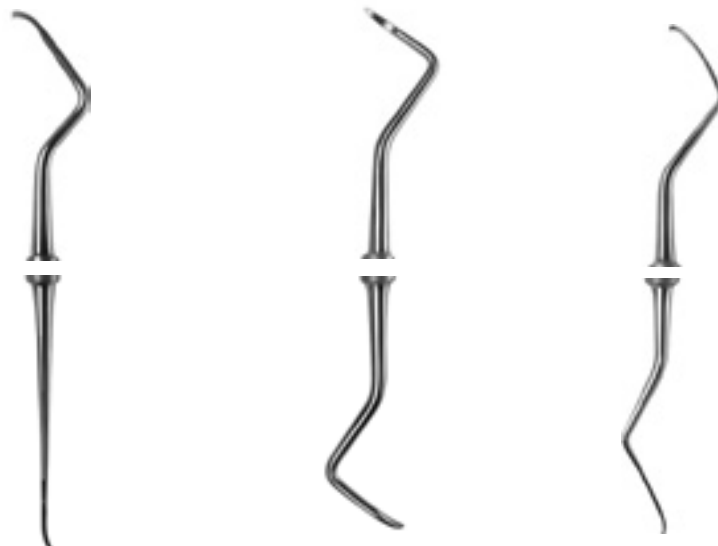

CATTONI

	Fig. 104-105	Fig. 107-108	Fig. 156-577
174 mm - 6¾"	tk 71211-04	tk 71211-07	tk 71211-56

Haue | Meißel
Hoe | Chisel

Interdentalscaler für
Front- und Seitenzähne
*Interdental scaler for
front and side teeth*

Für das Entfernen von
interdentalem Zahnstein
im Frontzahnbereich
des Unterkiefers
*Suitable to dislodge bridges
of calculus on anterior
mandibular teeth*



DARBY-PERRY

	Fig. 5K-6K
174 mm - 6¾"	tk 71212-05

Meißel
Chisel

Zahnreiniger - Sichelreiniger
Scalers - Sickle scalers

Instruments à détartrer - Détartreurs faucilles
Limpiadores de sarro - Limpiadores forma de hoz
Strumenti levatartaro



hohl
hollow



HYGIENIST

	Fig. H6-H7
174 mm - 6¾"	tk 71213-01



HYGIENIST-TOWNER

	Fig. H5-U15
174 mm - 6¾"	tk 71213-02



TOWNER-JAQUETTE

	Fig. U15-33	Fig. U15-30
174 mm - 6¾"	tk 71213-03	tk 71213-04



HYGIENIST-JAQUETTE

	Fig. H5-33
174 mm - 6¾"	tk 71213-05

Instrument mit feinen Arbeitsenden. Geeignet zum Reinigen von mesialen und distalen Flächen im Frontzahn- und Prämolarenbereich
Instrument with super-thin working parts. Effective for interproximal areas. Shank angulation provides accessibility to all anterior and premolar surfaces.

Zahnreiniger - Sichelreiniger
Scalers - Sickle scalers

Instruments à détartrer - Détartreurs faucilles
Limpiadores de sarro - Limpiadores forma de hoz
Strumenti levatartaro

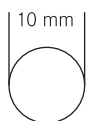

hohl
hollow



JAQUETTE

	Fig. 30-33	Fig. 31-32
174 mm - 6¾"	tk 71213-06	tk 71213-07

Frontzahnbereich.
Front tooth area.

Molarenbereich.
Molar area.



JAQUETTE

	Fig. 34-35	Fig. 2-3	Fig. 2S-3S
174 mm - 6¾"	tk 71213-08	tk 71213-09	tk 71213-10

Molarenbereich
Molar area

Posterior
Posterior

Posterior
Posterior

Zum Entfernen von supragingivalem Zahnstein und Konkrementen sowie zur Glättung der Wurzeloberfläche. Die sichelförmigen Scaler haben je Arbeitsende zwei schneidende Kanten, die als Spitze zulaufen.
For removing supragingival tartar and concretions and for smoothing the root surface. On each end the sickle-shaped scalers have a two cutting edges which are tapered at the end to form a point.

Zahnreiniger - Sichelreiniger
Scalers - Sickle scalers

Instruments à détartrer - Détartreurs faucilles
Limpiadores de sarro - Limpiadores forma de hoz
Strumenti levatartaro



hohl
hollow



	Fig. 204	Fig. 204S	Fig. 204SD
174 mm - 6¾"	tk 71212-01	tk 71212-02	tk 71212-03

Zur supragingivalen
Reinigung im
Molarenbereich
*For posterior
supragingival
interproximal scaling*

Für schmale
Interdentalräume
an Prämolaren- und
Frontzähnen
*For better access
to distal surfaces*



DEPPELER

	Fig. M-23
174 mm - 6¾"	tk 71212-23

Posterior
für Prämolaren, Molaren
und Frontzähne
*Posterior
For premolars, molars
and incisors*

CRANE-KAPLAN

	Fig. CK6
170 mm - 6¾"	tk 71212-06

Posterior
Posterior

	Fig. 23
174 mm - 6¾"	tk 71212-04

Posterior
Posterior

Zahnreiniger - Sichelreiniger
Scalers - Sickle scalers

Instruments à détartrer - Détartreurs faucilles
Limpiadores de sarro - Limpiadores forma de hoz
Strumenti levatartaro

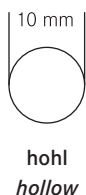

MAC FARLANE

	Fig. 2-3	Fig. 4-5
174 mm - 6¾"	tk 71212-07	tk 71212-08



GOLDMAN-FOX

	Fig. 1	Fig. 21
174 mm - 6¾"	tk 71212-09	tk 71212-10

Universalscaler für Interdentalräume bzw. oralen und fazialen Flächen
Universal scaler for oral and facial surfaces or for interdental cavities

Eine Seite mit gebogenem Sichelscaler zur Entfernung nekrotischen Gewebes und kleiner Rückstände bei einer Kürettage, die andere Seite mit kleiner Reinigungskürette
One side with a small cleaning curette, the other side with curved sickle scaler for removing necrotic tissue and slight residues on curettage

Schleifsteine
Grinding stones

Pierres d'affûtage
Mollejones
Mole



ARKANSAS

80 mm - Ø 6 mm	tk 71289-00
----------------	--------------------

rund, auch für Perioluxe
round, also used for Perioluxe



ARKANSAS

	Universal
70 x 32 mm / 10 x 3 mm	tk 71289-02



ARKANSAS

	Fig. 4
100 x 25 x 7 mm	tk 71289-04

flach
plane



ARKANSAS

	Fig. 299
85 mm / Ø 8 mm	tk 71289-06

konisch
cone-shaped



INDIA

	Fig. 6
110 x 40 mm / 9 x 3 mm	tk 71289-08

keilförmig
wedge-shaped



75 mm / Ø 7 mm	tk 71289-10
----------------	--------------------

Kunststoff Teststab
Plastic test stick



Parodontal Chirurgie
Periodontal surgery

Paradontologie chirurgicale
Paradontología quirúrgica
Chirurgia parodontale



Gingivektomiemesser
Gingivectomy knives

Bistouris pour la gingivectomie
Bisturis para la gingivectomia
Bisturi per gingivectomia



hohl
hollow

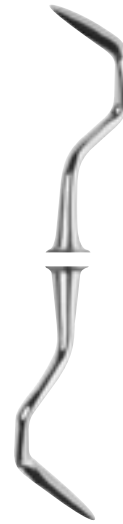
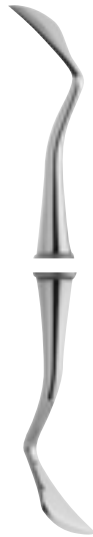

KIRKLAND

	Fig. 15K-16K
170 mm - 6¾"	tk 71290-01

Für die initiale Inzision bei der Gingivektomie oder gingivoplastische Behandlungen, besonders für den retromolaren Bereich geeignet
For initial incision in gingivectomy and gingivoplastic. Especially effective in retro-molar region

ORBAN

	Fig. 1-2
170 mm - 6¾"	tk 71290-02

Anwendung im molaren Bereich, auch zum Ausschneiden von interdentalem Zahnfleisch
Especially effective for posterior region, also useful for excising interproximal tissue

Zahntaschen-Markierpinzetten
Dental pocket marker tweezers

Pinces à marquer les poches périodontales
 Pinzas para marcar bolsas periodontales
 Pinzette per marcare le tasche



CRANE-KAPLAN

150 mm - 6"

tk 70080-15

rechts, graduert, 1-2-3-4-5-6-7-8-9 mm
 right, graduated, 1-2-3-4-5-6-7-8-9 mm



CRANE-KAPLAN

150 mm - 6"

tk 70081-15

links, graduert, 1-2-3-4-5-6-7-8-9 mm
 left, graduated, 1-2-3-4-5-6-7-8-9 mm

Parodontalfeilen
Periodontal rasps

Limes pour la parodontologie
Limas para parodontología
Lime per parodontologia



hohl
hollow

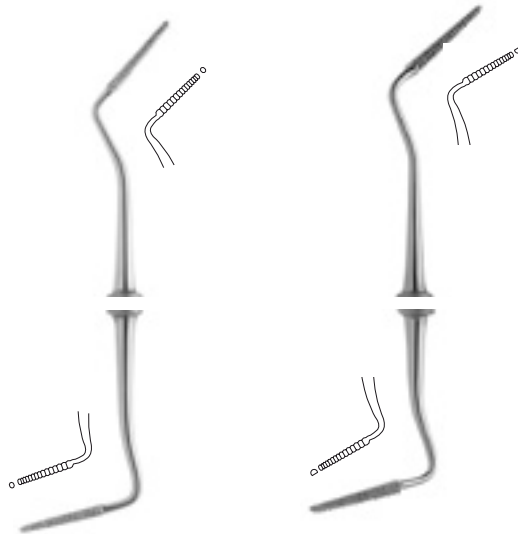

SUGERMAN

	Fig. 1S-2S	Fig. 3S-4S
170 mm - 6¾"	tk 71291-01	tk 71291-02

Mesial, distal
Zur Entfernung von
Granulationsgewebe
*Mesial, distal
for removal of
granulomatous tissue*

Buccal, lingual
Zur Entfernung von Granulationsgewebe
in horizontalen und vertikalen
Taschen
*Buccal, oral,
For removal of granulomatous tissue
in horizontal and vertical pockets*

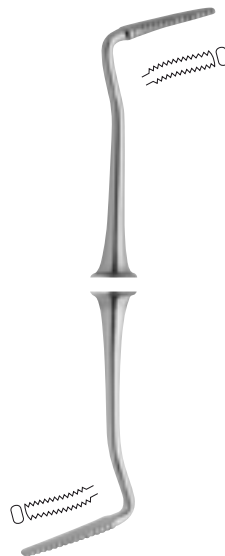

SCHLUGER

	Fig. 9-10
170 mm - 6¾"	tk 71291-03

gebogen
Zur Entfernung von
Granulationsgewebe
*curved
For removal of
granulomatous tissue*

Paradontalfeilen
Periodontal rasps

Limes pour la parodontologie
Limas para paradontología
Lime per parodontologia



hohl
hollow

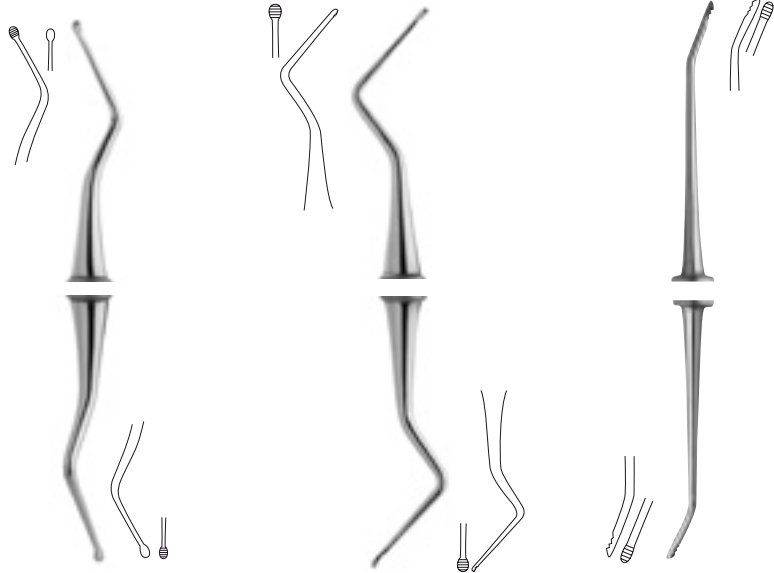

HIRSCHFELD

	Fig. 3-7	Fig. 5-11	Fig. 9-10
170 mm - 6¾"	tk 71291-04	tk 71291-05	tk 71291-06

Buccal, lingual
Zum Entfernen harten
Zahnsteins
Buccal, oral
Used to remove heavy

Mesial, distal
Zum Entfernen harten
Zahnsteins
Buccal, oral
Used to remove heavy

Anterior
Anterior
Antérieur

Chirurgische Küretten
Periodontal surgical curettes

Curettes chirurgicales
Curetas quirurgicas
Curette chirurgiche



hohl
hollow



PRICHARD

170 mm - 6¾"

tk 71212-12

Zur Entfernung von harten subgingivalen Ablagerungen und Granulationsgewebe
For the removal of hard sub-gingival deposits and granulation tissue

Der Meißel empfiehlt sich zum atraumatischen Abtragen von anliegendem Knochenmaterial und ist besonders geeignet an den hinteren distalen Molaren (ziehende Anwendung)

The chisel is used for removing bone adjacent to the tooth without causing trauma, and is especially useful on the distal of last molars (pull stroke)

Parodontal Meißel
Periodontal chisels

Ciseaux parodontaux
Lima periodontal
Scalpelli paradontali

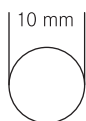

hohl
hollow

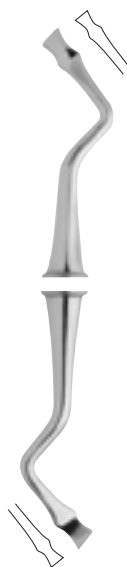

OCHSENBEIN

	Fig. 3	Fig. 4
170 mm - 6 3/4 "	tk 71292-30	tk 71292-40

Meißel zum Entfernen
und Konturieren von
Knochen
*Chisel for removing
and reshaping bone*

Meißel zum Entfernen
und Konturieren von
Knochen
*Chisel for removing
and reshaping bone*

Parodontal Meißel
Periodontal chisels

Ciseaux parodontaux
Lima periodontal
ScalPELLI paradontali



hohl
hollow

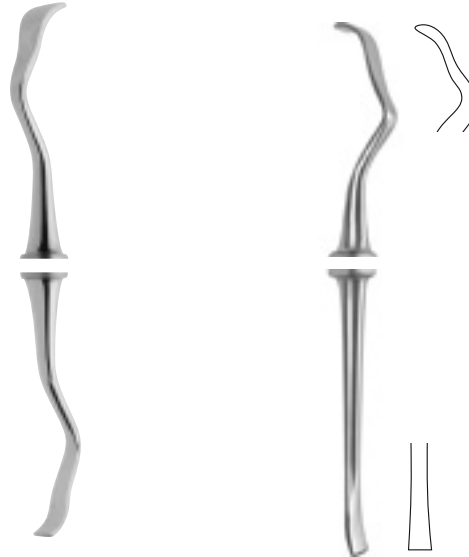

KIRKLAND

	Fig. 13K-13KL	Fig. 13K-TG
170 mm - 6¾"	tk 71292-60	tk 71292-70



RHODES

170 mm - 6¾"	tk 71292-50
--------------	--------------------

Der Meißel empfiehlt sich zum atraumatischen Abtragen von anliegendem Knochenmaterial und ist besonders geeignet an den hinteren distalen Molaren (ziehende Anwendung)

The chisel is used for removing bone adjacent to the tooth without causing trauma, and is especially useful on the distal of last molars (pull stroke)

Parodontal Meißel
Periodontal chisels

Ciseaux paradontaux
Lima periodontal
 Scalpelli paradontali



OCHSENBEIN

	Fig. 1	Fig. 2
170 mm - 6¾"	tk 71292-10	tk 71292 -20
	aufwärts gebogen Zum Entfernen und Konturieren von Knochen <i>curved upwards</i> <i>For removing and reshaping bone</i>	abwärts gebogen Zum Entfernen und Konturieren von Knochen <i>curved downwards</i> <i>For removing and reshaping bone</i>



Endodontie | Endodontie
Endodontic | *Endodoncia*
Endodonzia



Mundspiegelgriffe / Micro-Resektionsspiegel
 Mouth mirror handles / Micro resection mirrors

Manches à miroirs / Micro miroirs à résection
 Mangos para espejos / Micro-espejos de resección
 Micro specchietti e manici



45 mm, ø 3,0 mm
tk 70017-03

Rhodium Front beschichtet,
 einzeln verpackt, einfaches Gewinde
*Front side rhodium plated,
 single packed, simple thread*



46 mm, ø 5,0 mm
tk 70017-05

Rhodium Front beschichtet,
 einfaches Gewinde
*Front side rhodium plated,
 simple thread*



45 mm, 2,0 x 7,0 mm
tk 70017-07

Rhodium Front beschichtet,
 einfaches Gewinde
*Front side rhodium plated,
 simple thread*



hohl, rostfrei, einfaches Gewinde
hollow, stainless, simple thread **tk 70005-13**



massiv, rostfrei, einfaches Gewinde
solid, stainless, simple thread **tk 70010-13**



TEKNOFORM, hohl, rostfrei, einfaches Gewinde
TEKNOFORM, hollow, stainless, simple thread **tk 70020-14**

Zahnsonden, einendig
Probes and explorers, single ended

Sondes et explorateurs, simples
Sondas y exploradores, simples
 Sonde d'esplorazione, singole



hohl
hollow



	Fig. 23	Fig. 9
Tekno	tk 71101-23	tk 71101-09

Zum Auffinden von
 Wurzelkanälen

Zum Auffinden von
 Wurzelkanälen



	Fig. 23	Fig. 9
Standard	tk 71100-23	tk 71100-09

Zum Auffinden von
 Wurzelkanälen

Zum Auffinden von
 Wurzelkanälen



Endodontie-Pinzetten
Endodontic Tweezers

Pinces pour endodontie
Pinzas para endodoncia
Pinzette per endonzia

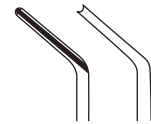
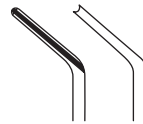
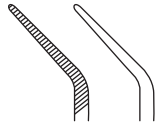

LONDON COLLEGE

	Fig. 5	Fig. 7	Fig. 8
150 mm - 6"	tk 70064-05	tk 70064-07	tk 70064-08

mit Sperre
with lock

mit Sperre
Für Stift und
Nervnadeln
with lock
*For introducing medicines,
to hold silver pins and
nerve broaches*

mit Sperre
Für Stift und
Nervnadeln
with lock
*For introducing medicines,
to hold silver pins and
nerve broaches*

Wurzelsplitterzangen
Root splinter forceps

Daviers pour fragments des racines
Forceps para fragmentos de raíces
Pinze per frammenti

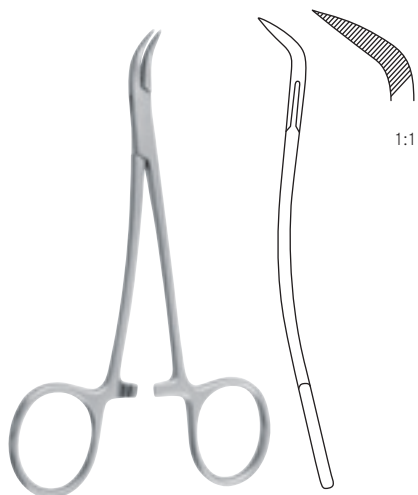

PEET

120 mm - 4¾" tk 71029-11



RALK

190 mm - 7½" tk 71025-15

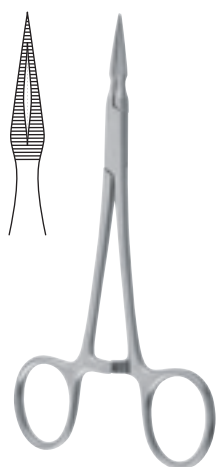

STIEGLITZ

140 mm - 5½" tk 71026-13

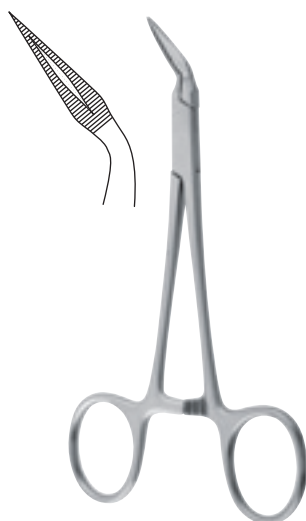

STIEGLITZ

135 mm - 5½" tk 71027-13

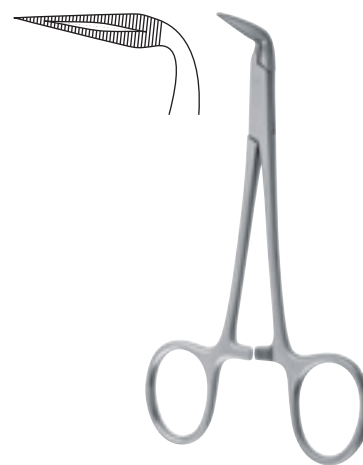

STIEGLITZ

125 mm - 5" tk 71028-13

Wurzelsplitterzangen
Root splinter forceps

Daviers pour fragments des racines
Forceps para fragmentos de raíces
Pinze per frammenti

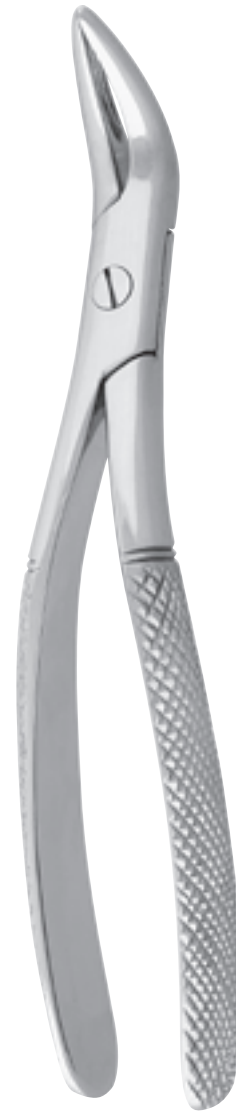
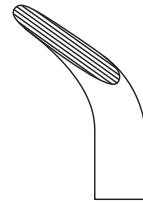
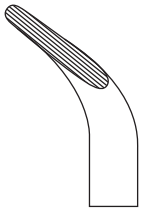

WITZEL

155 mm - 6 "

tk 71030-15

Für die unteren Wurzeln und Zähne
For lower roots and teeth

WITZEL

155 mm - 6 "

tk 71031-15

Für die oberen Wurzeln und Zähne
For upper roots and teeth

Zangen für Nervnadeln
Pliers for nerve needles

Pinces pour aiguilles de nerfs
Pinzas para agujas de nervios
Pinze per aghi di nervi

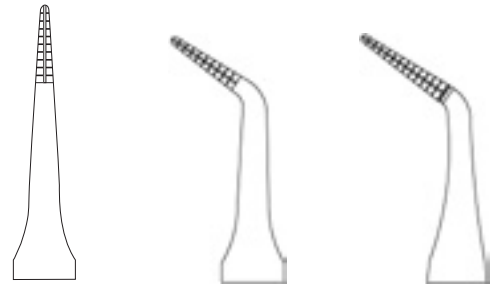

150 mm - 6"

tk 71032-01

tk 71032-02

tk 71032-03



Extraktion | Extraction
Extraction | *Extracción*
Estrazione



Periotome, einendig
Periotomes, single ended

Périotomes, simples
Periotomos, simples
Periotomi, singoli



hohl
hollow



	2.0 mm	2.0 mm	2.0 mm
170 mm - 6¾"	tk 71033-01	tk 71033-02	tk 71033-03
	gerade <i>straight</i>	über Fläche gebogen <i>curved over surface</i>	abgewinkelt <i>curved over surface</i>

Eignen sich bestens für die schonende Durchtrennung des Periodontiums. Die dabei nur minimale Schädigung des umgebenden Alveolarknochens führt zu einer schonenden Zahnextraktion

Optimally adapted for the careful detachment of the periodontium. The result is a gently extraction due to the only minimum trauma of the enclosed alveolar bone

Periotome, doppelendig
Periotomes, double ended

Périotomes, doubles
Periotomos, dobles
 Periotomi, doppi



hohl
hollow



	2.0 / 2.0 mm	2.0 / 2.0 mm	2.0 / 2.0 mm
170 mm - 6¾"	tk71034-01	tk71034-02	tk71034-03
	abgewinkelt über Fläche gebogen <i>angled</i> <i>curved over surface</i>	abgewinkelt gerade <i>angled</i> <i>straight</i>	über Fläche gebogen gerade <i>curved over surface</i> <i>straight</i>

Wurzelheber
Root elevators

Elévateurs à racines
Elevadores para raíces
Leve

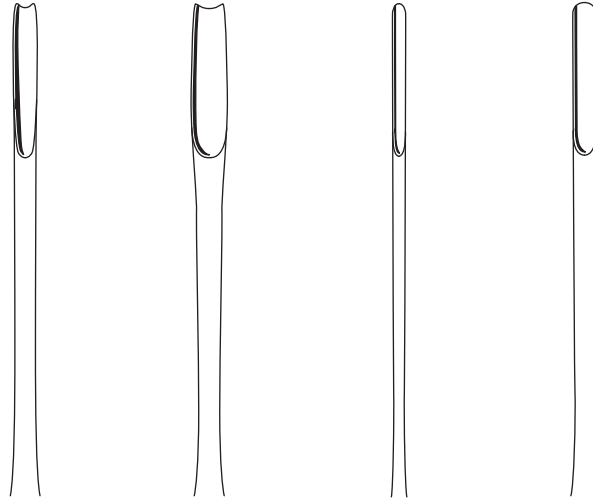

BEIN

	Fig. 1	Fig. 2	Fig. 9	Fig. 3
	3 mm	4 mm	2 mm	3 mm
140 mm - 5½"	tk 70200-01	tk 70200-02	tk 70200-09	tk 70200-03

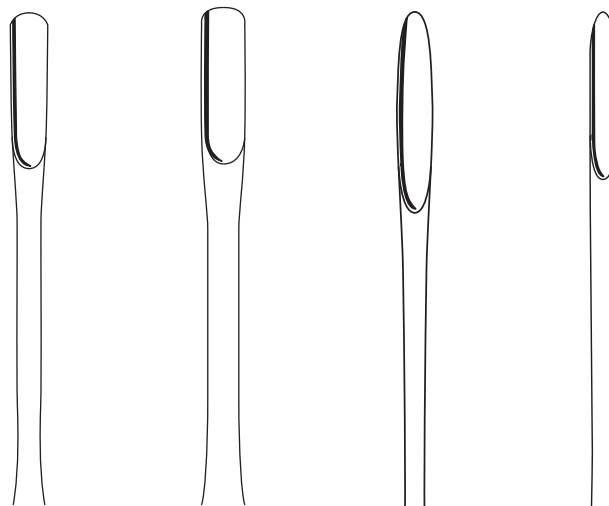

BEIN

	Fig. 4	Fig. 7	Fig. 6	Fig. 5
	4 mm	5 mm	4 mm	3 mm
140 mm - 5½"	tk 70200-04	tk 70200-07	tk 70200-06	tk 70200-05

Wurzelheber
Root elevators

Elévateurs à racines
Elevadores para raíces
Leve

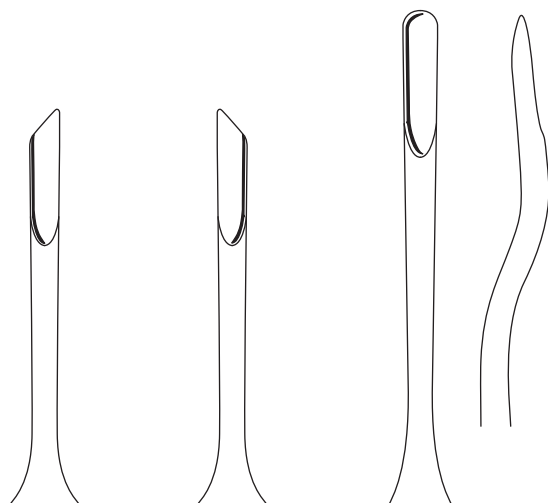

	3.5 mm	3.5 mm	4 mm
140 mm - 5½"	tk 70202-08	tk 70202-07	tk 70202-06

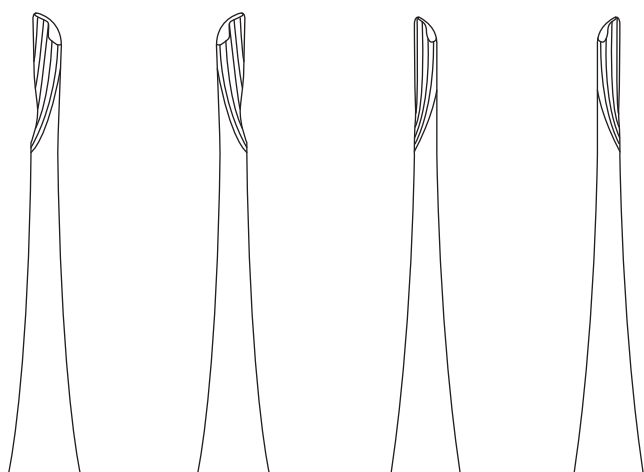

KOPP

	4.5 mm	4.5 mm	3.5 mm	3.5 mm
130 mm - 5¼"	tk 70203-01	tk 70203-02	tk 70203-03	tk 70203-04



Wurzelheber
Root elevators

Elévateurs à racines
Elevadores para raíces
Leve

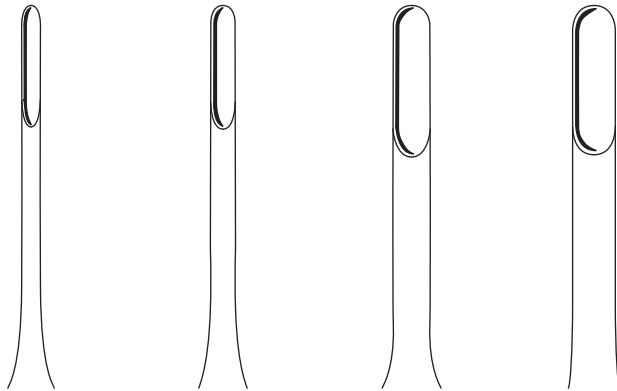

GÄRTNER

	2.5 mm	3.5 mm	4.5 mm	5.5 mm
125 mm - 5"	tk 70201-01	tk 70201-02	tk 70201-03	tk 70201-04

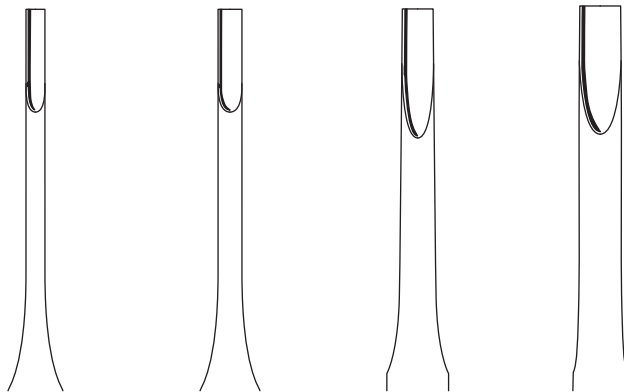

GÄRTNER

	2.5 mm	3.5 mm	4.5 mm	5.5 mm
125 mm - 5"	tk 70201-05	tk 70201-06	tk 70201-07	tk 70201-08

Wurzelheber
Root elevators

Elévateurs à racines
Elevadores para raíces
Leve

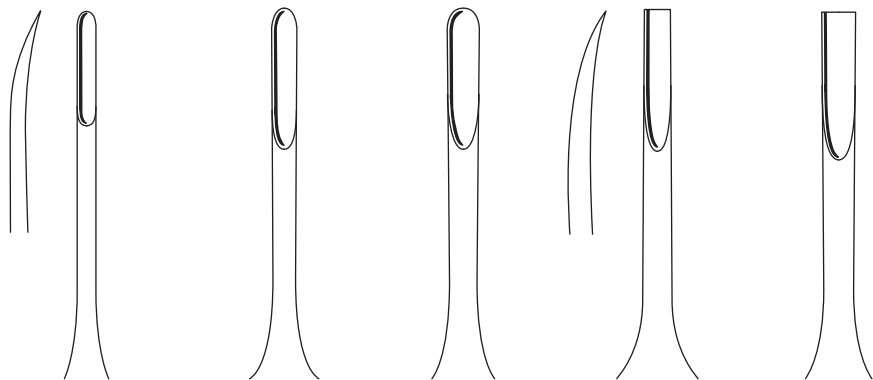

GÄRTNER

	2.5 mm	3.5 mm	4.5 mm	3.5 mm	4.5 mm
125 mm - 5"	tk 70201-14	tk 70201-15	tk 70201-16	tk 70201-17	tk 70201-18

Wurzelheber
Root elevators

Elévateurs à racines
Elevadores para raíces
Leve

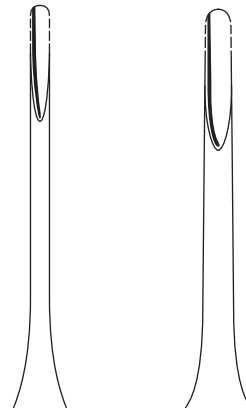

LINDO-LEVIN

	3.5 mm	4.5 mm
125 mm - 5"	tk 70201-21	tk 70201-22



Mini-Perioluxe *Mini-Periolux*

Mini-Périoluxe
Mini-Periolux
Mini-Periolux



Die Sofortimplantation nach einer schonend, atraumatischen Extraktion, rückt in der modernen Implantologie immer mehr in den Vordergrund. Somit besteht mehr und mehr die Notwendigkeit Hart- und Weichgewebestrukturen bereits bei der Extraktion so schonend wie möglich zu behandeln. Die TK-LUX Instrumente sind die logische Weiterentwicklung der Periotome und eignen sich hervorragend für die mesiale und distale Bearbeitung der Wurzelstrukturen. Dies verhindert weitgehend Frakturen bei den, für die Implantation wichtigen Knochenlamellen. TK-LUX Instrumente sind darüber hinaus die perfekte Ergänzung zu den bekannten Extraktionsinstrumenten und dienen zur schonenden Entfernung der nicht erhaltungsfähigen Zähne.

TK LUX Instrumente zeichnen sich vor allem aus durch:

- leichte und neu designte Griffe für ein ermüdungsfreies Arbeiten,
- ideale Griffgröße zur Vermeidung übermäßigen Kraftaufwands,
- atraumatisches Arbeiten, mit minimalem Risiko der Verletzung benachbarter Strukturen.

Das flach geformte Arbeitsende erweitert schonend die Alveole, Ligamente können durch eine leichte Drehbewegung einfach durchtrennt werden.

Immediate implantation, after a gentle and atraumatic extraction, is becoming more and more important in modern implantology. Thus the atraumatic treatment of hard and soft tissue structures is a necessity already during the extraction. TK-LUX instruments are the logic sequel of periotomes and are perfectly appropriate for the mesial and distal treatment of root structures. This widely avoids the damage of bone structures which are important for the following implantation. TK-LUX instruments are also the perfect addition to the well known extraction instruments, as they help to extract teeth in a very gentle way.

TK-LUX instruments mainly characterize by:

- *lightweight new designed handles for fatigue-proof working*
- *the ideal handle size to avoid excessive efforts*
- *atraumatic treatment with the minimal risk of causing lesions to neighboring structures.*

The flat working end is especially designed to save the alveole, ligaments can be easily cut by slight rotating movements.

Wurzelheber | Elévateurs à racines
Root elevators | Elevadores para raíces
Leve

LUXTK

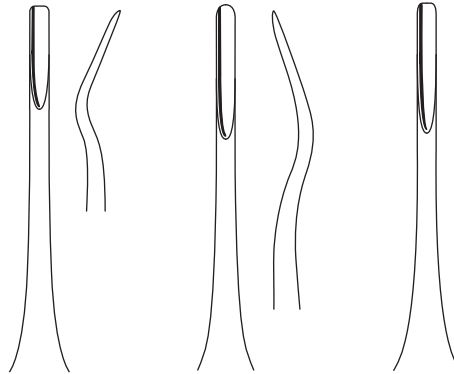

	Fig. 1	Fig. 2	Fig. 4
	2,5 mm	2,5 mm	2,5 mm
140 mm - 5½"	tk 70208-01	tk 70208-02	tk 70208-04
	mesial <i>mesial</i>	distal <i>distal</i>	gerade <i>straight</i>

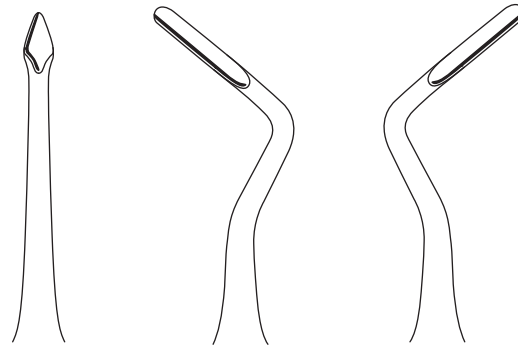

	Fig. 3	Fig. 8	Fig. 9
	4,0 mm	2,5 mm	2,5 mm
140 mm - 5½"	tk 70208-03	tk 70208-08	tk 70208-09
	lanzenförmig <i>lance</i>	links gebogen <i>left bended</i>	rechts gebogen <i>right bended</i>

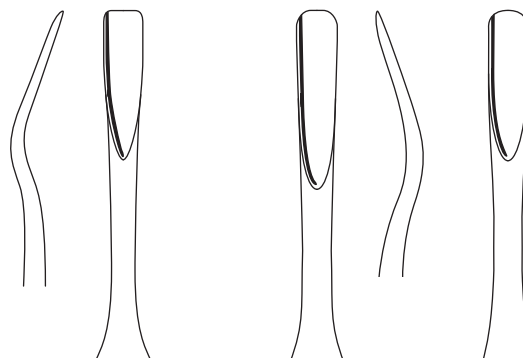
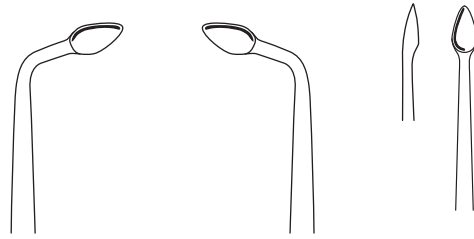

	Fig. 5	Fig. 6	Fig. 7
	5,0 mm	5,0 mm	5,0 mm
140 mm - 5½"	tk 70208-05	tk 70208-06	tk 70208-07
	mesial <i>mesial</i>	distal <i>distal</i>	gerade <i>straight</i>

Wurzelheber
Root elevators

Elévateurs à racines
Elevadores para raíces
Leve



BERNARD

	Fig. 6	Fig. 7	Fig. 1
150 mm - 5¾"	tk 70219-46	tk 70219-47	tk 70219-45

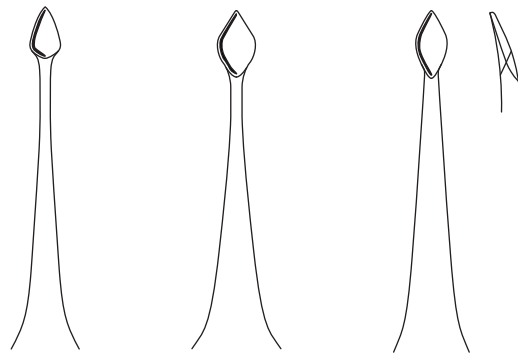

BERNARD

	Fig. 60	Fig. 66	Fig. 63
150 mm - 5¾"	tk 70219-48	tk 70219-49	tk 70219-50

Wurzelheber
Root elevators

Elévateurs à racines
Elevadores para raíces
Leve

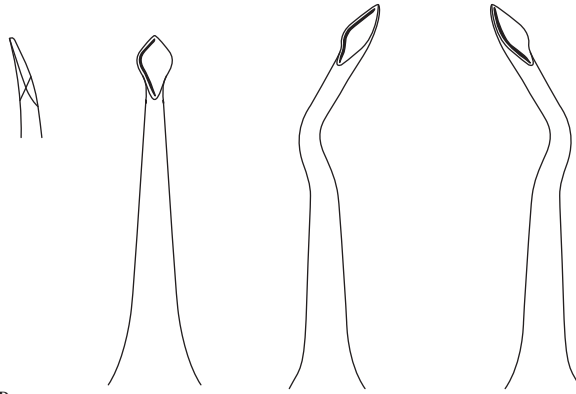

BERNARD

	Fig. 66B	Fig. 67R	Fig. 67L
150 mm - 5 3/4"	tk 70219-51	tk 70219-52	tk 70219-53

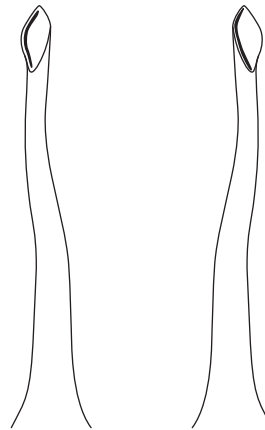

BERNARD

	Fig. 60B	Fig. 60U
150 mm - 5 3/4"	tk 70219-54	tk 70219-55

Wurzelheber
Root elevators

Elévateurs à racines
Elevadores para raíces
Leve

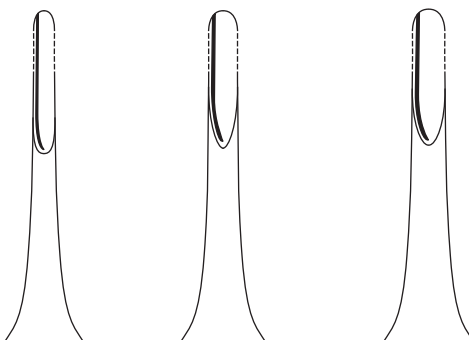

	Fig. 85	Fig. 86	Fig. 87
150 mm - 5¾"	tk 70220-01	tk 70220-02	tk 70220-03

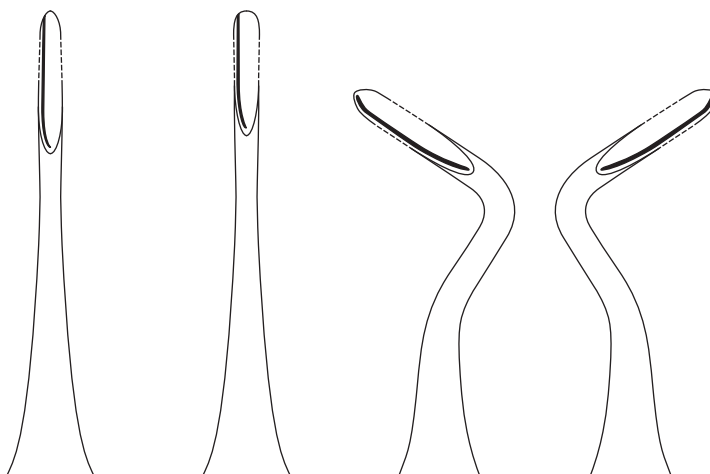
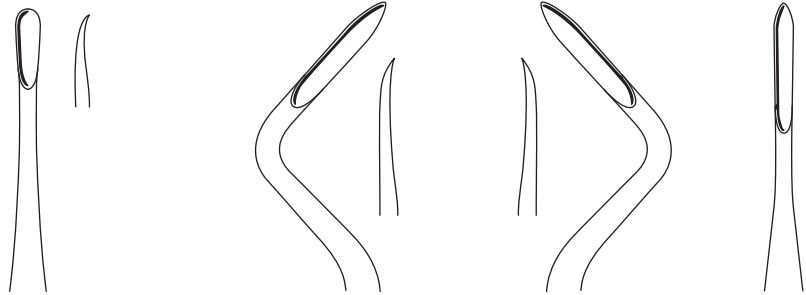

	Fig. 85U	Fig. 85B	Fig. 86L	Fig. 86R
150 mm - 5¾"	tk 70220-04	tk 70220-05	tk 70220-06	tk 70220-07

Wurzelheber | Elévateurs à racines
 Root elevators | Elevadores para raíces
 Leve



APICAL

	Fig. 301	Fig. 302	Fig. 303	Fig. 304
160 mm - 6 1/4"	tk 70206-01	tk 70206-02	tk 70206-03	tk 70206-04

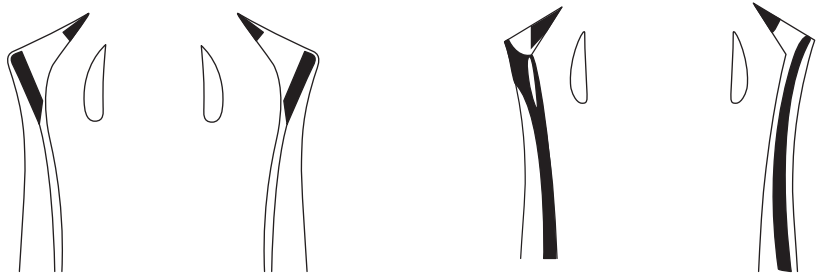

CRYER

	Fig. 27	Fig. 28	Fig. 39	Fig. 40
160 mm - 6 1/4"	tk 70207-27	tk 70207-28	tk 70207-39	tk 70207-40

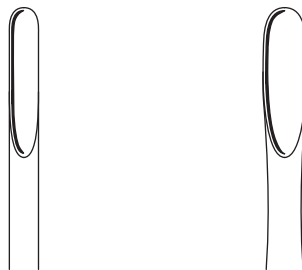

SELDIN

	Fig. 34	Fig. 34 S
160 mm - 6 1/4"	tk 70208-34	tk 70208-34 S



Wurzelheber
Root elevators

Elévateurs à racines
Elevadores para raíces
Leve

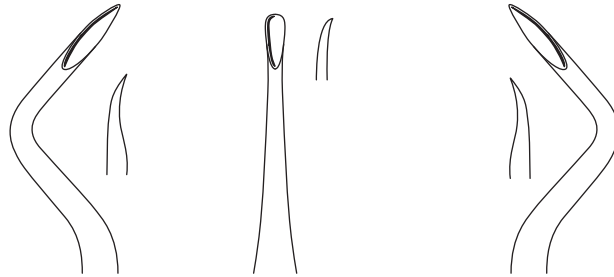

FRIEDMANN

	Fig. 1	Fig. 2	Fig. 3
145 mm - 5½"	tk 70210-02	tk 70210-01	tk 70210-03

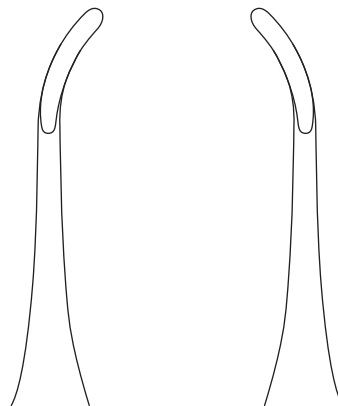

MILLER

160 mm - 6¼"	tk 70205-04	tk 70205-05
--------------	--------------------	--------------------



Wurzelheber
Root elevators

Elévateurs à racines
Elevadores para raíces
Leve

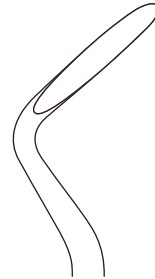

HYLIN

	Fig. 1	Fig. 2	Fig. 3	Fig. 4
	4.5 mm	3 mm	3 mm	3 mm
140 mm - 5½"	tk 70211-01	tk 70211-02	tk 70211-03	tk 70211-04

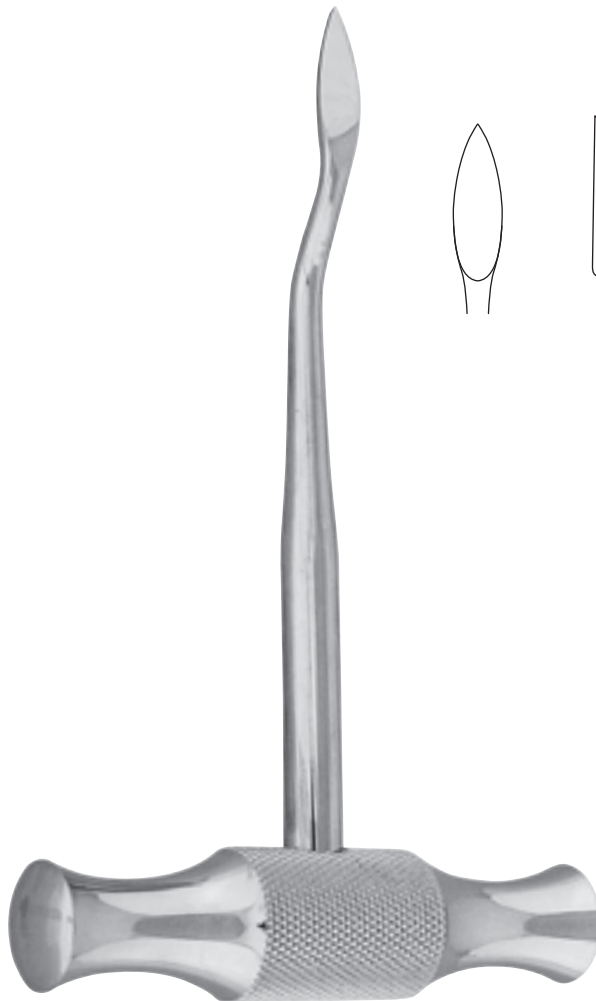

LECLUSE

130 mm - 5"	tk 70215-00
-------------	--------------------

Wurzelheber
Root elevators

Elévateurs à racines
Elevadores para raíces
Leve

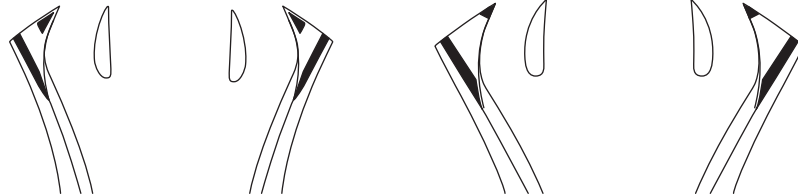

BARRY

	Fig. 320	Fig. 321	Fig. 322	Fig. 323
120 mm - 4¾"	tk 70213-20	tk 70213-21	tk 70213-22	tk 70213-23



BARRY

	Fig. 370	Fig. 371
130 mm - 5¼"	tk 70213-70	tk 70213-71

Wurzelheber
Root elevators

Elévateurs à racines
Elevadores para raíces
Leve

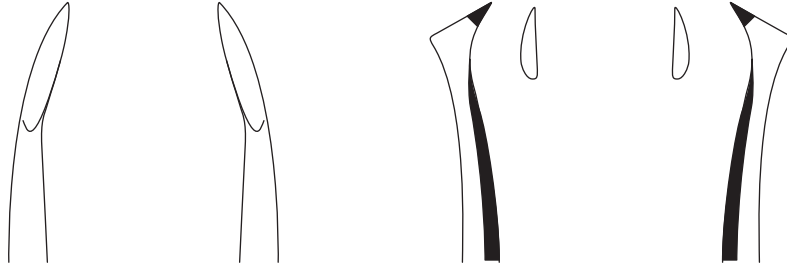

WINTER

	Fig. 1 L	Fig. 1 R	Fig. 11 L	Fig. 11 R
110 mm - 4¼"	tk 70217-01 L	tk 70217-01 R	tk 70217-11 L	tk 70217-11 R

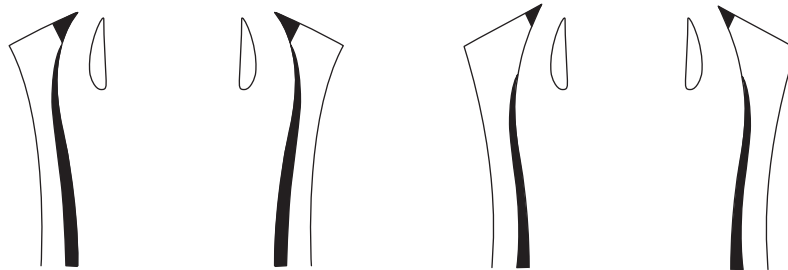

WINTER

	Fig. 12 L	Fig. 12 R	Fig. 13 L	Fig. 13 R
110 mm - 4¼"	tk 70217-12 L	tk 70217-12 R	tk 70217-13 L	tk 70217-13 R

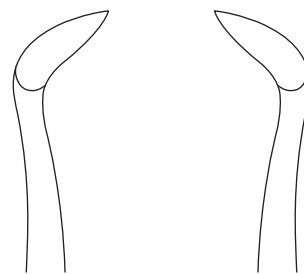

WINTER

	Fig. 370	Fig. 371
110 mm - 4¼"	tk 70217-14 L	tk 70217-14 R

Wurzelheber
Root elevators

Elévateurs à racines
Elevadores para raíces
Leve

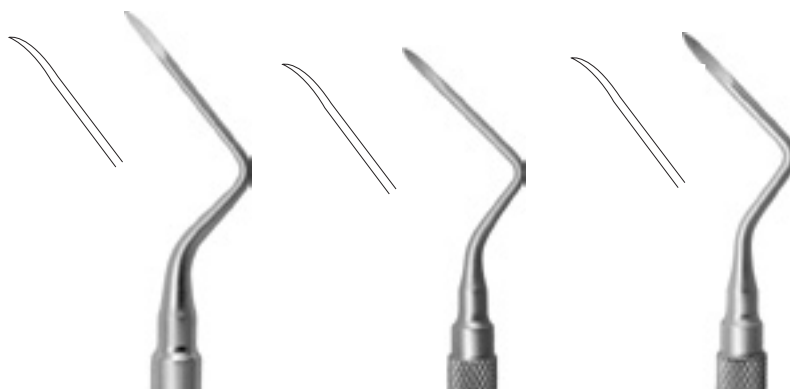

HEIDBRINK

	1.7 mm	2.1 mm	2.5 mm
190 mm - 7 3/4"	tk 71020-11	tk 71020-12	tk 71020-13

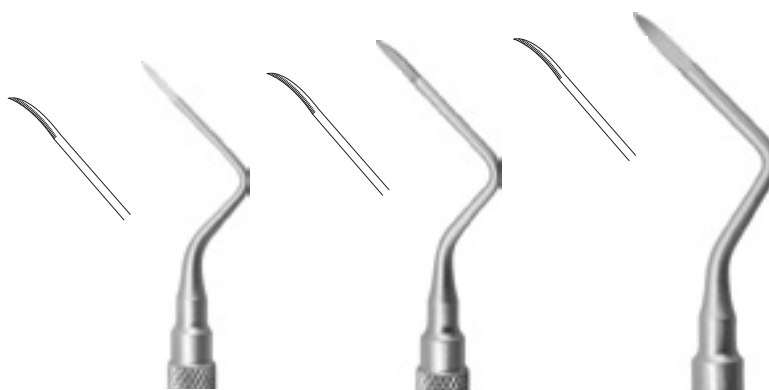

HEIDBRINK

	1.7 mm	2.1 mm	2.5 mm
190 mm - 7 3/4"	tk 71020-14	tk 71020-15	tk 71020-16

gezahnt
saw edge

Wurzelheber | Elévateurs à racines
Root elevators | Elevadores para raíces
Leve

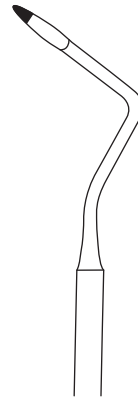
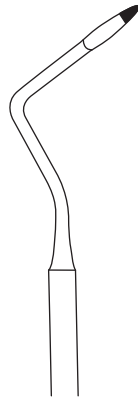

HEIDBRINK

	Fig. 1	Fig. 2	Fig. 3
175 mm - 7"	tk 71020-01	tk 71020-02	tk 71020-03

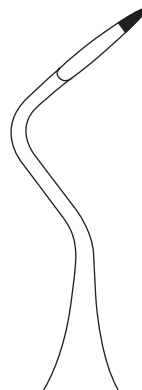

HEIDBRINK

	2 Ø	2 Ø
140 mm - 5½"	tk 71020-08	tk 71020-09



Syndesmotome, Wurzelschrauben
 Syndesmotomes, Root screws

Syndesmotomes, Vis à racines
 Sindesmotomos, Tornillos para raíces
 Syndesmotomi, Viti per radici



MORRISON

	Fig. 0	Fig. 1	Fig. 2	Fig. 3
115 mm - 4½"	tk 71018-00	tk 71018-01	tk 71018-02	tk 71018-03

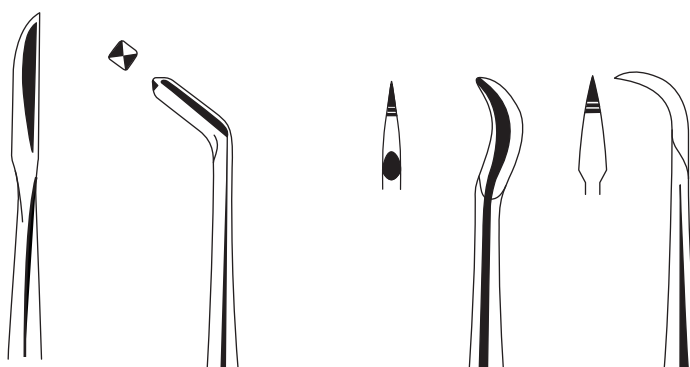
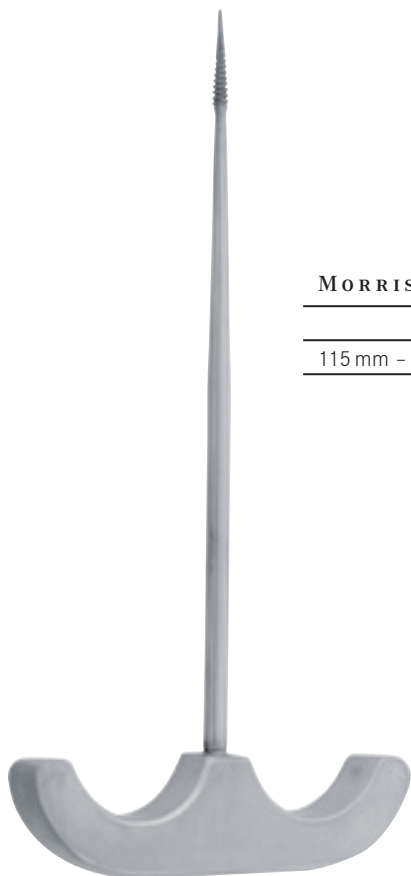

CHOMPRET

	Fig. 1	Fig. 2	Fig. 3	Fig. 4
160 mm - 6¼"	tk 70219-41	tk 70219-42	tk 70219-43	tk 70219-44



Zahnzangen, englische Form
Extracting forceps, english pattern

Daviers, forme anglaise
Forceps de extracción, forma inglesa
Pinze da estrazione, forma inglese

STANDARD

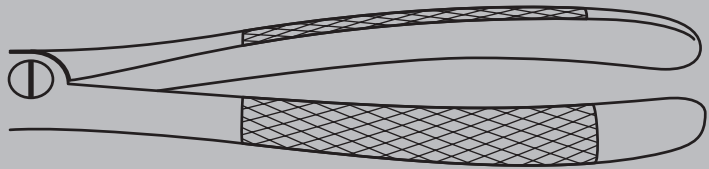
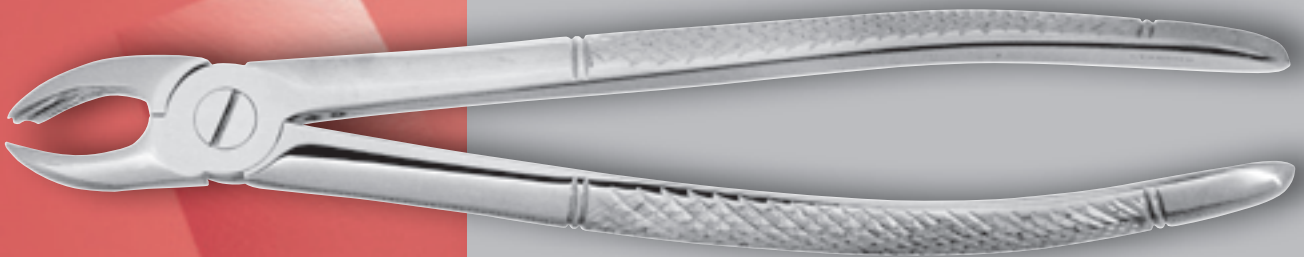

bewährte Griffform mit Kleinkaro auf den Griffflächen für sicheren, rutschfreien Halt
Standard handle with cross serrated sections for secure grip

Manche éprouvé à petits carreaux pour un tenu sur et non-glissant.

Forma de mango probada con superficie cuadrículada antideslizante.

Forma di manico affermato con superficie zigrinato a quadretto per una presa sicura ed antiscivola.

FORMTK

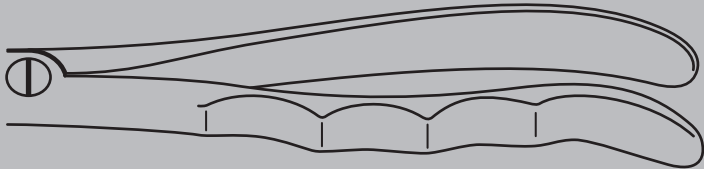
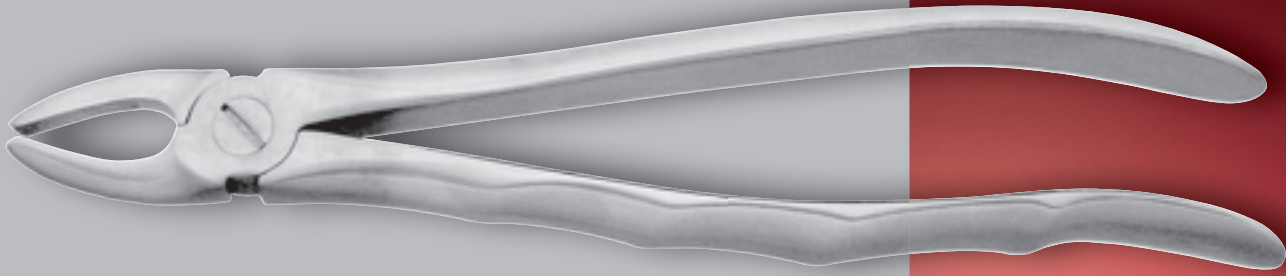

Die Ergonomie des Griffes garantiert festen Halt und schont die Handmuskeln
The ergonomic handle guarantees fix grip and comfortable use

L'ergonomie du manche garantit un tenu sur et ménage les muscles de la main.

La ergonomía del mango garantiza un soporte fijo y cuida los músculos de la mano.

L'ergonomia del manico garantisce una presa sicura non affaticando tanto i muscoli della mano.

LIGHTTK

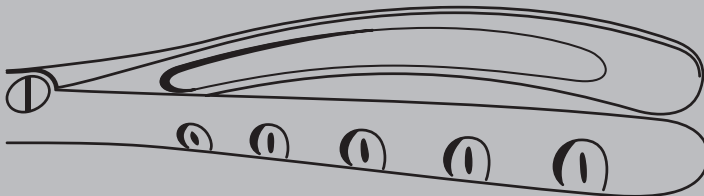
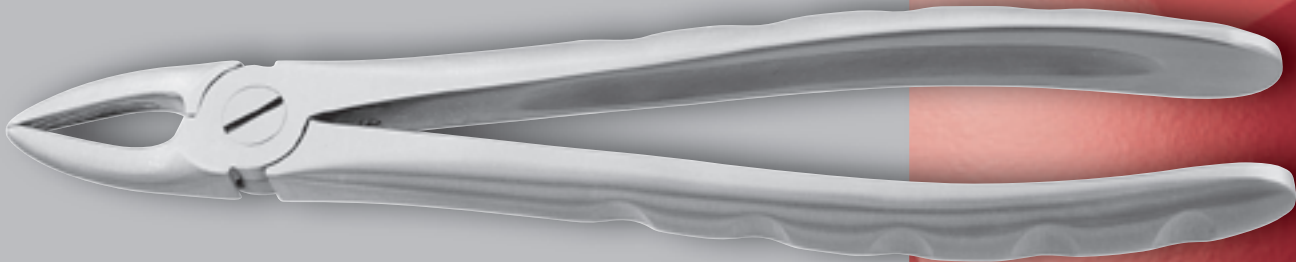

Durch Aushöhlung der Griffbranchen verringert sich das Gewicht der Zange. Die grosskerbigen Griffflächen garantieren sicheren Halt.
The perforated handles reduce the weight and guarantee a secure grip.

The perforated handles reduce the weight and guarantee a secure grip.

Le poids du manche est réduit en évidant et racourçant les branches. Ces surfaces garantissent un tenu sur.

Ahueccar el mango y la reduccion parcial de la longitud total reduce el peso de la pinza.

Los entalladuras grandes garantizan un soporte fijo.

Le branche del manico sono savate ed in parte piu corte nella lunghezza totale e si riduce il peso della pinza. Tacche relalivamente grande garantisconouna presa sicurra.

Zahnzangen, englische Form
Extracting forceps, english pattern

Daviers, forme anglaise
Forceps de extracción, forma inglesa
 Pinze da estrazione, forma inglese

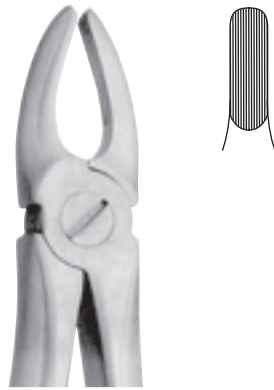

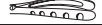

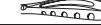

		Fig. 1
	170 mm - 6¾"	tk 70100-01
	170 mm - 6¾"	tk 70106-01
	170 mm - 6¾"	tk 70102-01



obere Schneide- und Eckzähne
upper centrals and canines



		Fig. 2
	170 mm - 6¾"	tk 70100-02
	170 mm - 6¾"	tk 70106-02
	170 mm - 6¾"	tk 70102-02

obere Schneide- und Eckzähne
upper centrals and canines

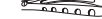

		Fig. 7
	160 mm - 6½"	tk 70100-07
	160 mm - 6½"	tk 70106-07
	160 mm - 6½"	tk 70102-07

obere Prämolaren
upper premolars

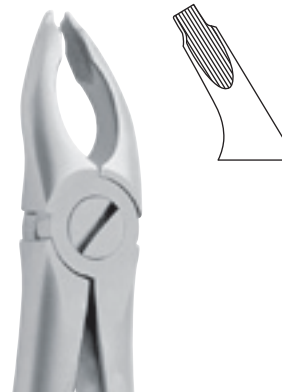

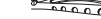

		Fig. 35 A
	160 mm - 6½"	-
	160 mm - 6½"	tk 70104-35 A
	160 mm - 6½"	-

obere Prämolaren
upper premolars

Zahnzangen, englische Form
Extracting forceps, english pattern

Daviers, forme anglaise
Forceps de extracción, forma inglesa
 Pinze da estrazione, forma inglese

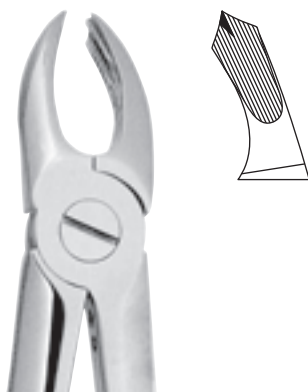

		Fig. 17
	170 mm - 6 3/4"	tk 70100-17
	180 mm - 7"	tk 70106-17
	170 mm - 6 3/4"	tk 70102-17

		Fig. 18
	170 mm - 6 3/4"	tk 70100-18
	170 mm - 6 3/4"	tk 70106-18
	170 mm - 6 3/4"	tk 70102-18

obere Molaren, rechts
upper molars, right

obere Molaren, links
upper molars, left

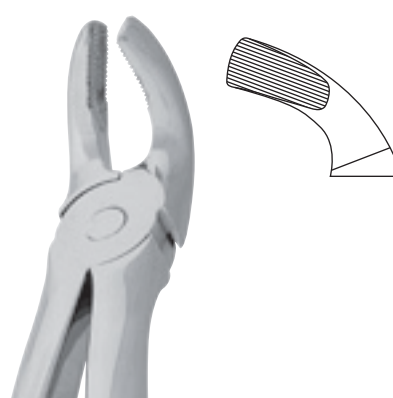
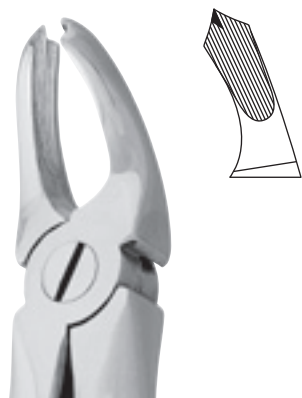
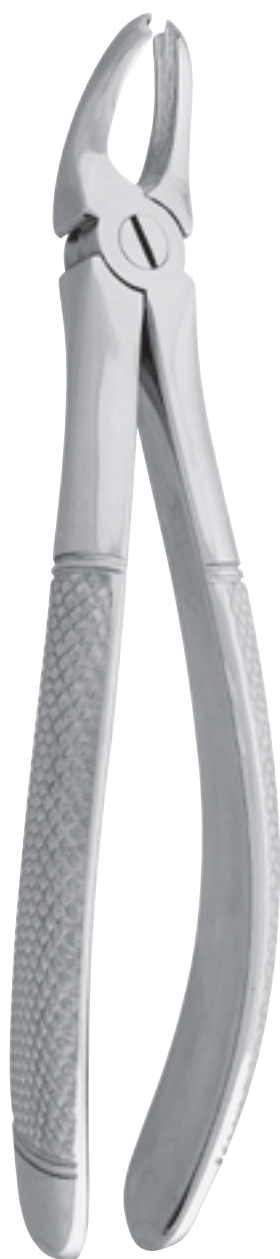

		Fig. 18 A
	170 mm - 6 3/4"	tk 70100-18 A
	-	-
	-	-

		Fig. 19
	170 mm - 6 3/4"	tk 70100-19
	-	-
	-	-

obere Molaren
upper molars

obere dritte Molaren
upper third molars

Zahnzangen, englische Form
Extracting forceps, english pattern

Daviers, forme anglaise
Forceps de extracción, forma inglesa
Pinze da estrazione, forma inglese

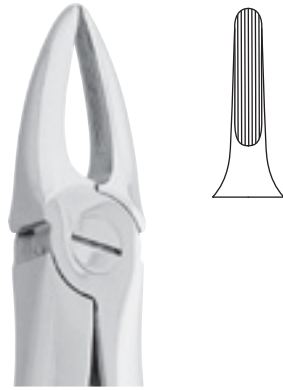

		Fig. 29
	170 mm - 6¾"	tk 70100-29
	-	-
	-	-

obere Wurzeln
upper roots

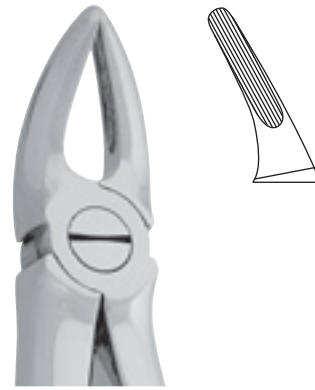

		Fig. 30
	170 mm - 6¾"	tk 70100-30
	-	-
	-	-

obere Wurzeln
upper roots



		Fig. 34
	-	-
	160 mm - 6½"	tk 70106-34
	-	-

obere Wurzeln
upper roots

Zahnzangen, englische Form
Extracting forceps, english pattern

Daviers, forme anglaise
Forceps de extracción, forma inglesa
 Pinze da estrazione, forma inglese

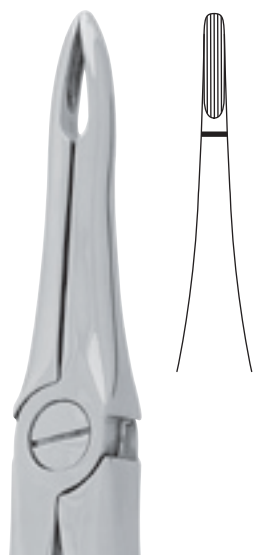

		Fig. 41
	185 mm - 7 1/4"	tk 70100-41
	-	-
	-	-

obere Wurzeln
upper roots



		Fig. 44
	185 mm - 7 1/4"	tk 70100-44
	-	-
	-	-

obere Wurzeln
upper roots



		Fig. 49
	190 mm - 7 1/2"	tk 70100-49
	185 mm - 7 1/4"	tk 70106-49
	-	-

obere Wurzeln
upper roots

Zahnzangen, englische Form
Extracting forceps, english pattern

Daviers, forme anglaise
Forceps de extracción, forma inglesa
Pinze da estrazione, forma inglese



		Fig. 51
	185 mm - 7¼"	tk70100-51
	-	-
	-	-

obere Wurzeln
upper roots

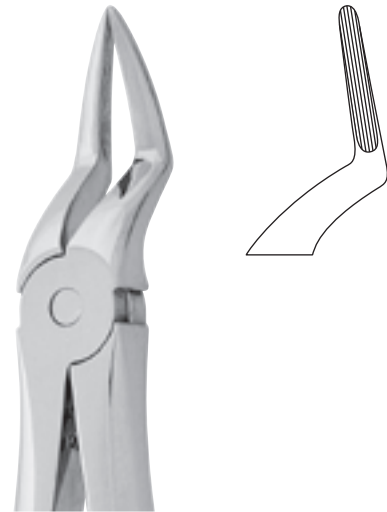

		Fig. 51 A
	185 mm - 7¼"	tk70100-51 A
	170 mm - 6¾"	tk70106-51 A
	185 mm - 7¼"	tk70102-51 A

obere Wurzeln
upper roots

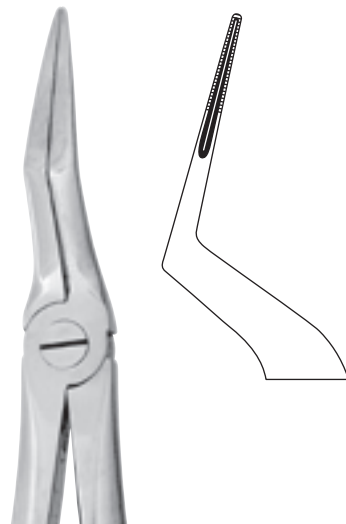

		Fig. 51 LX
	190 mm - 7½"	tk70104-51 LX
	-	-
	-	-

obere Wurzeln
upper roots



		Fig. 51 B
	-	-
	170 mm - 6¾"	tk70106-51 B
	-	-

obere Wurzeln
upper roots

Zahnzangen, englische Form
Extracting forceps, english pattern

Daviers, forme anglaise
Forceps de extracción, forma inglesa
 Pinze da estrazione, forma inglese



		Fig. 66 R
	170 mm - 6¾"	tk 70100-66 R
	170 mm - 6¾"	tk 70106-66 R
	-	-

obere Molaren, rechts
upper molars, right

		Fig. 66 L
	170 mm - 6¾"	tk 70100-66 L
	170 mm - 6¾"	tk 70106-66 L
	-	-

obere Molaren, links
upper molars, left

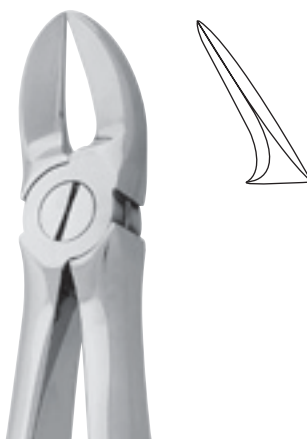

		Fig. 55
	170 mm - 6¾"	tk 70100-55
	-	-
	-	-

Spaltzange für obere Molaren
separating forceps for upper molars

Zahnzangen, englische Form
Extracting forceps, english pattern

Daviers, forme anglaise
Forceps de extracción, forma inglesa
Pinze da estrazione, forma inglese

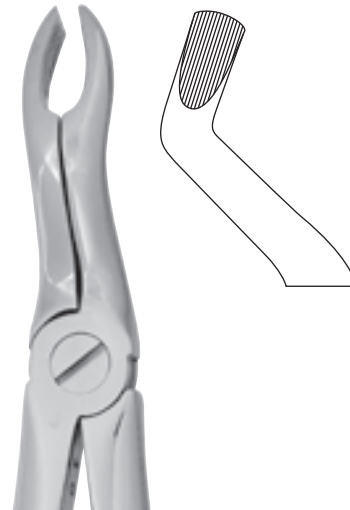

		Fig. 67
	180 mm - 7"	tk 70100-67
	-	-
	-	-

obere dritte Molaren
upper third molars

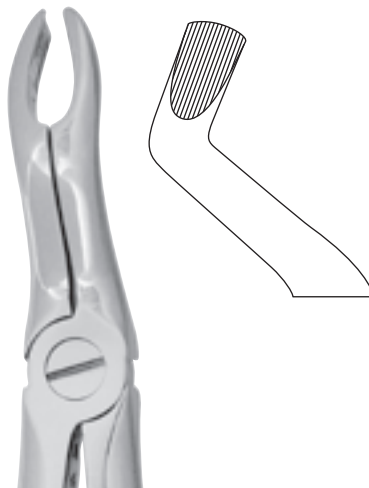

		Fig. 67 A
	180 mm - 7"	tk 70100-67 A
	180 mm - 7"	tk 70106-67 A
	180 mm - 7"	tk 70102-67 A

obere dritte Molaren
upper third molars

Zahnzangen, englische Form
Extracting forceps, english pattern

Daviers, forme anglaise
Forceps de extracción, forma inglesa
 Pinze da estrazione, forma inglese

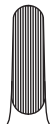
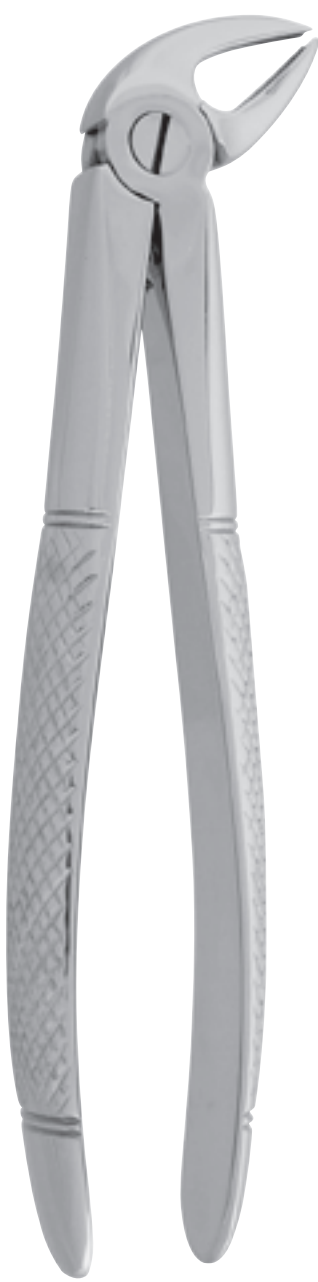

		Fig. 4
	165 mm - 6½"	tk 70100-04
	165 mm - 6½"	tk 70106-04
	165 mm - 6½"	tk 70102-04

untere Schneide- und Eckzähne
lower incisors and canines



		Fig. 13
	155 mm - 6"	tk 70100-13
	170 mm - 6¾"	tk 70106-13
	155 mm - 6"	tk 70102-13

untere Prämolaren
lower premolars

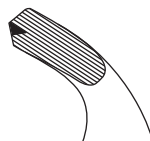

		Fig. 21
	165 mm - 6½"	tk 70100-21
	-	-
	-	-

untere Molaren
lower molars

Zahnzangen, englische Form
Extracting forceps, english pattern

Daviers, forme anglaise
Forceps de extracción, forma inglesa
Pinze da estrazione, forma inglese



		Fig. 22
	155 mm - 6"	tk 70100-22
	160 mm - 6½"	tk 70106-22
	155 mm - 6"	tk 70102-22

untere Molaren
lower molars

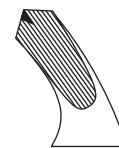

		Fig. 24
	155 mm - 6"	tk 70100-24
	-	-
	-	-

untere Molaren, links
lower molars, left



		Fig. 23
	155 mm - 6"	tk 70100-23
	-	-
	-	-

untere Molaren, rechts
lower molars, right

Zahnzangen, englische Form
Extracting forceps, english pattern

Daviers, forme anglaise
Forceps de extracción, forma inglesa
 Pinze da estrazione, forma inglese

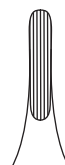
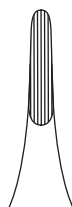

		Fig. 33 L
	155 mm - 6"	tk 70100-33 L
	-	-
	-	-

untere Wurzeln
lower roots

		Fig. 33
	155 mm - 6"	tk 70100-33
	160 mm - 6½"	tk 70106-33
	155 mm - 6"	tk 70102-33

untere Wurzeln
lower roots



		Fig. 36
	-	-
	155 mm - 6"	tk 70106-36
	-	-

untere Wurzeln
lower roots

		Fig. 73
	155 mm - 6"	tk 70100-73
	-	-
	-	-

untere Molaren
lower molars

Zahnzangen, englische Form
Extracting forceps, english pattern

Daviers, forme anglaise
Forceps de extracción, forma inglesa
Pinze da estrazione, forma inglese



		Fig. 74 N
	150 mm - 5¾"	tk 70100-74 N
	-	-
	-	-

untere Wurzeln
lower roots

		Fig. 74
	150 mm - 5¾"	tk 70100-74
	150 mm - 5¾"	tk 70106-74
	150 mm - 5¾"	tk 70102-74

untere Schneide- und Eckzähne
lower incisors and canines



		Fig. 75
	150 mm - 5¾"	tk 70100-75
	-	-
	-	-

untere Prämolaren
lower premolars



		Fig. 45
	185 mm - 7¼"	tk 70100-45
	-	-
	-	-

untere Wurzeln
lower roots

Zahnzangen, englische Form
Extracting forceps, english pattern

Daviers, forme anglaise
Forceps de extracción, forma inglesa
 Pinze da estrazione, forma inglese



		Fig. 68
	175 mm - 7"	tk 70100-68
	-	-
	-	-

untere Wurzeln
lower roots

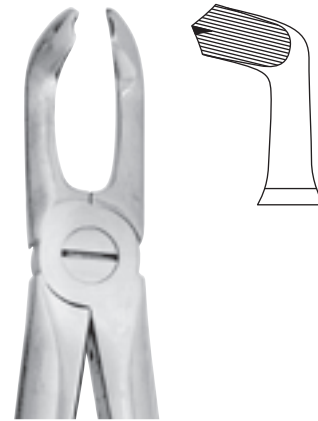

		Fig. 79
	170 mm - 6¾"	tk 70100-79
	170 mm - 6¾"	tk 70106-79
	170 mm - 6¾"	tk 70102-79

untere dritte Molaren
lower third molars

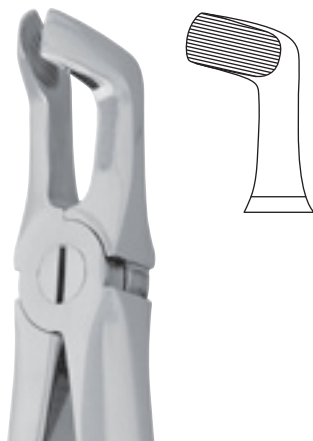

		Fig. 79 A
	170 mm - 6¾"	tk 70100-79 A
	-	-
	-	-

untere dritte Molaren
lower third molars



		Fig. 79 C
	170 mm - 6¾"	tk 70100-79 C
	170 mm - 6¾"	tk 70106-79 C
	-	-

untere dritte Molaren
lower third molars

Zahnzangen, englische Form
Extracting forceps, english pattern

Daviers, forme anglaise
Forceps de extracción, forma inglesa
Pinze da estrazione, forma inglese

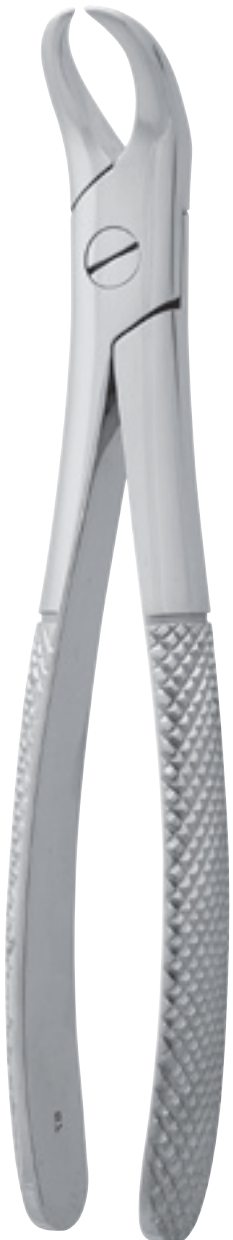

		Fig. 86 A
	150 mm - 5¾"	tk 70100-86 A
	-	-
	-	-

untere Molaren
lower molars



		Fig. 86 B
	150 mm - 5¾"	tk 70100-86 B
	-	-
	-	-

untere Molaren
lower molars



		Fig. 86 C
	150 mm - 5¾"	tk 70100-86 C
	-	-
	-	-

untere Molaren
lower molars



		Fig. 87
	170 mm - 6¾"	tk 70100-87
	-	-
	-	-

untere Molaren
lower molars

Weisheitszahnzangen
Wisdom teeth extracting forceps

Daviers pour dents de sagesse
Forceps de extracción para cordales
 Pinze d'estrazione per ottavo



		Fig. 22 1/2 L
	180 mm - 5 1/2"	tk 70104-22 L
	170 mm - 6 3/4"	tk 70106-08 L
	-	-

Molaren und Weisheitszähne, unten links
lower molars and wisdoms, left

		Fig. 22 1/2 R
	180 mm - 5 1/2"	tk 70104-22 R
	170 mm - 6 3/4"	tk 70106-08 R
	-	-

Molaren und Weisheitszähne, unten rechts
lower molars and wisdoms, right

Zahnzangen, englische Form
Extracting forceps, english pattern

Daviers, forme anglaise
Forceps de extracción, forma inglesa
Pinze da estrazione, forma inglese



WHITE

170 mm - 6 3/4"	tk 70104-00
-----------------	--------------------

Spaltzange
separating forceps



Fig. 59 L

150 mm - 5 3/4"	tk 70104-59 L
-----------------	----------------------



Fig. 56

170 mm - 6 3/4"	tk 70100-56
-----------------	--------------------

Spaltzange für untere Molaren
separating forceps for lower molars

Zahnzangen, englische Form
Extracting forceps, english pattern

Daviers, forme anglaise
Forceps de extracción, forma inglesa
 Pinze da estrazione, forma inglese

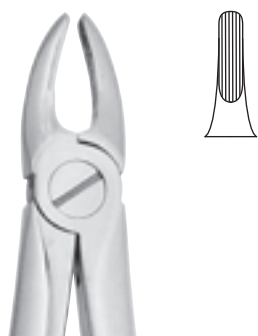

	Fig. 37
135 mm - 5½"	tk 70110-37

obere Schneidezähne, für Kinder
upper incisors, for children

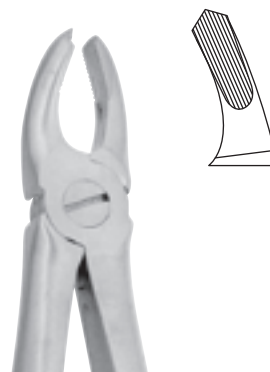

	Fig. 39 R
135 mm - 5½"	tk 70110-39 R

obere Molaren rechts, für Kinder
upper molars right, for children

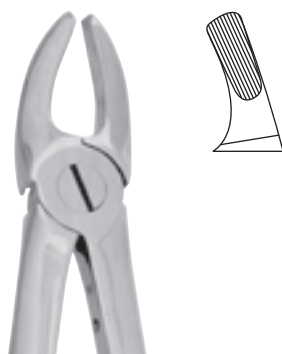

	Fig. 39
135 mm - 5½"	tk 70110-39

obere Molaren, für Kinder
upper molars, for children

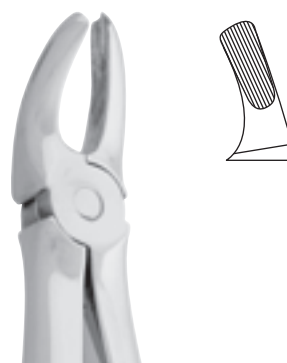

	Fig. 39 L
135 mm - 5½"	tk 70110-39 L

obere Molaren links, für Kinder
upper molars left, for children

Kinderzahnzangen, englische Form
Extracting forceps for children, english pattern

Daviers pour enfants, forme anglaise
Forceps para niños de extracción, forma inglesa
Pinze da estrazione per bambini, forma inglese

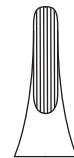
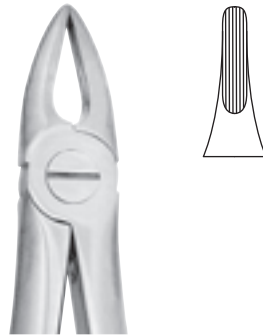

	Fig. 29 S
135 mm - 5½"	tk70110-29 S

obere Wurzeln, für Kinder
upper roots, for children

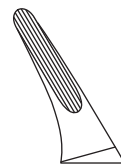
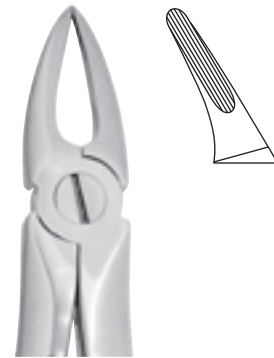

	Fig. 30 S
135 mm - 5½"	tk70110-30 S

obere Wurzeln, für Kinder
upper roots, for children

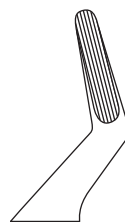
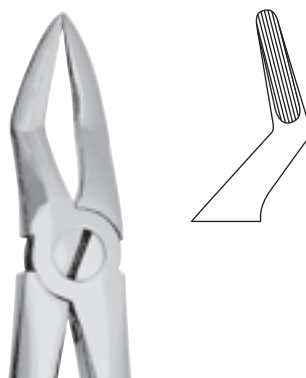

	Fig. 51 S
135 mm - 5½"	tk70110-51 S

obere Wurzeln, für Kinder
upper roots, for children

Kinderzahnzangen, englische Form
Extracting forceps for children, english pattern

Daviers pour enfants, forme anglaise
Forceps para niños de extracción, forma inglesa
 Pinze da estrazione per bambini, forma inglese

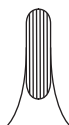

	Fig. 13 S
130 mm - 5¼"	tk 70110-13 S

untere Prämolaren, für Kinder
lower premolars, for children



	Fig. 22 S
130 mm - 5¼"	tk 70110-22 S

untere Molaren, für Kinder
lower molars, for children

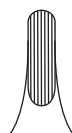

	Fig. 33 S
130 mm - 5¼"	tk 70110-33 S

untere Wurzeln, für Kinder
lower roots, for children



	Fig. 38
135 mm - 5¼"	tk 70110-38

untere Schneide- und Eckzähne, für Kinder
lower incisors and canines, for children

Kinderzahnzangen, englische Form
Extracting forceps for children, english pattern

Daviers pour enfants, forme anglaise
Forceps para niños de extracción, forma inglesa
Pinze da estrazione per bambini, forma inglese



KLEIN	
	Fig. 137
115 mm - 4½"	tk 70111-137



KLEIN	
	Fig. 139
115 mm - 4½"	tk 70111-139

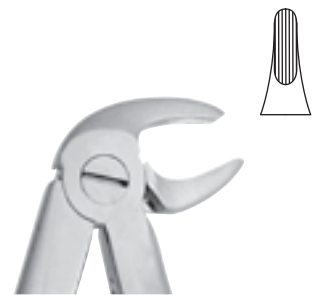

KLEIN	
	Fig. 5
105 mm - 4"	tk 70111-05



KLEIN	
	Fig. 6
105 mm - 4"	tk 70111-06

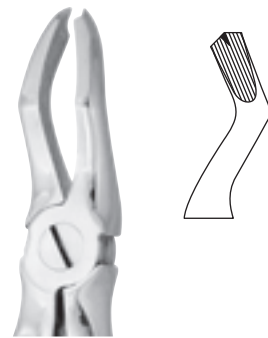

KLEIN	
	Fig. 3
110 mm - 4¼"	tk 70111-03



KLEIN	
	Fig. 7
105 mm - 4"	tk 70111-07

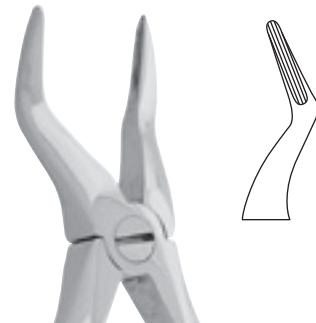

KLEIN	
	Fig. 51 S
110 mm - 4¼"	tk 70111-51S

Kinderzahnzangen, englische Form
Extracting forceps for children, english pattern

Daviers pour enfants, forme anglaise
Forceps para niños de extracción, forma inglesa
 Pinze da estrazione per bambini, forma inglese

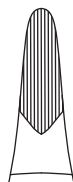

MEAD

	Fig. MD 1
170 mm - 6¾"	tk 70105-01 MD

obere Frontzähne, Wurzeln
upper anterios, roots

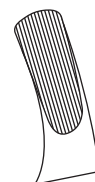

MEAD

	Fig. MD 2
170 mm - 6¾"	tk 70105-02 MD

obere Molaren
upper molars

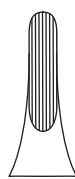

MEAD

	Fig. MD 3
160 mm - 6½"	tk 70105-03 MD

untere Wurzeln
lower roots



MEAD

	Fig. MD 4
160 mm - 6½"	tk 70105-04 MD

untere Molaren
lower molars

Zahnzangen, amerikanische Form
Extracting forceps, american pattern

Daviers, forme américaine
Forceps de extracción, forma americana
Pinze da estrazione, forma americana

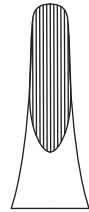

HENAHAN

	Fig. 1 A
190 mm - 7½"	tk 70120-01 A

obere Schneidezähne
upper incisors

	Fig. 1 B
190 mm - 7½"	tk 70120-01 B

obere Schneidezähne und Wurzeln
upper incisors and roots

STANDARD

	Fig. 1
190 mm - 7½"	tk 70120-01

obere Schneide- und Eckzähne
upper incisors and canines

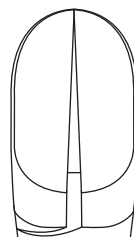

PHYSIK

	Fig. 6
190 mm - 7½"	tk 70120-06

Spaltzange
separating forceps

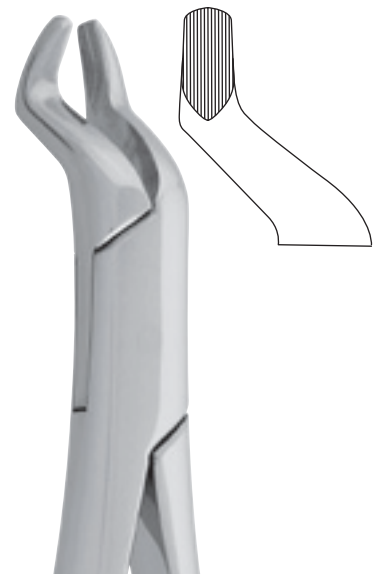

	Fig. 10 S
190 mm - 7½"	tk 70120-10 S

obere Molaren
upper molars

Zahnzangen, amerikanische Form
Extracting forceps, american pattern

Daviers, forme américaine
Forceps de extracción, forma americana
 Pinze da estrazione, forma americana

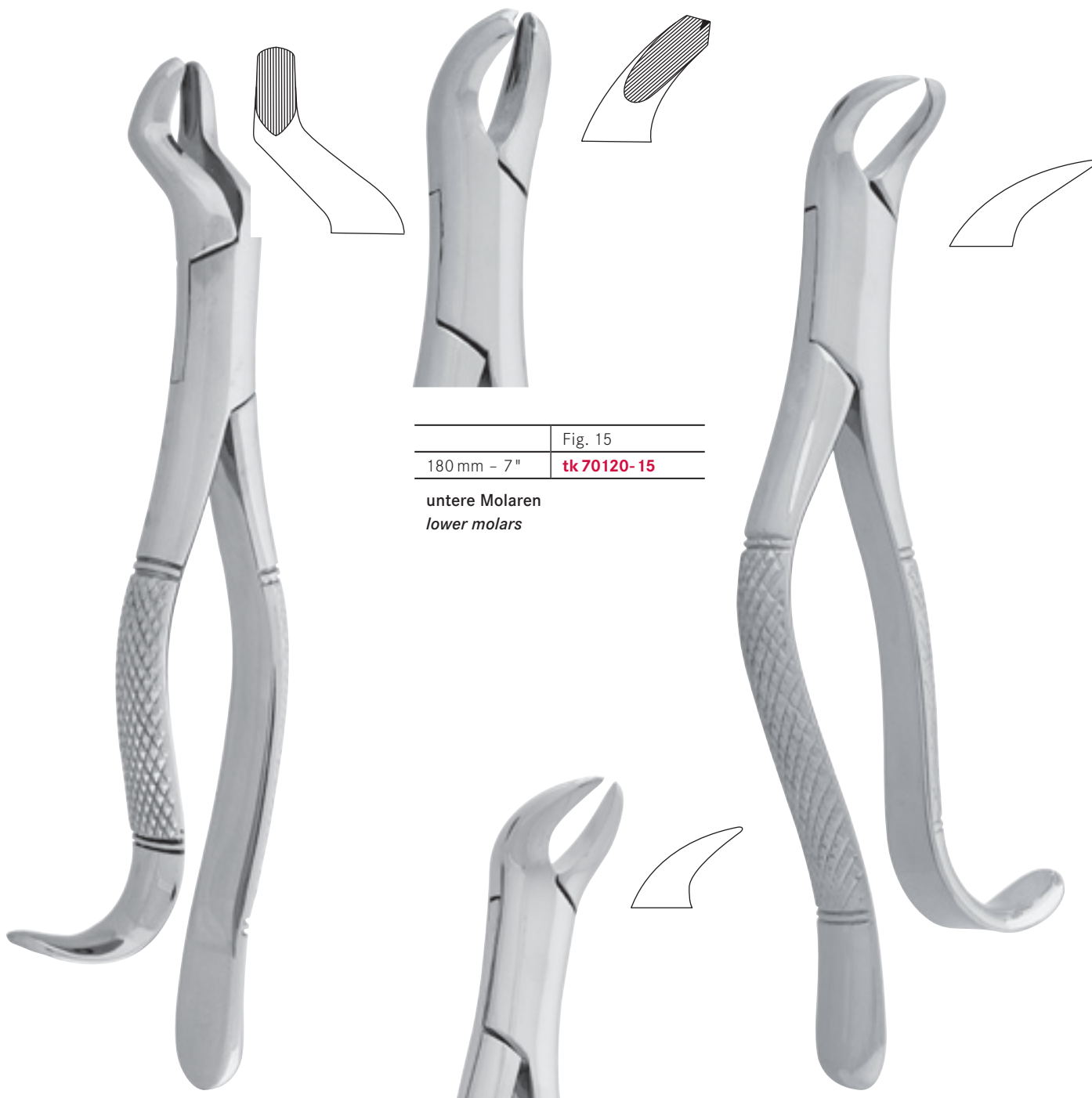

	Fig. 15
180 mm - 7"	tk 70120-15

untere Molaren
lower molars

	Fig. 10 H
180 mm - 7"	tk 70120-10 H

obere Molaren
upper molars

	Fig. 16 S
180 mm - 7"	tk 70120-16 S

untere Molaren, für Kinder
lower molars, for children

	Fig. 16
175 mm - 6¾"	tk 70120-16

untere Molaren
lower molars

Zahnzangen, amerikanische Form
Extracting forceps, american pattern

Daviers, forme américaine
Forceps de extracción, forma americana
Pinze da estrazione, forma americana



	Fig. 17
180 mm - 7"	tk 70120-17

untere Molaren
lower molars



	Fig. 18 L
180 mm - 7"	tk 70120-18 L

obere Molaren, links
upper molars, left

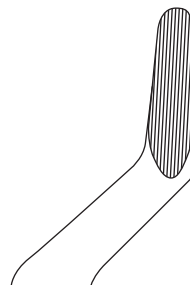
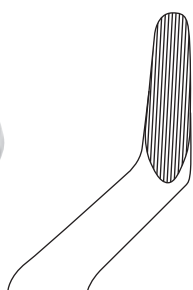

	Fig. 18 R
180 mm - 7"	tk 70120-18 R

obere Molaren, rechts
upper molars, right

Zahnzangen, amerikanische Form
Extracting forceps, american pattern

Daviers, forme américaine
Forceps de extracción, forma americana
 Pinze da estrazione, forma americana



PARMLY

	Fig. 32
180 mm - 7"	tk 70120-32

obere Prämolaren und Molaren
upper premolars and molars

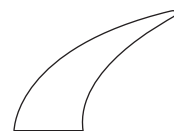

	Fig. 23
180 mm - 7"	tk 70120-23

untere Molaren
lower molars

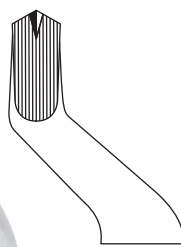
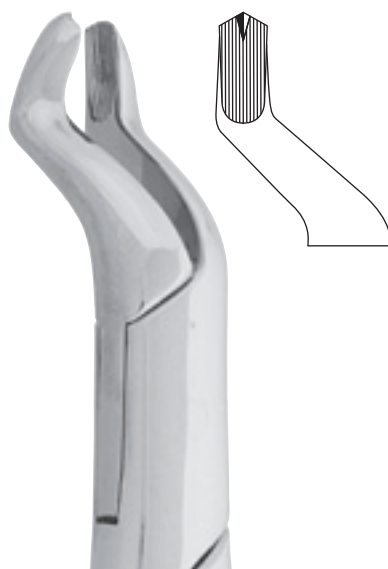

	Fig. 53 R
180 mm - 7"	tk 70120-53 R

obere Molaren, rechts
upper molars, right

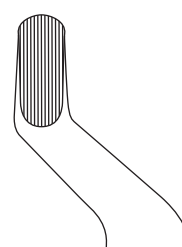

	Fig. 53 L
180 mm - 7"	tk 70120-53 L

obere Molaren, links
upper molars, left

PARMLY

	Fig. 32 A
180 mm - 7"	tk 70120-32 A

obere Prämolaren und Wurzeln
upper premolars and roots

Zahnzangen, amerikanische Form
Extracting forceps, american pattern

Daviers, forme américaine
Forceps de extracción, forma americana
Pinze da estrazione, forma americana

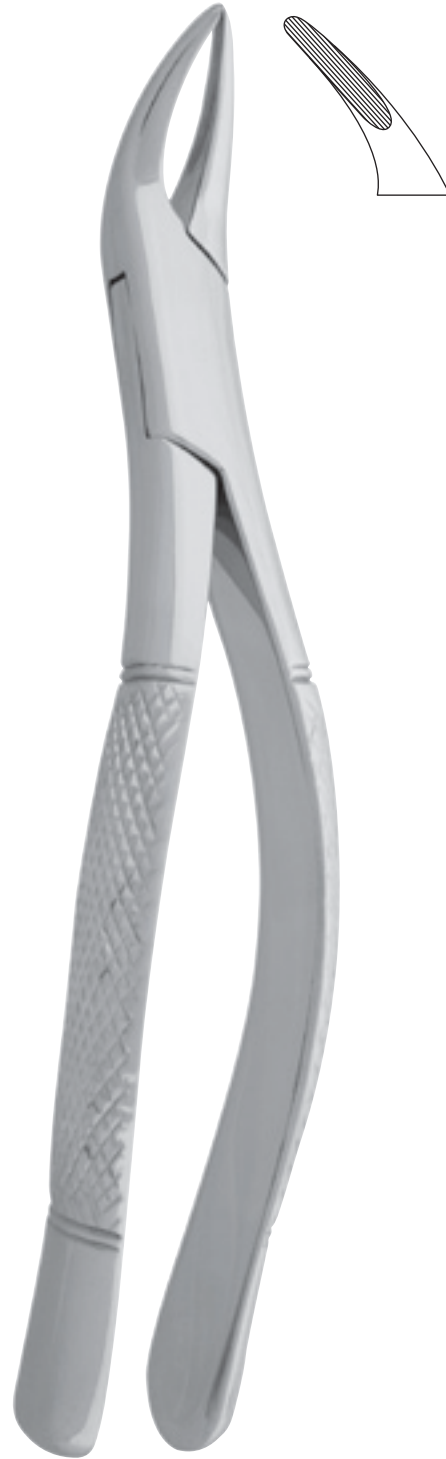

	Fig. 65
180 mm - 7"	tk 70120-65

obere Schneidezähne und Wurzeln
upper incisors and roots

	Fig. 69
180 mm - 7"	tk 70120-69

obere und untere Wurzeln
upper and lower roots

Zahnzangen, amerikanische Form
Extracting forceps, american pattern

Daviers, forme américaine
Forceps de extracción, forma americana
 Pinze da estrazione, forma americana



	Fig. 85
175 mm - 6¾"	tk 70120-85

untere Eckzähne, Prämolaren, Molaren
lower canines, premolars and molars



NEVIUS

	Fig. 88 R
185 mm - 7¼"	tk 70120-88 R

obere Molaren, rechts
upper molars, right



	Fig. 101
160 mm - 6½"	tk 70120-101

Milchzähne
deciduous teeth

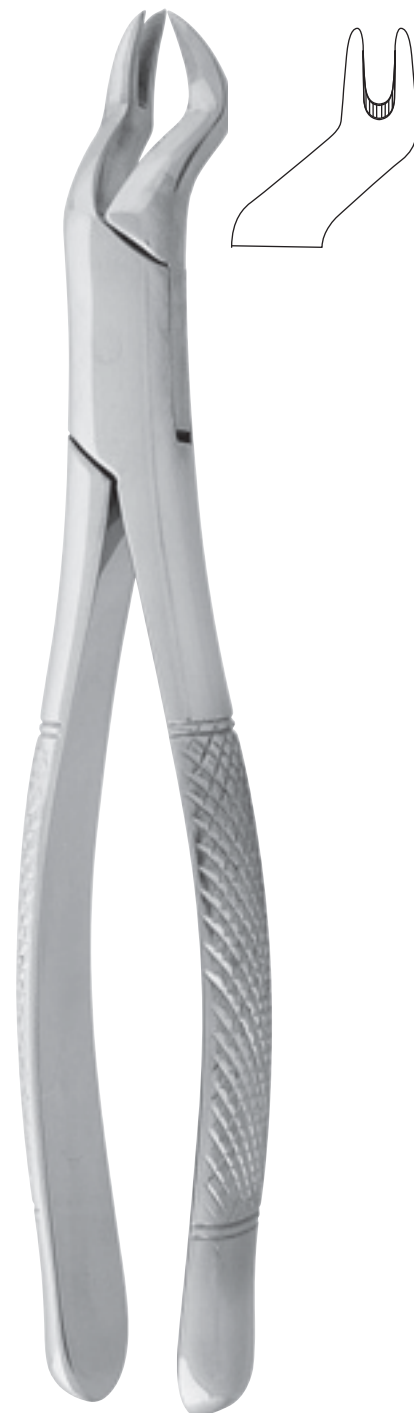

NEVIUS

	Fig. 88 L
185 mm - 7¼"	tk 70120-88 L

obere Molaren, links
upper molars, left

Zahnzangen, amerikanische Form
Extracting forceps, american pattern

Daviers, forme américaine
Forceps de extracción, forma americana
Pinze da estrazione, forma americana



	Fig. 150 A
175 mm - 6¾"	tk 70120-150 A

obere Schneidezähne, Prämolaren und Wurzeln
upper incisors, premolars, roots



	Fig. 150 S
155 mm - 6"	tk 70120-150 S

obere Zähne für Kinder
upper incisors for children

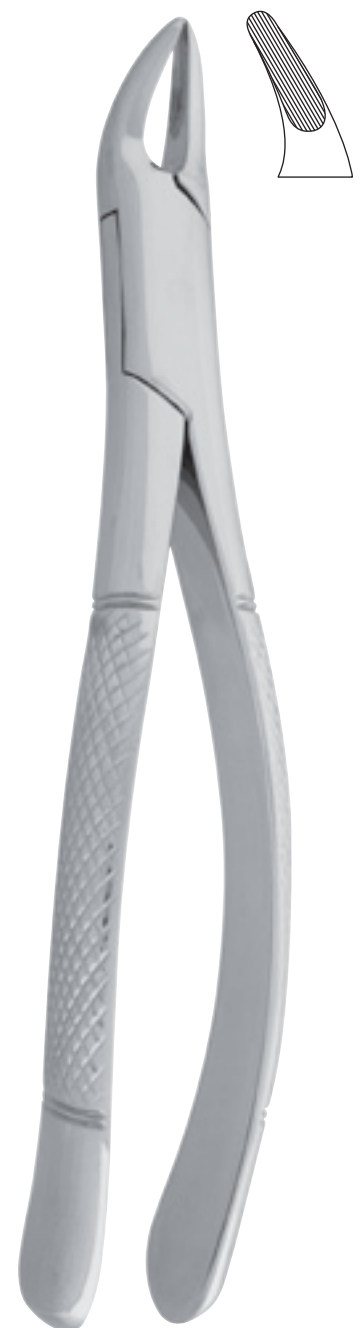

	Fig. 150
175 mm - 6¾"	tk 70120-150

obere Schneidezähne, Prämolaren und Wurzeln
upper incisors, premolars, roots

	Fig. 103
175 mm - 6¾"	tk 70120-103

untere Schneidezähne, Prämolaren
lower incisors, premolars

Zahnzangen, amerikanische Form
Extracting forceps, american pattern

Daviers, forme américaine
Forceps de extracción, forma americana
 Pinze da estrazione, forma americana

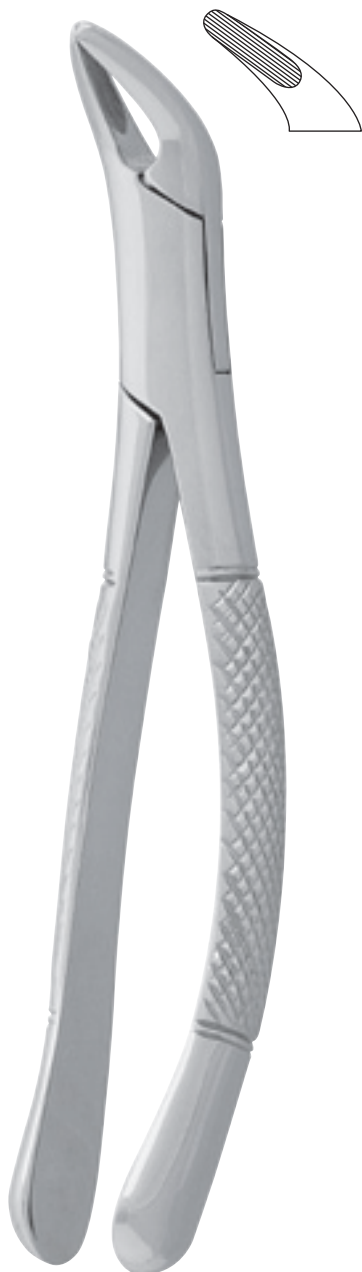

	Fig. 151
180 mm - 7"	tk 70120-151

untere Schneidezähne, Prämolaren und Wurzeln
lower incisors, premolars, roots



	Fig. 151 A
180 mm - 7"	tk 70120-151 A

untere Schneidezähne, Prämolaren und Wurzeln
lower incisors, premolars, roots



	Fig. 151 S
160 mm - 6½"	tk 70120-151 S

untere Zähne für Kinder
lower incisors for children

Zahnzangen, amerikanische Form
Extracting forceps, american pattern

Daviers, forme américaine
Forceps de extracción, forma americana
Pinze da estrazione, forma americana

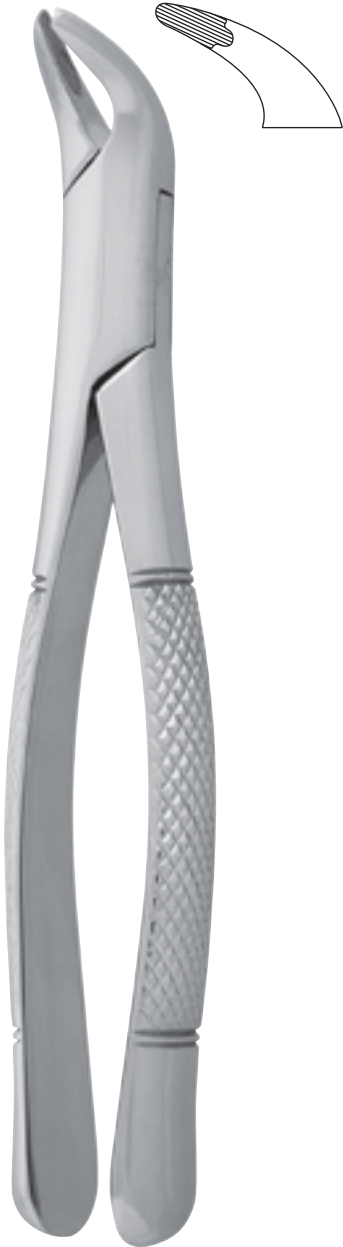

	Fig. 203
170 mm - 6¾"	tk 70120-203
untere Schneidezähne und Wurzeln <i>lower incisors and roots</i>	

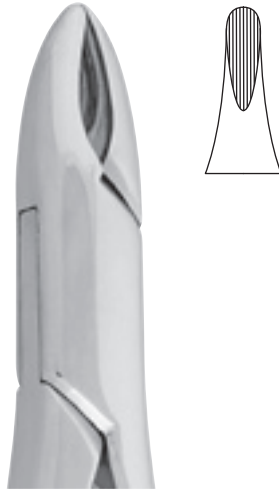

	Fig. 201
170 mm - 6¾"	tk 70120-201
obere Schneide- und Eckzähne, Prämolaren <i>upper incisors, canines, premolars</i>	



	Fig. 210 S
170 mm - 6¾"	tk 70120-210 H
obere dritte Molaren <i>upper third molars</i>	

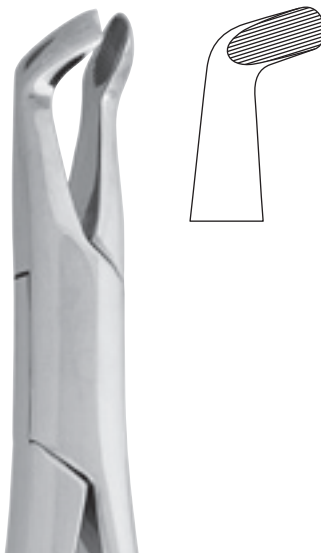

	Fig. 222
180 mm - 7"	tk 70120-222
untere dritte Molaren <i>lower third molars</i>	

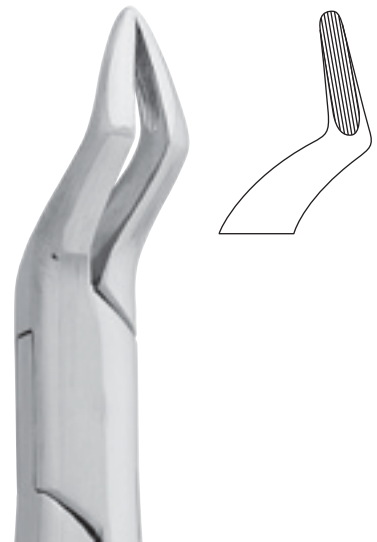

	Fig. 286
180 mm - 7"	tk 70120-286
obere Schneidezähne und Wurzeln <i>upper incisors and roots</i>	

Zahnzangen, amerikanische Form
Extracting forceps, american pattern

Daviers, forme américaine
Forceps de extracción, forma americana
 Pinze da estrazione, forma americana



	Fig. 17 SK
120 mm - 4¾"	tk 70130-17 SK

untere Molaren
lower molars



	Fig. 23 SK
120 mm - 4¾"	tk 70130-23 SK

untere Molaren
lower molars



Konservierende Behandlung
Conserving treatment

Traitement conservant
Tratamiento conservando
Trattamento conservativo



Exkavatoren
Excavators

Excavateurs
Excavadores
Escavatori

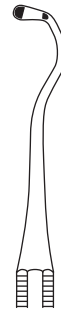

WHITE

	Fig. 5	Fig. 14	Fig. 3
170 mm - 6¾"	tk 71127-05	tk 71127-14	tk 71127-17

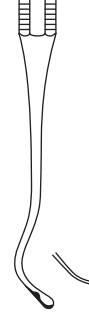
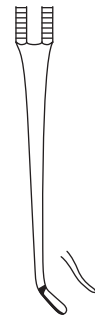

WHITE

	Fig. 18	Fig. 19	Fig. 20
170 mm - 6¾"	tk 71127-18	tk 71127-19	tk 71127-20



Exkavatoren | Excavateurs
Excavators | Excavadores
Escavatori

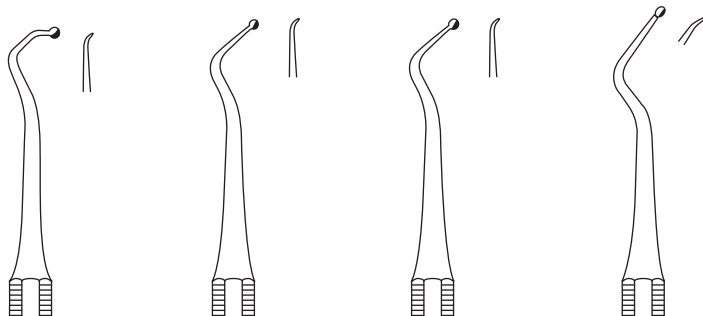

	Fig. 6	Fig. 12	Fig. 14	Fig. 171
170 mm - 6 3/4"	tk 71120-06	tk 71120-12	tk 71120-14	tk 71120-71
	Fig. 7	Fig. 13	Fig. 15	Fig. 172

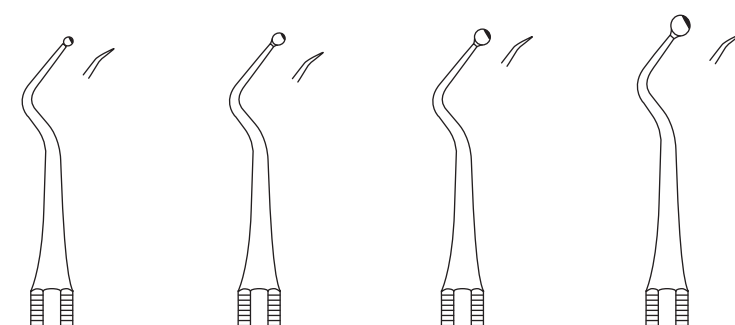
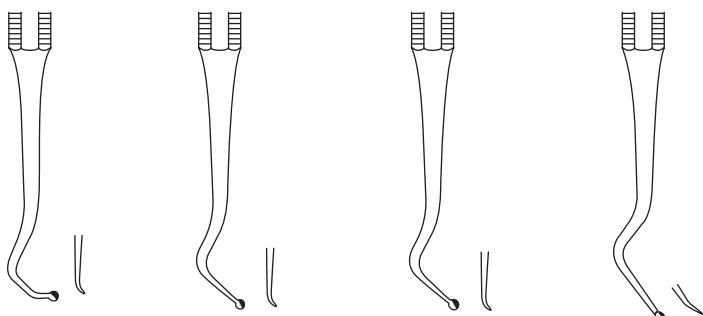
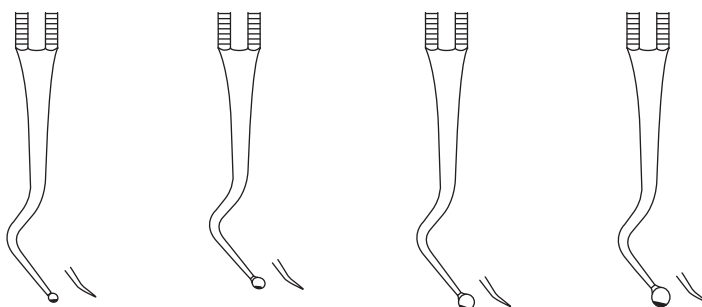

	Fig. 173	Fig. 175	Fig. 177	Fig. 179
170 mm - 6 3/4"	tk 71120-73	tk 71120-75	tk 71120-77	tk 71120-79
	Fig. 174	Fig. 176	Fig. 178	Fig. 180



Amalgampistolen
Amalgam carriers

Portes-amalgame
Portas-amalgama
Porta amalgama



160 mm - 6¼" **tk 71185-01**



210 mm - 8½" **tk 71185-02**



140 mm - 5½" **tk 71187-01**

mit Plastikspitze
with plastic tip



tk 71187-10

Plastikspitze für tk 71187-01
Plastic tip for tk 71187-01

Instrumente für Amalgam, Guttapercha und Zement
Instruments for Amalgam, Gutta-percha and Cement

Instruments pour amalgame, guttapercha et ciment
Instrumentos para amalgama, gutapercha y cemento
 Strumenti per amalgama, guttapercha e cemento



HOLLENBACK

170 mm - 6 3/4"	tk 71197-01	tk 71197-02	tk 71197-03
-----------------	-------------	-------------	-------------

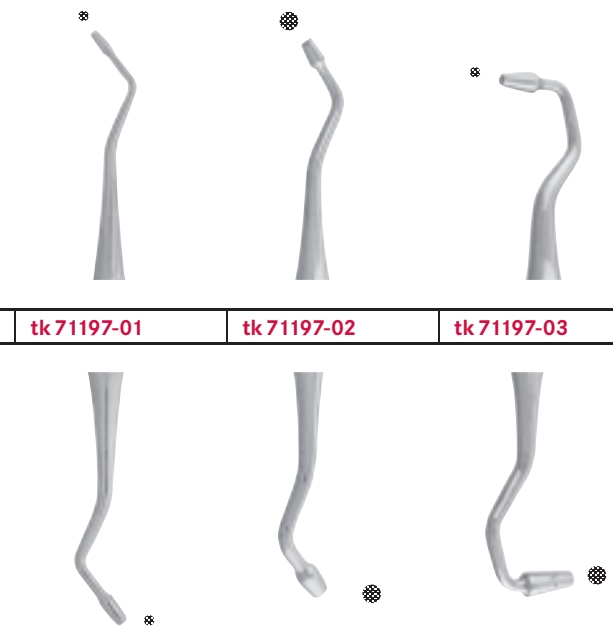

USA

160 mm - 6 1/4"	tk 71199-01	tk 71199-02
-----------------	-------------	-------------

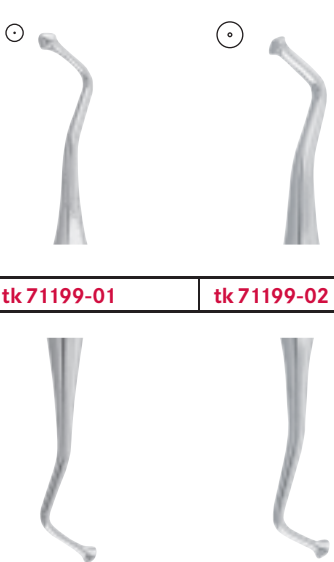

WARD

160 mm - 6 1/4"	tk 71315-02
-----------------	-------------

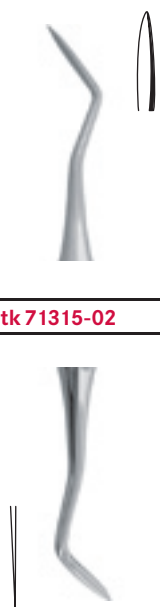

Zementspatel
Cement Spatulas

Spatules à ciment
Espátulas para cemento
Spatole per cemento

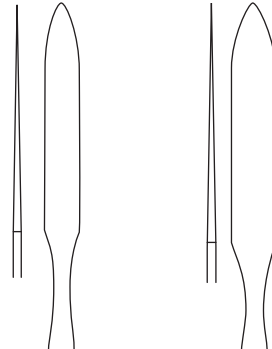
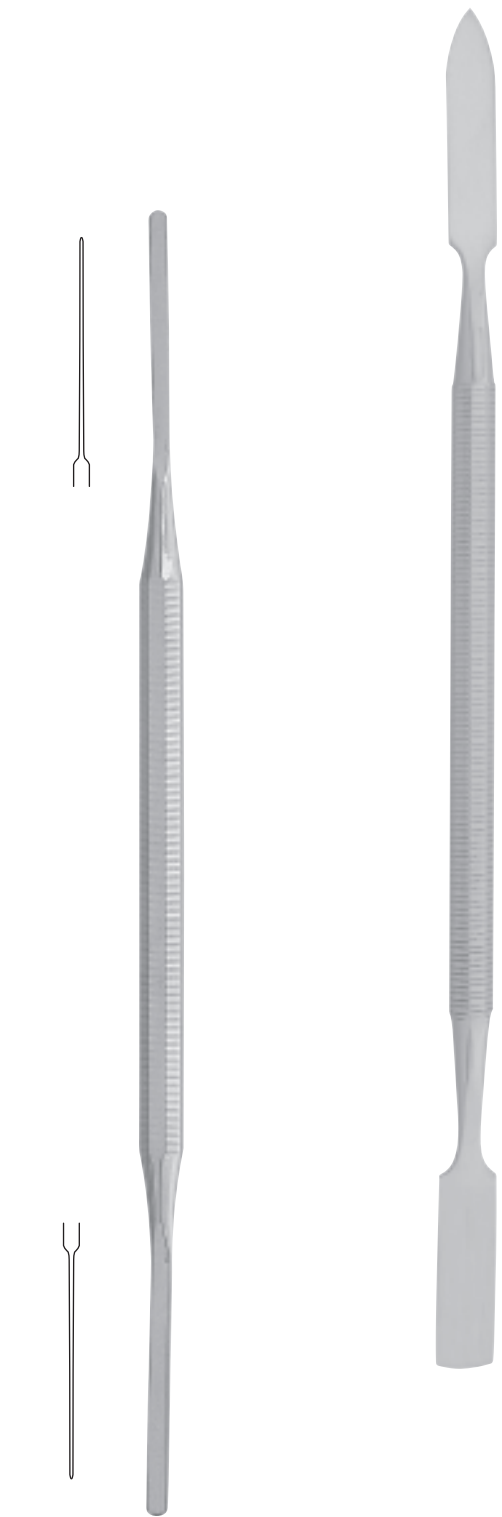

	Fig. 1	Fig. 2
180 mm - 7"	tk 71409-01	tk 71409-02

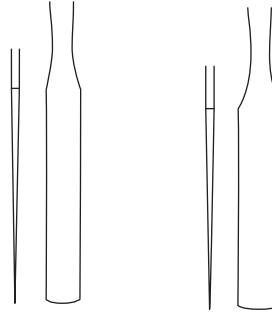
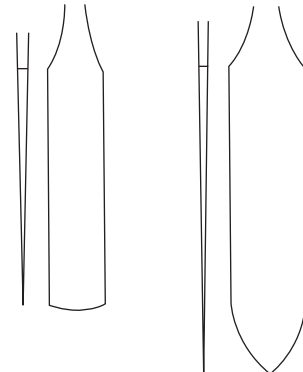

	Fig. 3	Fig. 4
180 mm - 7"	tk 71409-03	tk 71409-04



170 mm - 6 3/4" **tk 71407-00**

Instrumente für plastische Füllungen
Instruments for plastic fillings

Instruments pour plombages plastiques
Instrumentos para obturaciones plásticas
 Strumenti per otturazione

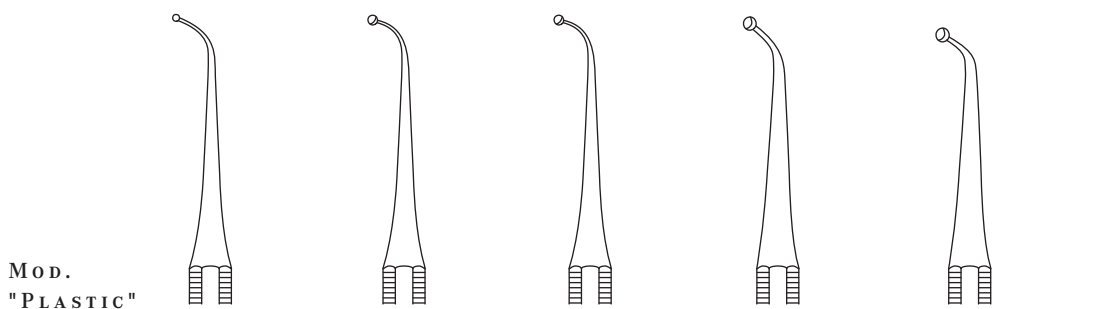

MOD. "PLASTIC"	Fig. 5	Fig. 5 A	Fig. 5 B	Fig. 6	Fig. 7
170 mm - 6 3/4"	tk 71137-05	tk 71137-05 A	tk 71137-05 B	tk 71137-06	tk 71137-07

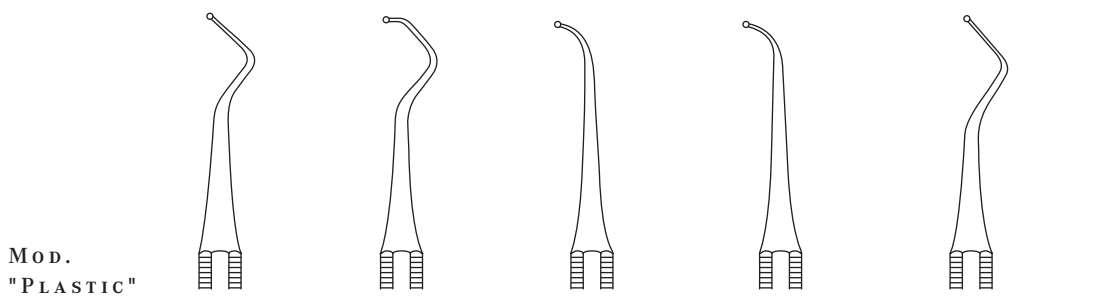
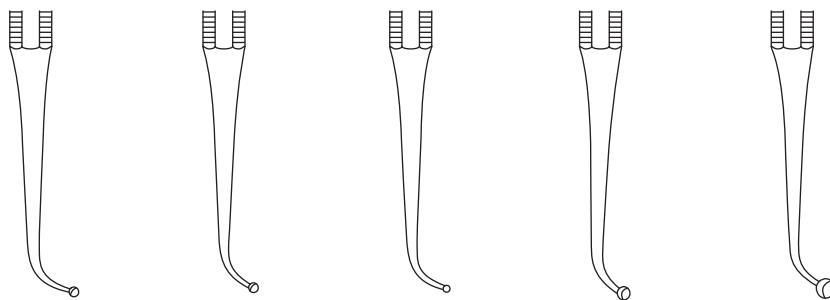

MOD. "PLASTIC"	Fig. 10	Fig. 11	Fig. 12	Fig. 13	Fig. 14
170 mm - 6 3/4"	tk 71137-10	tk 71137-11	tk 71137-12	tk 71137-13	tk 71137-14

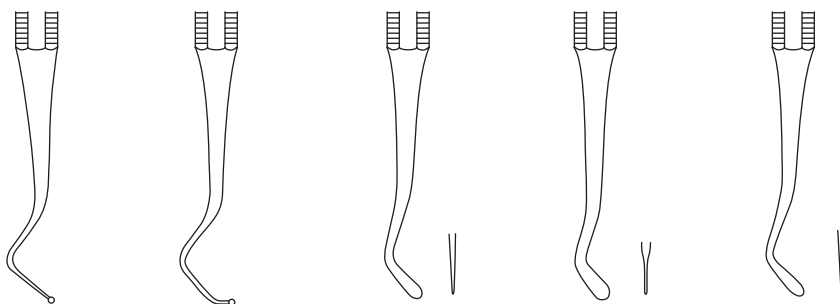

Instrumente für plastische Füllungen
Instruments for plastic fillings

Instrumentos para plombages plásticos
Instrumentos para obturaciones plásticas
Strumenti per otturazione

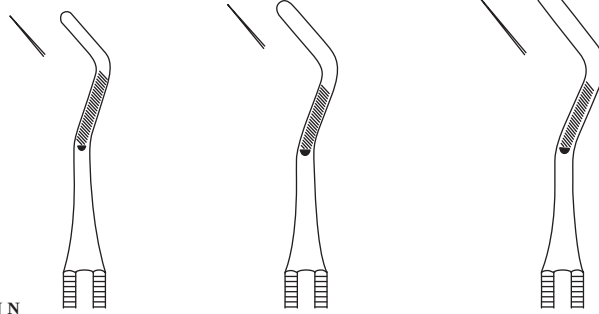

HEIDEMANN

	Fig. 1 / 2/2 mm	Fig. 2 / 2,5/2,5 mm	Fig. 3 / 3/3 mm
170 mm - 6¾"	tk 71138-00	tk 71138-01	tk 71138-02

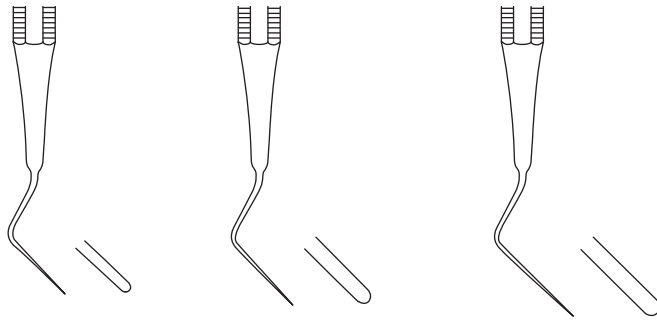

Instrumente für plastische Füllungen
Instruments for plastic fillings

Instruments pour plombages plastiques
Instrumentos para obturaciones plásticas
 Strumenti per otturazione



A S H	Fig. 64	Fig. 65	Fig. 66	Fig. 67
170 mm - 6 3/4"	tk 71141-64	tk 71141-65	tk 71141-66	tk 71141-67

Instrumente für plastische Füllungen
Instruments for plastic fillings

Instrumentos para plombages plásticos
Strumenti per otturazione



	Fig. 5	Fig. 6	Fig. 7
170 mm - 6¾"	tk 71150-05	tk 71150-06	tk 71150-07



	Fig. 146	Fig. 147	Fig. 148
170 mm - 6¾"	tk 71150-46	tk 71150-47	tk 71150-48



Instrumente für plastische Füllungen
Instruments for plastic fillings

Instruments pour plombages plastiques
Instrumentos para obturaciones plásticas
 Strumenti per otturazione

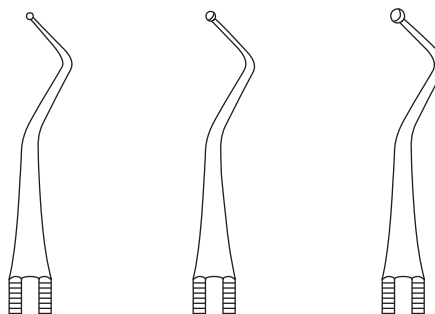

	Fig. 9	Fig. 10	Fig. 11
170 mm - 6 3/4"	tk 71150-09	tk 71150-10	tk 71150-11

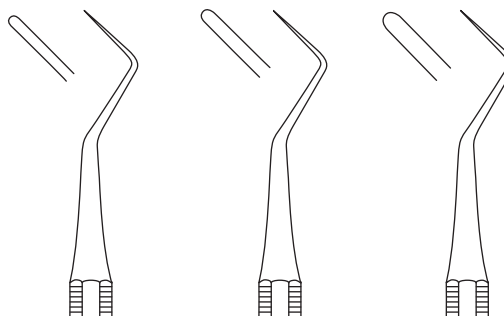
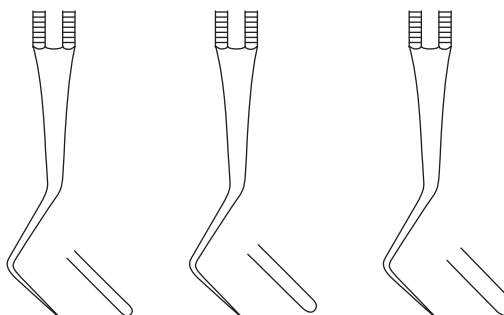
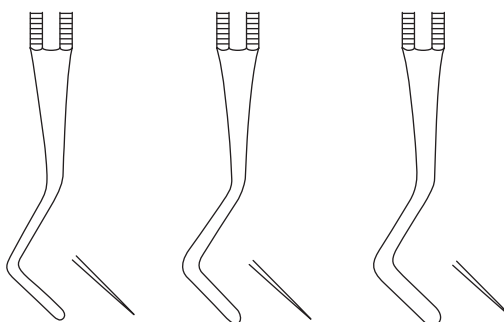

	Fig. 158	Fig. 159	Fig. 160
170 mm - 6 3/4"	tk 71150-58	tk 71150-59	tk 71150-60



Instrumente für plastische Füllungen
Instruments for plastic fillings

Instrumentos para plombages plásticos
Strumenti per otturazione



hohl
hollow



	0.8/1.0 mm	1.2/1.6 mm	2.0/2.5 mm	2.6/3.0 mm
170 mm - 6¾"	tk 71151-01	tk 71151-02	tk 71151-03	tk 71151-04



	1.0/2.0 mm	1.6/2.0 mm	1.6/2.5 mm
170 mm - 6¾"	tk 71151-05	tk 71151-06	tk 71151-07



6

Instrumente für plastische Füllungen
Instruments for plastic fillings

Instruments pour plombages plastiques
Instrumentos para obturaciones plásticas
 Strumenti per otturazione

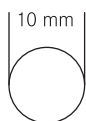

hohl
hollow



BLACK

	1,2 / 1,5 mm	1,5 / 2,5 mm	2,5 / 3,5 mm
170 mm - 6¾"	tk 71152-01	tk 71152-02	tk 71152-03

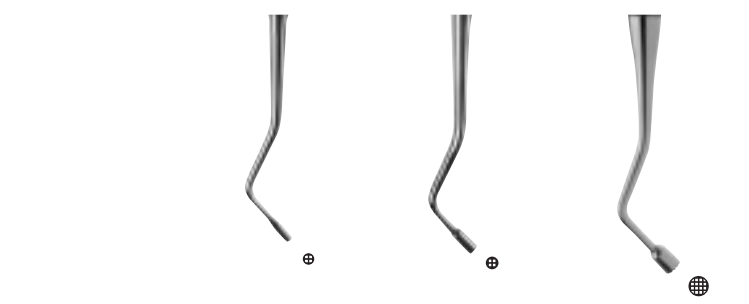

	0.8/1.0 mm	1.2/1.6 mm	1.6/2.0 mm	2.0/2.5 mm
170 mm - 6¾"	tk 71153-01	tk 71153-02	tk 71153-03	tk 71153-04



Instrumente für plastische Füllungen
Instruments for plastic fillings

Instrumentos para plombages plásticos
Strumenti per otturazione



hohl
hollow



	0.8/1.0 mm	1.2/1.6 mm	1.6/2.0 mm	2.0/2.5 mm
170 mm - 6¾"	tk 71154-01	tk 71154-02	tk 71154-03	tk 71154-04

birnenförmig
pear-shaped

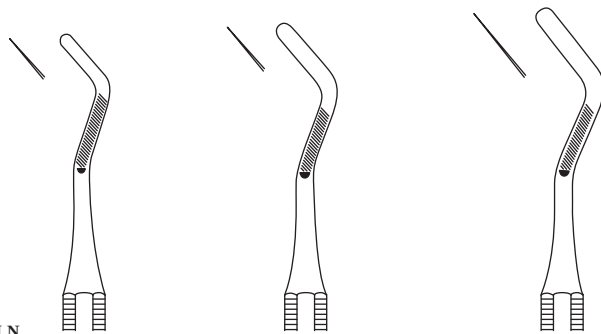
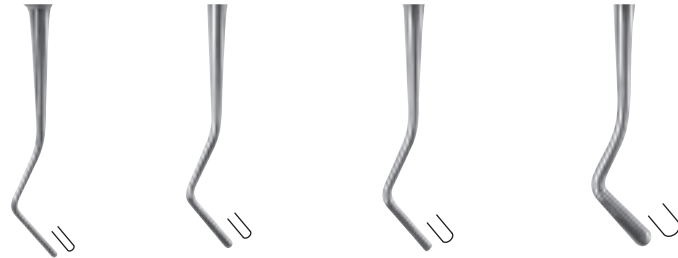

HEIDEMANN

	Fig. 1 / 2/2 mm	Fig. 2 / 2,5/2,5 mm	Fig. 3 / 3/3 mm
170 mm - 6¾"	tk 71138-11	tk 71138-12	tk 71138-13

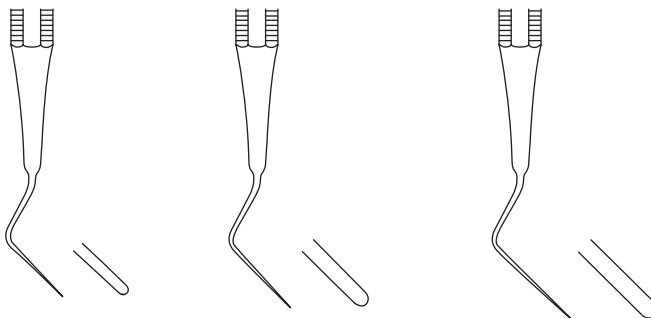

Instrumente für plastische Füllungen
Instruments for plastic fillings

Instruments pour plombages plastiques
Instrumentos para obturaciones plásticas
 Strumenti per otturazione

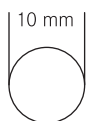

hohl
hollow



HOLLENBECK		
	Fig. 1/2	Fig. 3
170 mm - 6¾"	tk 71160-01	tk 71160-02

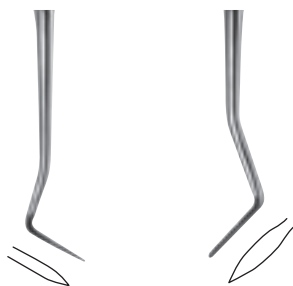

CLEOID-DISCOLD	
	Fig. 1/2
170 mm - 6¾"	tk 71160-05



FRAHM		
	Fig. 1/2	Fig. 2/3
170 mm - 6¾"	tk 71160-03	tk 71160-04

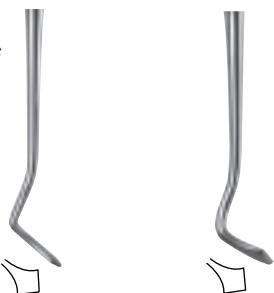

SPRENGEL	
	Fig. 18
170 mm - 6¾"	tk 71160-06



Modellierinstrumente
Modelling instruments

Instrumente für plastische Füllungen
Instruments for plastic fillings

Instrumentes pour plombages plastiques
Instrumentos para obturaciones plásticas
Strumenti per otturazione



hohl
hollow



WESTCOTT

	Fig. 21/13
170 mm - 6¾"	tk71161-01

Polierinstrument
Burnisher

WHITE

	Fig. 26/29
170 mm - 6¾"	tk71161-02

Polierinstrument
Burnisher

BLACK

	Fig. 77/78
170 mm - 6¾"	tk71162-01

Gingivalrandschräger
Gingival margin trimmer

Rubber Dam Instrumente
Rubber Dam Instruments

Instruments Rubber Dam
Instrumentos Rubber Dam
Strumenti Rubber Dam



AINSWORTH

165 mm - 6½" tk 71507-00

Lochzange
Punch



IVORY

150 mm - 6" tk 71501-16

Lochzange
Punch

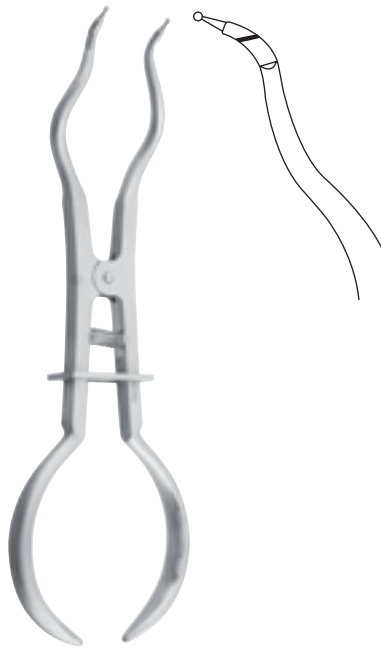

BREWER

170 mm - 6¾" tk 71509-00

Klammerzange
Clamp forceps



IVORY

170 mm - 6¾" tk 71505-16

Klammerzange
Clamp forceps

Matrizenspanner / Rubber Dam Instrumente
Matrix retainers / Rubber Dam Instruments

Porte-matrices / Instruments Rubber Dam
Portamatrices / Instrumentos Rubber Dam
Portamatrici / Strumenti Rubber Dam



TOFFLEMIRE

60 mm - 2½"

tk71586-00



tk 71500-00

Rubber Dam Rahmen
Rubber Dam Frame



Hart-/Weichgewebechirurgie
Hard and soft tissue surgery

Chirurgie pour le tissu dur et moux
Cirugía para el tejido duro y blando
Chirurgia dei tessuti duri e morbidi



Artikulationspinzette / Messinstrumente
Forces for articulation paper / Measuring instruments

Pince pour papier à articuler / Instruments pour mesurer
Pinza para papel de articular / Instrumentos de medición
Pinzette per articolazione / Strumenti di misura



MILLER

155 mm - 6"	tk 70078-15	tk 70079-15
-------------	--------------------	--------------------

Artikulationspapierpinzetten
Articulating paper forceps



125 mm - 5"
tk 72520-00

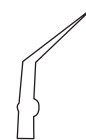

CASTROVIEJO

90 mm - 3½"	0-15 mm	tk 40276-15	-	-
90 mm - 3½"	0-20 mm	tk 40276-20	tk 40275-20	tk 40277-20
90 mm - 3½"	0-40 mm	tk 40276-40	tk 40275-40	tk 40277-40

170 mm - 6¾"
tk 72521-17

Chirurgische Absauger
Suction cannulas

Cannulas d'aspiration
Cánulas de aspiración
Cannule d'aspirazione

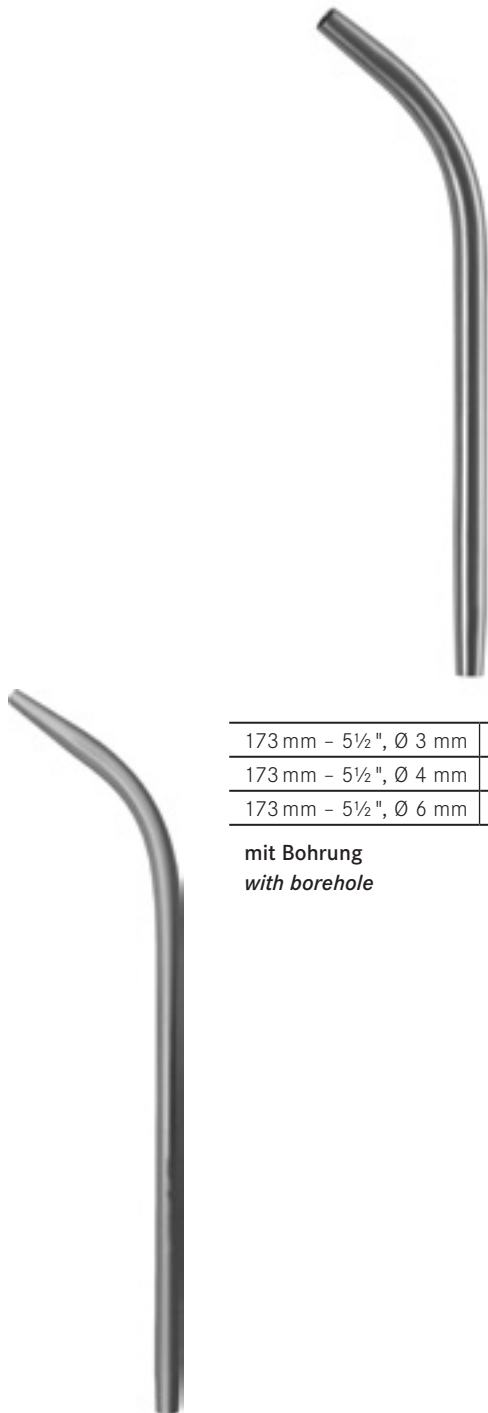

173 mm - 5½", Ø 3 mm	tk 6332-03
173 mm - 5½", Ø 4 mm	tk 6332-04
173 mm - 5½", Ø 6 mm	tk 6332-06

mit Bohrung
with borehole



140 mm - 5½", Ø 3 mm	tk 6331-03
140 mm - 5½", Ø 4 mm	tk 6331-04
140 mm - 5½", Ø 6 mm	tk 6331-06

mit Bohrung
with borehole

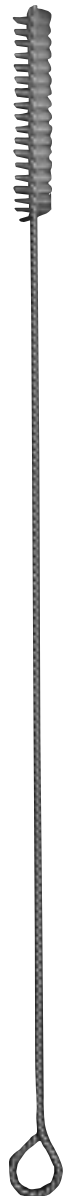

190 mm - 7½", Ø 3 mm	tk 6330-19
185 mm - 7¼", Ø 5 mm	tk 6330-18
140 mm - 5½", Ø 3 mm	tk 6330-14

ohne Bohrung
without borehole

160 mm - 6¼"	tk 6333-16
--------------	-------------------

Reinigungsbürste
Cleaningbrush

Spritzen / Kanülen
Syringes / Cannulas

Seringues / Canules
Jeringas / Cánulas
Siringhe / Canule



10 ml

tk 73150-00

Wasserspritze mit Luer-Lock Kanüle, selbstfüllend
Water syringe with Luer-Lock cannula, self filling



tk 73150-01

Kanüle für Wasserspritze, Luer-Lock Ansatz
Cannula for water syringe, Luer-Lock port

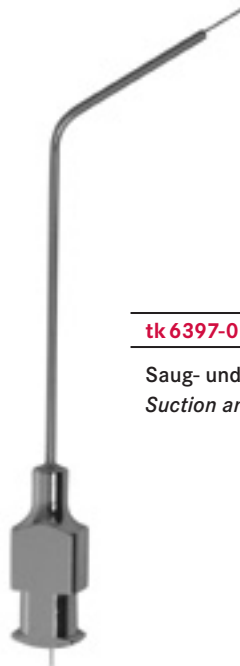

tk 6397-01

Saug- und Spülkanüle, Luer-Lock Ansatz, weiblich, Ø 1,0 mm, 5,0 cm
Suction and irrigation cannula, female Luer-Lock port, female, Ø 1.0 mm, 5.0 cm

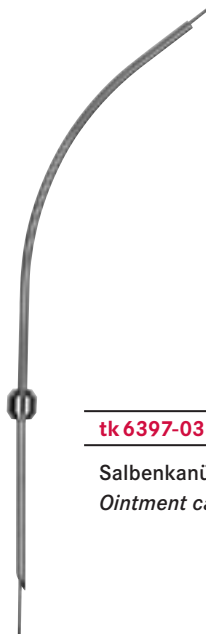

tk 6397-03

Salbenkanüle Ø 1,0 mm
Ointment cannula Ø 1.0 mm



tk 6397-02

Saug- und Spülkanüle, Luer-Lock Ansatz, weiblich und Olive
Suction and irrigation cannula, female Luer-Lock port and olive

Spritzen
Syringes

Seringues
Jeringas
Siringhe



1,8 ml	tk 73115-18
2,2 ml	tk 73115-22

Zylinderampullen-Spritze mit Aspirationshaken,
rostfrei, metrisches Gewinde Ø 6,5 mm
*Cartridge syringe with aspiration device,
stainless steel, metric thread Ø 6.5 mm*



1,8 ml	tk 73116-18
2,2 ml	tk 73116-22

Zylinderampullen-Spritze mit Aspirationshaken,
rostfrei, metrisches Gewinde Ø 6,5 mm
*Cartridge syringe with aspiration device,
stainless steel, metric thread Ø 6.5 mm*



1,8 ml	tk 73117-18
2,2 ml	tk 73117-22

Knickmodell, Zylinderampullen-Spritze mit Aspirationshaken,
rostfrei, metrisches Gewinde Ø 6,5 mm
*Breech loading, Cartridge syringe with aspiration device,
stainless steel, metric thread Ø 6.5 mm*

Mikroklingen Halter – Mikroklingen
Microblade holder – Microblades

Porte micro-lames – Micro-lames
Porta para micro-hojas – Micro-hojas
Porta micro-lame – Micro-lame



Fig. 63	Fig. 64	Fig. 67	Fig. 69
tk 7121-03	tk 7121-04	tk 7121-07	tk 7121-09

Mikroklingen – Packung mit 25 Stück, steril
Micro-blade – package of 25 pieces, sterile

135 mm – 5 $\frac{1}{4}$ "

tk 7120-13

Titan

Titanium



Die abgebildeten Klingen sind steril
The blades on this page are sterile

Skalpelli-Griffe
Scalpel handles

Manches de bistouri
Mangos de bisturí
Manici per bisturi



STANDARD

Fig. 3

tk7110-03

Fig. 3 R

tk7115-03

Fig. 3 RG

tk7116-03

Fig. 7K

tk7110-71

Fig. 7

tk7110-07

Skalpellklingen
Scalpel blades

Lames de bistouris
Hojas de bisturí
Lame per bisturi



Packung mit 100 Stück, steril
Package of 100 pieces, sterile



Fig. 10

tk 7210-10T



Fig. 11

tk 7210-11T



Fig. 12

tk 7210-12T



Fig. 12d

tk 7210-12DT



Fig. 15

tk 7210-15T



Fig. 15c

tk 7210-15CT

doppelschneidend
double cutting edge

passend für Griffe: tk 7110-03, tk 7111-03, tk 7110-07, tk 7110-71, tk 7112-03, tk 7113-03, tk 7115-03, tk 7116-03
for handles: tk 7110-03, tk 7111-03, tk 7110-07, tk 7110-71, tk 7112-03, tk 7113-03, tk 7115-03, tk 7116-03



Die abgebildeten Klingen sind steril
The blades on this page are sterile

Rasierklingenhalter und -brecher
Razor blade holders and breakers

Porte lames et brise lames de rasoir
Pinzas para sujetar y romper hojas de afeitarse
Rompi-lame di rasoio



CASTROVIEJO

130 mm - 5"	tk 7215-13
-------------	-------------------



TROUTMAN-CHRIS



90 mm - 3½"	tk 7220-09	tk 7225-09
-------------	-------------------	-------------------

**tk 7230-10**

Packung mit 10 Stück, nicht steril, brechbar
Package of 10 pieces, not sterile, breakable



Die abgebildeten Klingen werden nicht steril ausgeliefert.
The blades on this page are not sterile.

Zahnfleischmesser
Gumknives

Bistouris à gencives
Bisturías para encías
Coltelli per gengiva



155 mm - 6 "

tk 71070-01

Zahnfleischmesser
Gums knife



150 mm - 5¾ "

tk 71070-02

Zahnfleischmesser
Gums knife

Technische Informationen
Technical information

Information technique
Información técnica
Informazione tecnica

140 mm - 5½"	tk 8198-14	tk 9198-14
140 mm - 5½"	tk 8198-14 SU	tk 9198-14 SU
140 mm - 5½"	tk 8198-14 SUB	tk 9198-14 SUB
140 mm - 5½"	tk 8193-14 TC	tk 9193-14 TC
140 mm - 5½"	tk 8197-14 SU TC	tk 9197-14 SU TC

gerade
straight

droits
recta

rette

gebogen
curved

courbes
curva

curve



standard

Scheren aus rostfreiem Stahl mit Standardschliff für präzises Arbeiten.
Stainless steel scissors with standard cut for precise working.

Ciseaux d'acier inoxydable avec coupe standard pour des travaux précisés.

Tijeras de acero inoxidable con corte standard para un trabajo preciso.

Forbici di acciaio inossidabile con filatura Standard per tagli precisi.



super cut

Messerschliff und Mikroverzahnung für einen feinen minimal traumatisierenden Schnitt.
Knife edges and micro serration for a fine and minimally traumatizing cut.

Aiguisement tranchante et dents micro pour une coupe fine, peu traumatisante.

Hoja de bisturí y dentadura micro para un corte fino, mínimo traumatizante.

Affilatura a scalpello e dentellatura micro per uno taglio fine, minimo traumatizzante.



SUB

super cut

SuperCut Scheren mit schwarzen Griffen.

SuperCut scissors with black handles.

Ciseaux SuperCut avec anneaux noirs

Tijeras SuperCut con anillos negros

Forbici SuperCut con anelli neri

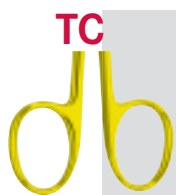

TC
tungsten carbide

Nahtlos aufgeschweisste, korrosionsfreie Hartmetallschneiden.
Seamless welded, corrosion-free tungsten carbide cutting edges.

Plaques en carbure de tungstène, non-corrosives, soudées homogènement dans les lames.

Placas de carburo de tungsteno soldadas homogéneamente y anticorrosiva en las hojas.

Congiunzione omogenea senza cordolo lame saldate al carburo di tungsteno.



SU TC
super cut
tungsten carbide

Nahtlos aufgeschweisste Hartmetallschneide mit Messerschliff und Mikroverzahnung
Tungsten carbide plates, seamlessly welded into the jaws. Knife edges and micro serration.

Plaques en carbure de tungstène, soudées homogènement das les lames. Aiguisement trachante et dents micro.

Placas de carburo de tungsteno soldadas homogéneamente y en las hojas. Hoja de bisturí y dentura micro.

Lame con taglio in tungsteno, senza saldature del morso, con taglio delle lame e dentatura micro.

Chirurgische Scheren
Operating scissors

Ciseaux à chirurgie
Tijeras para cirugía
Forbici per chirurgia



KELLY

160 mm - 6 $\frac{1}{4}$ "	tk 8462-16	tk 8463-16
180 mm - 7"	tk 8462-18	tk 8463-18

Fistel Scheren
Fistula scissors



METZENBAUM

	Fig. 1
145 mm - 5 $\frac{3}{4}$ "	tk 8333-14

Chirurgische Scheren
Operating scissors

Ciseaux à chirurgie
Tijeras para cirugía
Forbici per chirurgia



STANDARD

	Fig. 2
115 mm - 4½"	tk 8024-11

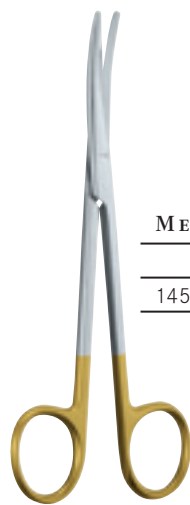

METZENBAUM

	Fig. 1
145 mm - 5¾"	tk 8337-14



Chirurgische Scheren
Operating scissors

Ciseaux à chirurgie
Tijeras para cirugía
Forbici per chirurgia

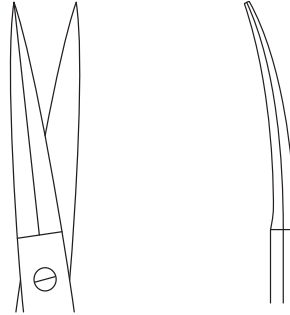

PECK-JOSEF

140 mm - 5½"	tk 8198-14	tk 9198-14
140 mm - 5½"	tk 8198-14 SU	tk 9198-14 SU
140 mm - 5½"	tk 8193-14 TC	tk 9193-14 TC



BROPHY (SULLIVAN)

145 mm - 5¾"	tk 8572-14	tk 8573-14
--------------	-------------------	-------------------

Irisscheren
Iris scissors

Ciseaux à iridectomie
Tijeras para iridectomia
Forbici per iridectomia

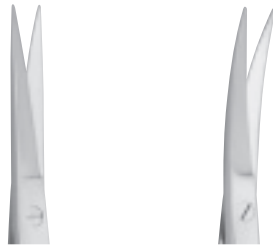

90 mm - 3½"	tk 8642-09	tk 8643-09
115 mm - 4½"	tk 8632-11	tk 8633-11
115 mm - 4½"	tk 8636-11 TC	tk 8637-11 TC



90 mm - 3½"	tk 8652-09	tk 8653-09
100 mm - 4"	tk 8652-10	tk 8653-10
115 mm - 4½"	tk 8652-11	tk 8653-11
100 mm - 4"	tk 8652-10 SU	tk 8653-10 SU

Feine Scheren
Fine scissors

Ciseaux fins
Tijeras finas
Forbici fini



QUINBY

125 mm - 5"



tk 8592-12



NEUMANN

120 mm - 4³/₄"

tk 8597-12

S-förmig gebogen
S curved



LOCKLIN

165 mm - 6¹/₂"

tk 8582-16

gerade, gezahnt
straight, saw edge



tk 8587-16

gebogen, gezahnt
curved, saw edge

Scheren für plastische Operationen
Plastic surgery scissors

Ciseaux pour la chirurgie plastique
Tijeras para cirugía plástica
 Forbici per chirurgia plastica

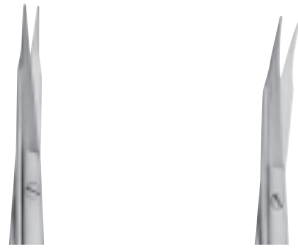

GOLDMAN-FOX

130 mm - 5"	tk 9922-13	tk 9923-13
130 mm - 5"	tk 9922-13 SU	tk 9923-13 SU
130 mm - 5"	tk 9924-13 SU TC	tk 9925-13 SU TC

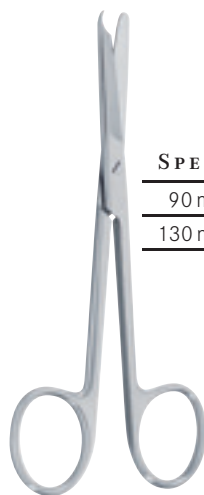

SPENCER

90 mm - 3½"	tk 9532-09
130 mm - 5"	tk 9532-13

Mikroscheren mit Rundgriff
Micro scissors with round handle

Micro ciseaux avec manche ronde
Micro tijeras con mango redondo
 Forbici per micro chirurgia con manico rotondo



VANNAS

	7 mm Ø	7 mm Ø
120 mm - 5"	tk 25612-12	tk 25613-12

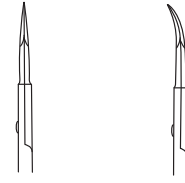

VANNAS

	8 mm Ø	8 mm Ø
150 mm - 6"	tk 25600-15	tk 25601-15

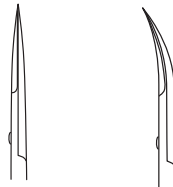

CASTROVIEJO

	8 mm Ø	8 mm Ø
150 mm - 6"	tk 25610-15	tk 25611-15

Mikroscheren | Micro ciseaux
 Micro scissors | Micro tijeras
 Micro forbici



NOYES



	Fig. 1
120 mm - 4 3/4"	tk 9222-01

gerade
 straight

spitz - spitz
 sharp - sharp

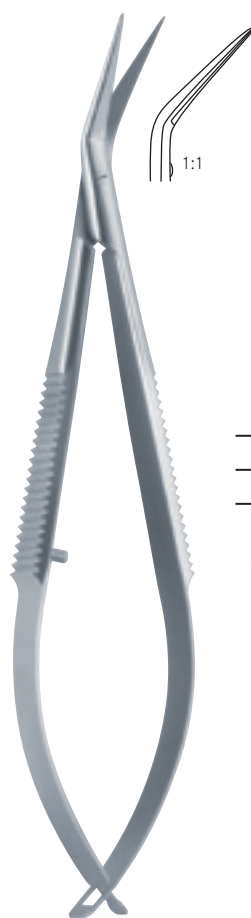

NOYES



	Fig. 1
120 mm - 4 3/4"	tk 9223-01

abgewinkelt
 angulated

spitz - spitz
 sharp - sharp



WESTCOTT



115 mm - 4 1/2"	tk 9262-11	tk 9263-11
-----------------	-------------------	-------------------

Chirurgische Scheren
Operating scissors

Ciseaux à chirurgie
Tijeras para cirugía
Forbici per chirurgia



DEAN

170 cm - 6³/₄" **tk 8852-17**

gebogen
curved



CROWN SCISSORS

100 mm - 4" **tk 9620-10**



UNIVERSAL

120 mm - 4³/₄"

tk 9629-12 TC

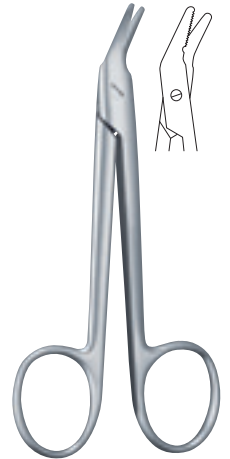

UNIVERSAL

120 mm - 4³/₄"

tk 9622-12

gezahnt
saw edge



120 mm - 4³/₄" **tk 9230-12**

gebogen
curved



115 mm - 4¹/₂"

tk 9432-11
gerade
straight



tk 9434-11
gebogen
curved



tk 9436-11

kniegebogen
angular

Kronenscheren
Crownsissors

Ciseaux pour couronnes
Tijeras para coronas
Forbici per corone



90 mm - 3½"	tk 9617-09	tk 9618-09
110 mm - 4¾"	tk 9617-11	tk 9618-11

gerade
straight

gebogen
curved

LISTER

90 mm - 3½"	tk 9672-09
110 mm - 4¾"	tk 9672-11
140 mm - 5½"	tk 9672-14
180 mm - 7"	tk 9672-18
200 mm - 8"	tk 9672-20



BEEBEE

100 mm - 4"	tk 9582-10	tk 9592-10	tk 9602-10	tk 9612-10
120 mm - 4¾"	tk 9582-12	tk 9592-12	tk 9602-12	tk 9612-12

gerade
straight

stumpf - stumpf
blunt - blunt

spitz - spitz
sharp - sharp

stumpf - stumpf, gezahnt
blunt - blunt, saw edge

spitz - spitz, gezahnt
sharp - sharp, saw edge

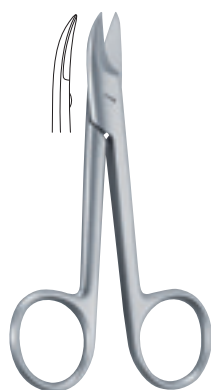

BEEBEE

100 mm - 4"	tk 9583-10	tk 9593-10	tk 9603-10	tk 9613-10
120 mm - 4¾"	tk 9583-12	tk 9593-12	tk 9603-12	tk 9613-12

gebogen
curved

stumpf - stumpf
blunt - blunt

spitz - spitz
sharp - sharp

stumpf - stumpf, gezahnt
blunt - blunt, saw edge

spitz - spitz, gezahnt
sharp - sharp, saw edge



Anatomische Pinzetten
Dressing forceps

Pinces à dissection
Pinzas de disección
Pinzette anatomiche



STILLE

150 mm - 6"	tk 10200-15
180 mm - 7"	tk 10200-18
200 mm - 8"	tk 10200-20



SEMKEN

125 mm - 5"	tk 10300-12
150 mm - 6"	tk 10300-15



CUSHING

175 mm - 7"	tk 10400-17	tk 10401-17
-------------	--------------------	--------------------

Anatomische Pinzetten - Chirurgische Pinzetten
Dressing forceps - Dissecting forceps

Pinces à dissection - Pinces à dissection à griffes
Pinzas de disección - Pinzas de disección con dientes
 Pinze per dissezione - Pinze per dissezione con denti



ADSON

120 mm - 4 3/4"	tk 10500-12
150 mm - 6"	tk 10500-15

120 mm - 4 3/4"	tk 10502-12 TC
150 mm - 6"	tk 10502-15 TC



MICRO-ADSON

120 mm - 4 3/4"	tk 10503-12
150 mm - 6"	tk 10503-15



ADSON-GRAEFE

120 mm - 4 3/4"	tk 11212-12
-----------------	--------------------



ADSON BROWN

120 mm - 4 3/4"	tk 11210-12
120 mm - 4 3/4"	tk 10508-12 TC

Anatomische Pinzetten - Chirurgische Pinzetten
Dressing forceps - Dissecting forceps

Pinces à dissection - Pinces à dissection à griffes
Pinzas de disección - Pinzas de disección con dientes
 Pinze per dissezione - Pinze per dissezione con denti



ADSON

120 mm - 4 ³ / ₄ "	tk 11200-12	tk 11204-12
150 mm - 6 "	tk 11200-15	
120 mm - 4 ³ / ₄ "	tk 10504-12 TC	
150 mm - 6 "	tk 10504-15 TC	

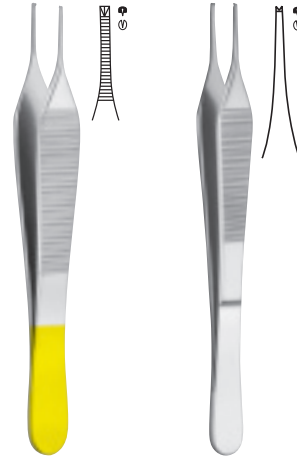

MICRO-ADSON

tk 11202-12	tk 11206-12
tk 11202-15	tk 11206-15
tk 10506-12 TC	
tk 10506-15 TC	



ADSON

120 mm - 4 ³ / ₄ "
tk 11206-13
mit Fadenplatte 1 mm with tying platform 1 mm



ULTRA-MICRO-ADSON
 (BRAKA)

120 mm - 4 ³ / ₄ "
tk 11206-12B
mit Fadenplatte 1 mm with tying platform 1 mm

Anatomische Pinzetten - Chirurgische Pinzetten
Dressing forceps - Dissecting forceps

Pinces à dissection - Pinces à dissection à griffes
Pinzas de disección - Pinzas de disección con dientes
 Pinze per dissezione - Pinze per dissezione con denti



GRAEFE

105 mm - 4 1/4"	tk 11700-10	tk 11701-10	tk 11703-10	tk 11730-10	tk 11731-10	tk 11733-10
-----------------	-------------	-------------	-------------	-------------	-------------	-------------

Chirurgische Pinzetten
Dissecting forceps

Pinces à dissection à griffes
Pinzas de disección con dientes
Pinze per dissezione con denti



SEMKEN

125 mm - 5"	tk 11300-12
150 mm - 6"	tk 11300-15



160 mm - 6¼"	tk 70079-16
--------------	--------------------



CUSHING

175 mm - 7"	tk 10402-17 TC
-------------	-----------------------

Mikro-Pinzetten
Micro forceps

Pinces micro
Micro pinzas
Micro pinze



	x = 0.3 mm	x = 0.5 mm
150 mm - 6"	tk 25686-30	
180 mm - 7"		tk 25686-35

mit Fadenplatte
with tying platform



	x = 0.3 mm	x = 0.5 mm
150 mm - 6"	tk 25687-30	
180 mm - 7"		tk 25687-35

mit Fadenplatte
with tying platform

Atraumatische Pinzetten
Atraumatic tissue forceps

Pinces atraumatiques
Pinzas de disección atraumáticas
Pinze per dissezione atraumatiche

ATRAUMTK

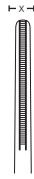

DE BAKEY

	x = 1.5 mm	x = 2.0 mm
120 mm - 4 ³ / ₄ "	tk 11960-12	
145 mm - 5 ³ / ₄ "	tk 11960-14	tk 11964-14
160 mm - 6 ¹ / ₄ "	tk 11960-16	tk 11964-16



DE BAKEY-GERALD

150 mm - 6"	tk 10327-15
180 mm - 7"	tk 10327-18



DE BAKEY BAYONET

180 mm - 7"	tk 10328-18
200 mm - 8"	tk 10328-20

Arterienklemmen | Pincas hémostatiques
 Haemostatic forceps | Pinzas hemostáticas
 Pinze emostatiche



HARTMANN			
100 mm - 4"	tk 12000-10	tk 12001-10	



HALSTED-MOSQUITO				
125 mm - 5"	tk 12010-12	tk 12011-12	tk 12012-12	tk 12013-12
140 mm - 5½"	tk 12010-14	tk 12011-14	tk 12012-14	tk 12013-14
			1x2	1x2
125 mm - 5"	tk 12110-12	tk 12111-12	tk 12112-12	tk 12113-12
Titan <i>Titanium</i>			1x2	1x2



MICRO-MOSQUITO				
100 mm - 4"	tk 12020-10	tk 12021-10	tk 12022-10	tk 12023-10
120 mm - 4¾"	tk 12020-12	tk 12021-12	tk 12022-12	tk 12023-12

Arterienklemmen
Haemostatic forceps

Pinces hémostatiques
Pinzas hemostáticas
Pinze emostatiche

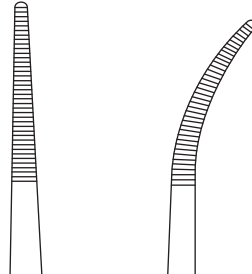

KELLY

140 mm - 5 1/2"	tk 12040-14	tk 12041-14
-----------------	--------------------	--------------------

KELLY-RANKIN

160 mm - 6 1/4"	tk 12040-16	tk 12041-16
-----------------	--------------------	--------------------

KELLY

140 mm - 5 1/2"	tk 12140-14	tk 12141-14
-----------------	--------------------	--------------------

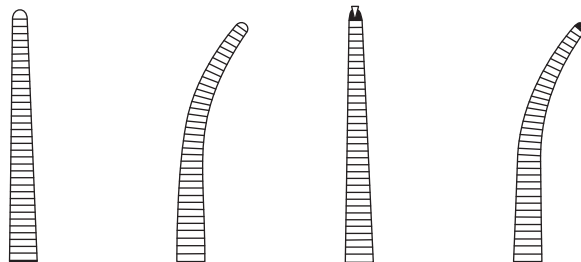

CRILE

140 mm - 5 1/2"	tk 12050-14	tk 12051-14	tk 12052-14	tk 12053-14
			1x2	1x2

CRILE-RANKIN

160 mm - 6 1/4"	tk 12050-16	tk 12051-16	tk 12054-16	tk 12055-16
			1x2	1x2

CRILE

140 mm - 5 1/2"	tk 12250-14	tk 12251-14
-----------------	--------------------	--------------------



Arterienklemmen
Haemostatic forceps

Pinces hémostatiques
Pinzas hemostáticas
Pinze emostatiche

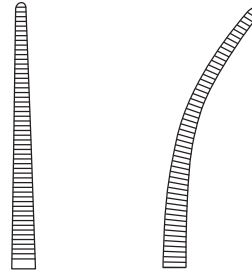

P E A N

130 mm - 5"	tk 12058-13	tk 12059-13
140 mm - 5½"	tk 12058-14	tk 12059-14
160 mm - 6¼"	tk 12058-16	tk 12059-16

graziles Modell
delicate pattern

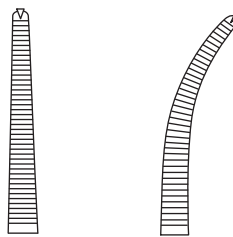

K O C H E R

130 mm - 5"	tk 12078-13	tk 12079-13
140 mm - 5½"	tk 12078-14	tk 12079-14
160 mm - 6¼"	tk 12078-16	tk 12079-16

graziles Modell
delicate pattern

1x2

1x2

Gewebefasszangen
Tissue holding forceps

Pinces de tissu
Pinzas para tejidos
Pinze per tessuti



ALLIS-BABY

130 mm - 5"

tk 28100-14

4 x 5



ALLIS

150 mm - 6"

tk 28140-15

tk 28160-15

4 x 5

5 x 6



ALLIS-ADAIR

155 mm - 6'

tk 28167-15

10 x 11



WILLIAMS

160 mm - 6 1/4"

tk 28192-16

Tuchklemmen
Towel forceps

Pinces à champs
Pinzas de campo
Pinze fissateli

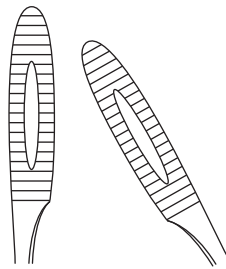
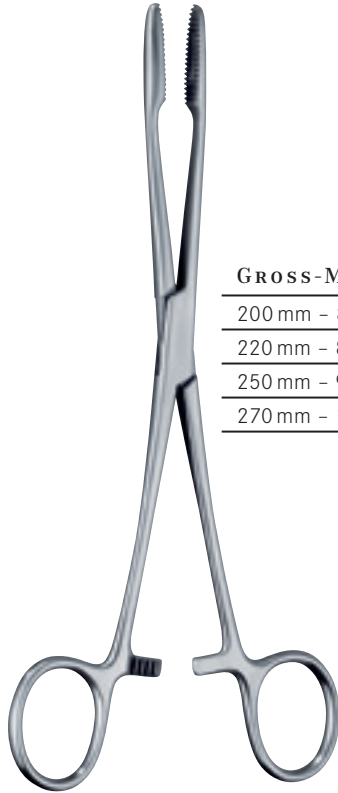

GROSS-MAIER

200 mm - 8"	tk 15110-20	tk 15111-20
220 mm - 8 ³ / ₄ "	tk 15110-22	tk 15111-22
250 mm - 9 ³ / ₄ "	tk 15100-25	tk 15101-25
270 mm - 10 ³ / ₄ "	tk 15100-27	tk 15101-27



BACKHAUS

90 mm - 3 ¹ / ₂ "	tk 12805-09
110 mm - 4 ¹ / ₄ "	tk 12805-11
130 mm - 5"	tk 12805-13

Mundsperrer
Mouth gags

Ouvre-bouches
Abrebocas
Apribocca



MOLT

110 mm - 4 $\frac{3}{4}$ "

tk 52131-11

Für Kinder
For children



MOLT

140 mm - 5 $\frac{1}{2}$ "

tk 52131-14

Für Erwachsene
For adults



DENHART

120 mm - 4 $\frac{3}{4}$ "

tk 52141-12



FERGUSSON-ACKLAND

145 mm - 5 $\frac{3}{4}$ "

tk 52142-14



ROSER-KÖNIG

160 mm - 6 $\frac{1}{4}$ "

tk 52149-16

190 mm - 7 $\frac{1}{2}$ "

tk 52149-19

Mundsperrer
Mouth gags

Ouvre-bouches
Abrebocas
Apribocca

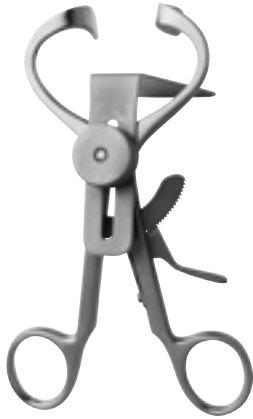

tk 52143-00

1 Paar Schutzhüllen für tk 52143-11 & tk 52143-14
1 pair of protective covers for tk 52143-11 & tk 52143-14

MOLT MOD.

110 mm - 4¼" **tk 52143-11**

mit Zungendrücker
with tongue depressor

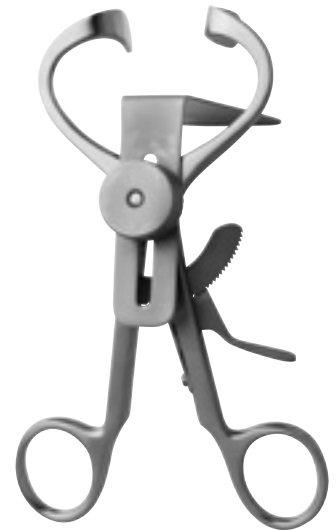

MOLT MOD.

140 mm - 5½" **tk 52143-14**

mit Zungendrücker
with tongue depressor



tk 52144-00

2 Stück Silikoneinlagen für tk 52144-13
2 pcs of silicon inserts for tk 52144-13

DENHART

130 mm - 4¼" **tk 52144-13**

Wundhaken
Retractors

Ecarteurs
Separadores
Divaricatori



160 mm - 6¼"	tk 17021-16	tk 17022-16	tk 17024-16
--------------	--------------------	--------------------	--------------------

flexibel, scharf
flexible, sharp



160 mm - 6¼"	tk 17031-16	tk 17032-16	tk 17034-16
--------------	--------------------	--------------------	--------------------

flexibel, stumpf
flexible, blunt

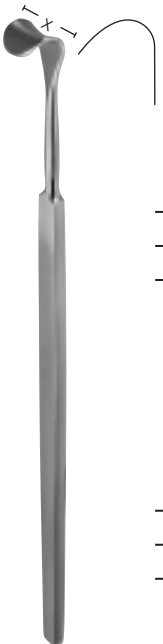

DESMARRES



	x = 8 mm	x = 10 mm	x = 12 mm
160 mm - 6¼"	tk 17038-08	tk 17038-10	tk 17038-12



	x = 14 mm	x = 16 mm	x = 18 mm
160 mm - 6¼"	tk 17038-14	tk 17038-16	tk 17038-18

Wundhaken
Retractors

Ecarteurs
Separadores
Divaricatori



MINI-LANGENBECK

	10 mm x 6 mm	17 mm x 5 mm	20 mm x 6 mm	22 mm x 8 mm
160 mm - 6¼"	tk 17039-10	tk 17039-17	tk 17039-20	tk 17039-22

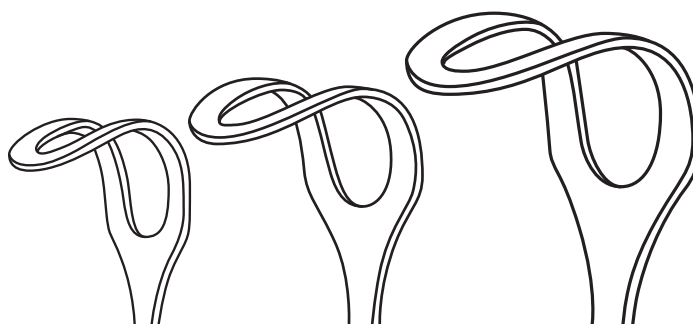

MIDDELDORPF

	14 mm x 17 mm	20 mm x 22 mm	26 mm x 30 mm
	215 mm - 8½"	220 mm - 8¾"	235 mm - 9¼"
	tk 17085-21	tk 17086-22	tk 17087-23

Wundhaken
Retractors

Ecarteurs
Separadores
Divaricatori

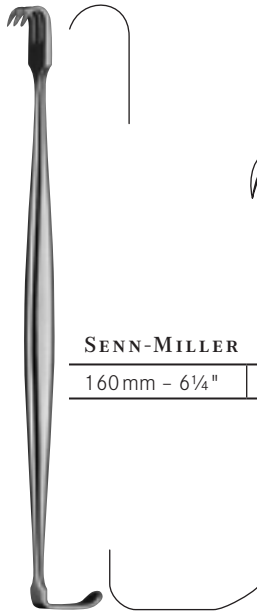

SENN-MILLER

160 mm - 6 1/4"

tk 17080-16

tk 17081-16

scharf
sharp

stumpf
blunt

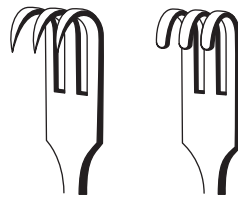

COTTLE

150 mm - 6"

tk 17085-15



13 mm x 5 mm

KILNER

155 mm - 6"

tk 17082-15

Wundhaken
Retractors

Ecarteurs
Separadores
Divaricatori



SENN-GREEN

	20 mm x 6 mm	10 mm x 6 mm
150 mm - 6"	tk 17083-01	tk 17083-02



1:1

8 mm x 4 mm

RAGNELL-
DAVIS

140 mm - 5½"

tk 17084-14

15 mm x 5,5 mm

Wundhaken
Retractors

Ecarteurs
Separadores
Divaricatori



LANGENBECK



	Fig. 1	Fig. 2	Fig. 3
	30 mm x 11 mm	30 mm x 14 mm	30 mm x 16 mm
210 mm - 8 1/4"	tk 17112-01	tk 17112-02	tk 17112-03



	Fig. 4	Fig. 5
	40 mm x 11 mm	50 mm x 11 mm
210 mm - 8 1/4"	tk 17112-04	tk 17112-05



KOCHER-LANGENBECK
(OBWEGESER)

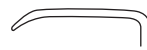

	25 mm x 7 mm	35 mm x 8 mm	35 mm x 11 mm	35 mm x 15 mm
215 mm - 8 1/2"	tk 17114-01	tk 17114-02	tk 17114-03	tk 17114-04



	42 mm x 10 mm	55 mm x 12 mm	70 mm x 14 mm
215 mm - 8 1/2"	tk 17114-05	tk 17114-06	tk 17114-07

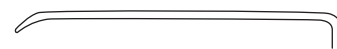
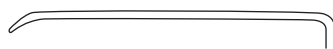

	80 mm x 12 mm	80 mm x 16 mm
215 mm - 8 1/2"	tk 17114-08	tk 17114-09

Weichteilhaken für die Kieferchirurgie
Soft tissue retractors for maxillo-facial surgery

Ecarteurs pour la chirurgie maxillo-faciale
Ganchos para cirugía maxilofacial
 Uncini per chirurgia massilofaciale



OBWEGESER

	13 mm x 42 mm	12 mm x 60 mm
220 mm - 8 $\frac{3}{4}$ "	tk 52715-01	tk 52715-02



	16 mm x 80 mm
220 mm - 8 $\frac{3}{4}$ "	tk 52715-03

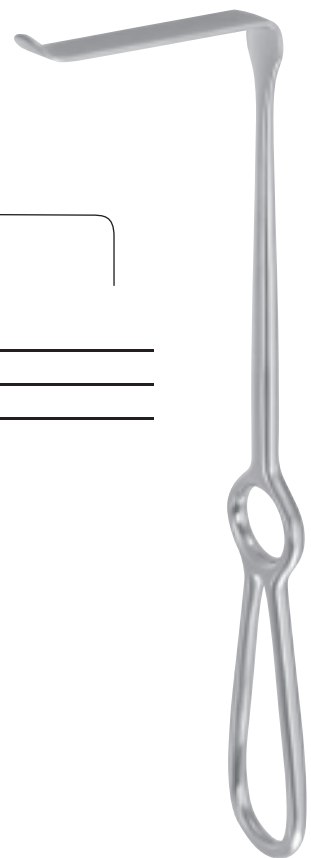

Weichteilhaken für die Kieferchirurgie
Soft tissue retractors for maxillo-facial surgery

Ecarteurs pour la chirurgie maxillo-faciale
Ganchos para cirugía maxilofacial
Uncini per chirurgia massilofaciale



OBWEGESER

	44 mm x 9,5 mm	70 mm x 11,5 mm
220 mm - 8 ³ / ₄ "	tk 52717-22	tk 52719-22

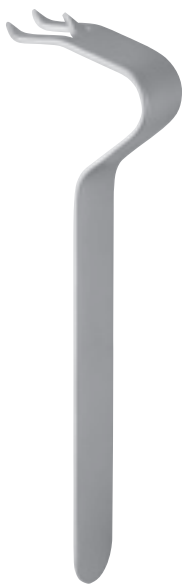

OBWEGESER

155 mm - 6"
tk 52723-16



OBWEGESER

	8 mm	10 mm
160 mm - 6 ¹ / ₄ "	tk 52725-08	tk 52725-10

biegsam
malleable

Wundhaken | Ecarteurs
 Retractors | Separadores
 Divaricatori

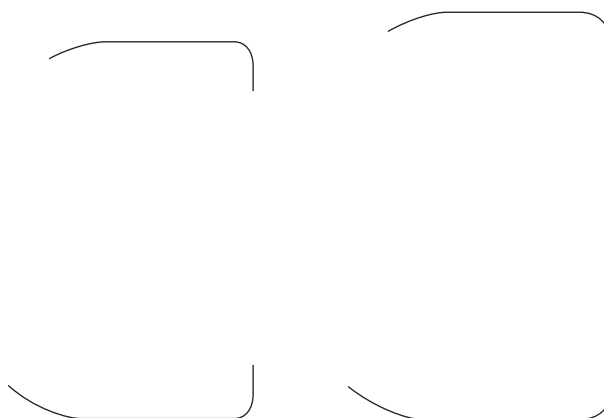

FARABEUF

120 mm - 4¾"	Fig. 1	Fig. 2
	26 mm x 10 mm	30 mm x 10 mm
	30 mm x 12 mm	34 mm x 12 mm
tk 17311-12	x	x

Satz
 Set



FARABEUF

150 mm - 6"	Fig. 1	Fig. 2
	23 mm x 16 mm	27 mm x 16 mm
	26 mm x 16 mm	30 mm x 16 mm
tk 17312-15	x	x

Satz
 Set

Wangenhalter / Zungenzangen / Zungendrucker
 Cheek retractors / Tongue holding forceps / Tongue depressors

Ecarteur des joues / Pincés tire langue / Abaisse-langues
 Separador de mejillas / Pinzas tiralingua / Baja lenguas
 Divaricatori per guancia / Pinze tiralingua / Abbassalingua



WIEDER

150 mm - 6"	tk 5479-01	
140 mm - 5½"		tk 5479-02

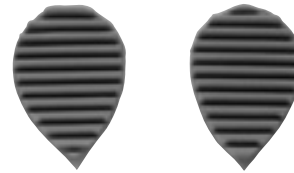
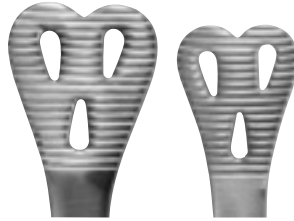

tk 5410-90

1 Paar Ersatz Gummi-Einsätze
 1 Pair rubber-inserts



YOUNG

170 mm - 6¾"	tk 5410-17
--------------	-------------------

STERNBERG

120 mm - 4¾"	tk 5471-12
140 mm - 5½"	tk 5471-14
160 mm - 6¼"	tk 5471-16



CAEWOOD-MINNESOTA

155 mm - 6"	tk 5494-15
-------------	-------------------

Zungenspatel | Abaisse-langues
Tongue depressors | *Espatulas bucales*
 Abbassalingua



EMOS

170 mm - 6¾" | **tk 5496-17**



165 mm - 6½" | **tk 5497-16**



200 mm - 8" / 10 mm	tk 5488-10
200 mm - 8" / 15 mm	tk 5488-15
200 mm - 8" / 20 mm	tk 5488-20



BRUENINGS

190 mm - 7½" | **tk 5487-19**



KROENIG

150 mm - 6" | **tk 5485-15**

Nadelhalter mit Hartmetalleinsätzen im Maulbereich Needle holders with tungsten-carbide inserts in the jaws

Porte-aiguilles avec des inserts de carbure de tungstène dans les mors
Porte-agujas con insertos de carburo tungsteno en las bocas
Port'aghi con inserti in carburo di tungsteno



Alle Nadelhalter mit „tucar“ Hartmetalleinsätzen bieten einen sicheren, festen Halt der Nadel und verhindern deren Verdrehen. Zur Kennzeichnung sind alle Hartmetall-Nadelhalter an den Ringgriffen bzw. den Branchen vergoldet.

All the needle holders with “tucar” tungsten-carbide inserts offer a safe and secure grip of the needle and prevent the twisting of the same. Needle holders with tungsten-carbide inserts are identified by gold-plated rings or handles.

Tous les porte-aiguilles avec des inserts «tucar» de carbure de tungstène garantissent que les aiguilles sont tenues sûres et fortes et qu'elles ne peuvent pas se tordre. Les portes aiguilles avec des inserts de tungstène de carbure peuvent être reconnus à leurs bagues ou manches dorées.

Todas las porta-agujas “tucar” con los insertos de carburo tungsteno aseguran la sujeción firme y seguro de las agujas que evita la torsión de las cuales. Porta-agujas con insertos de carburo de tungsteno se reconocen por los anillos o mangos dorados.

Tutti i port'aghi con inserti in carburo di tungsteno “tucar” (tungsten-carbide) assicurano una presa dell'ago sicura e forte, che previene la torsione dall'ago stesso. I port'aghi con inserto in carburo di tungsteno sono riconoscibili per la doratura del manico o degli anelli.

0.5 mm

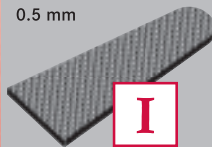

I

Normal für Nadeln und Nahtmaterial bis Stärke 4-0
Regular for use with needles and sutures up to size 4-0

Normale pour aiguilles et matériel à suture jusqu'à l'épaisseur de 4-0
Normal para agujas y material de suturar hasta el espesor de 4-0
Normale per aghi e materiale per sutura fino ad uno spessore di 4-0

0.4 mm

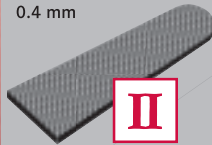

II

Fein für feine Nadeln und Nahtmaterial Stärke 5-0 + 6-0
Fine for delicate needles and sutures sizes 5-0 + 6-0

Fino pour aiguilles fines et matériel à suture à l'épaisseur 5-0 + 6-0
Fine para agujas finas y material de suturar espesores 5-0 + 6-0
Fine per aghi fini e materiale per sutura con spessore 5-0 + 6-0

0.3 mm

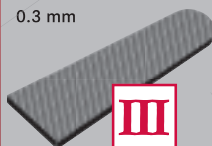

III

Extrafein für Mikro-Nadeln und Nahtmaterial Stärke 7-0 bis 10-0
Extrafine for use with micro-needles and sutures size 7-0 and 10-0

Extrafino pour micro-aiguilles et matériel à suture à l'épaisseur 7-0 à 10-0
Extrafine para micro-agujas y material de suturas espesor 7-0 y 10-0
Extrafine per micro-aghi e materiale per sutura 7-0 e 10-0

Glatt für feine Nadeln und Nahtmaterial Stärke 7-0 bis 12-0
Smooth for delicate needles and sutures sizes 7-0 and 12-0

Liso pour aiguilles fines et matériel à suture à l'épaisseur 7-0 à 12-0
Lisse para agujas finas y material de suturas espesor 7-0 y 12-0
Liscia per aghi fini e materiale per sutura 7-0 e 12-0

IV

Nadelhalter
Needle holders

Porte-aiguilles
Porta-agujas
Porta aghi



DERF
125 mm - 5"
tk 20308-12

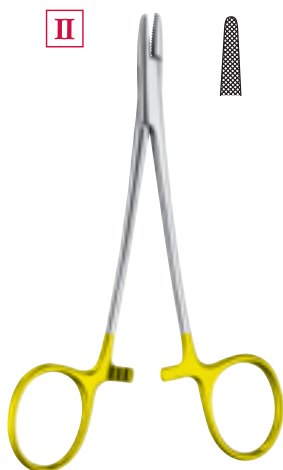

DERF
120 mm - 4¾" tk 20508-12 TC



CRILE-MURRAY
150 mm - 6"
tk 20001-15



DERF
120 mm - 4¾" tk 20008-12
ein Maul gefenstert
one fenestrated jaw



CRILE-WOOD
150 mm - 6" tk 20502-15 TC
180 mm - 7" tk 20502-18 TC
200 mm - 8" tk 20502-20 TC



CRILE-WOOD
150 mm - 6" tk 20002-15
180 mm - 7" tk 20002-18
200 mm - 8" tk 20002-20

Nadelhalter
Needle holders

Porte-aiguilles
Porta-agujas
Porta aghi



HEGAR-BAUMGARTNER

140 mm - 5 3/4" **tk 20503-14 TC**



HEGAR-BAUMGARTNER

140 mm - 5 3/4" **tk 20003-14**



WEBSTER

130 mm - 5" **tk 20509-13 TC**

glatt
smooth



WEBSTER

130 mm - 5" **tk 20009-13**

glatt
smooth



BABY-CRILE-WOOD

150 mm - 6"

tk 20504-15 TC



MATHIEU-OLSEN

140 mm - 5 1/2" **tk 20516-14 TC**

170 mm - 6 3/4" **tk 20516-17 TC**

200 mm - 8" **tk 20516-20 TC**

Nadelhalter
Needle holders
Porte-aiguilles
Porta-agujas
Porta aghi



IV



II



HALSEY

130 mm - 5"	tk 20510-13 TC	tk 20511-13 TC
	glatt smooth	gerieft serrated



MATHIEU-OLSEN

140 mm - 5½"	tk 20106-14
170 mm - 6¾"	tk 20106-17
200 mm - 8"	tk 20106-20



HALSEY

130 mm - 5"	tk 20010-13	tk 20011-13
	glatt smooth	gerieft serrated

II



OLSEN-HEGAR

120 mm - 4¾"	tk 20536-12 TC
140 mm - 5½"	tk 20536-14 TC
170 mm - 6¾"	tk 20536-17 TC
190 mm - 7½"	tk 20536-19 TC

OLSEN-HEGAR

120 mm - 4¾"	tk 20036-12
140 mm - 5½"	tk 20036-14
170 mm - 6¾"	tk 20036-17
190 mm - 7½"	tk 20036-19



Nadelhalter
Needle holders

Porte-aiguilles
Porta-agujas
Porta aghi

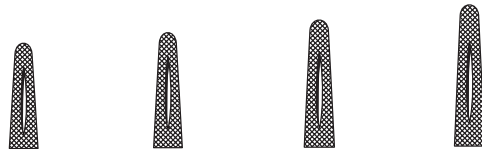

MAYO-HEGAR

140mm - 5½"	160mm - 6¼"	180mm - 7"	200mm - 8"
tk 20012-14	tk 20012-16	tk 20012-18	tk 20012-20

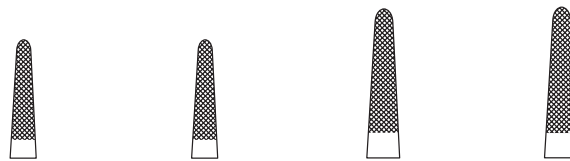

MAYO-HEGAR

140 mm - 5½"	160 mm - 6¼"	180 mm - 7"	200 mm - 8"
tk 20512-14 TC	tk 20512-16 TC	tk 20512-18 TC	tk 20512-20 TC

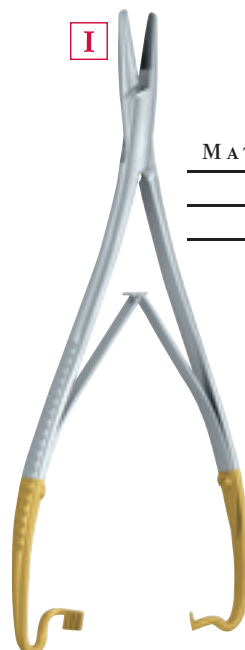

MATHIEU

170 mm - 6¾"	200 mm - 8"
tk 20610-17 tucar	tk 20610-20 tucar

Nadelhalter
Needle holders

Porte-aiguilles
Porta-agujas
Porta aghi

II

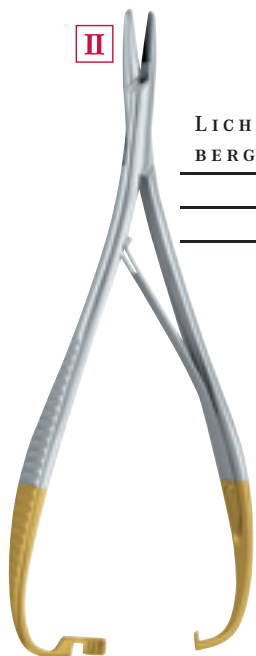

LICHTEN-
BERG



170 mm - 6 3/4"	200 mm - 8"
tk 20615-17 tucar	tk 20615-20 tucar

II



GILLIES

160 mm - 6 1/4"	tk 20535-16 TC
-----------------	-----------------------

II



HÖSEL



200 mm - 8"
tk 20622-20 tucar

mit langem Hals
with long neck



GILLIES

160 mm - 6 1/4"	tk 20035-16
-----------------	--------------------

Nadelhalter
Needle holders

Porte-aiguilles
Porta-agujas
Porta aghi

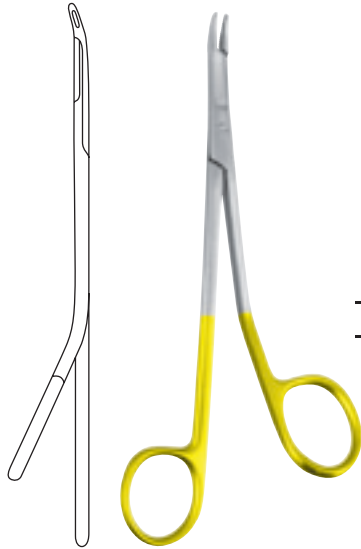

GILLIES

145 mm - 5¾"



tk 20035-14

tk 20535-14 TC



FOSTER-GILLIES

120 mm - 4¾"



tk 20546-12 TC

gerade, gerieft
straight, serrated



tk 20548-12 TC

gerade, glatt
straight, smooth



tk 20547-12 TC

gebogen, gerieft
curved, serrated



tk 20549-12 TC

gebogen, glatt
curved, smooth

Nadelhalter | Porte-aiguilles
Needle holders | Porta-agujas
 Porta aghi

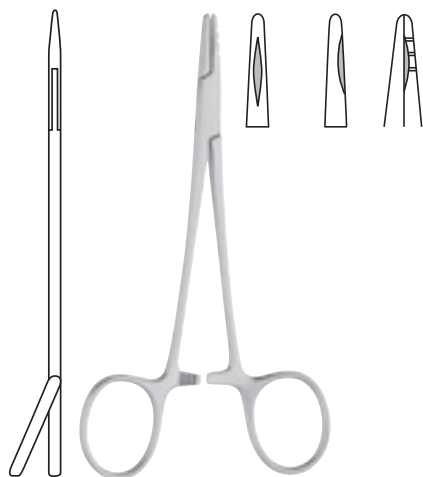

NEIVERT
 125 mm - 5"
tk 20304-13



KILNER
 135 mm - 5 1/4"
tk 20533-13 TC



VASCULAR





140 mm - 5 1/2"	180 mm - 7"
tk 20525-14 TC	tk 20525-18 TC

Nadelhalter
Needle holders

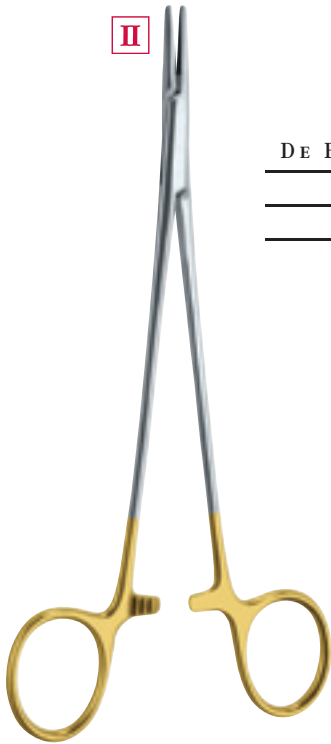
Porte-aiguilles
Porta-agujas
Porta aghi

II



DE BAKEY				
	180 mm - 7"	200 mm - 8"	230 mm - 9"	260 mm - 10¼"
	tk 20522-18 tucar	tk 20522-20 tucar	tk 20522-23 tucar	tk 20522-26 tucar

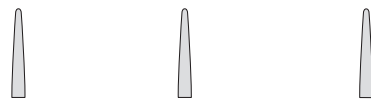

130 mm - 5"	150 mm - 5¾"	170 mm - 6¾"
tk 20570-13	tk 20570-15	tk 20570-17

mit Spezialbeschichtung im Maul
with special coated jaw



Beschichtung mit Hartmetallstaub.

Sicheres Halten der Nadel

Speziell geeignet für feine Nadelhalter, keine Bruchgefahr der Maulspitzen.

Jaws coated with carbide dust.

Secure fixing of the needle.

Suitable for delicate needle-holders, no risk of breakage of the jaws

Nadelhalter | Porte-aiguilles
Needle holders | Porta-agujas
Porta aghi



CASTROVIEJO-
JACOBSON



140 mm - 5½"		tk 20710-14D TC
150 mm - 6"	tk 20704-15D TC	tk 20710-15D TC
180 mm - 7"	tk 20704-18D TC	tk 20710-18D TC
210 mm - 8¼"	tk 20704-21D TC	tk 20710-21D TC

gerieftes Maul serrated jaw	gerade, ohne Sperre straight, without ratchet	gerade, mit Sperre straight, with ratchet
--------------------------------	--	--



140 mm - 5½"		tk 20711-14D TC
150 mm - 6"	tk 20705-15D TC	tk 20711-15D TC
180 mm - 7"	tk 20705-18D TC	tk 20711-18D TC
210 mm - 8¼"	tk 20705-21D TC	tk 20711-21D TC

gerieftes Maul serrated jaw	gebogen, ohne Sperre curved, without ratchet	gebogen, mit Sperre curved, with ratchet
--------------------------------	---	---



CASTROVIEJO-
JACOBSON



140 mm - 5½"		tk 20210-14D
150 mm - 6"	tk 20204-15D	tk 20210-15D
180 mm - 7"	tk 20204-18D	tk 20210-18D
210 mm - 8¼"	tk 20204-21D	tk 20210-21D

gerieftes Maul serrated jaw	gerade, ohne Sperre straight, without ratchet	gerade, mit Sperre straight, with ratchet
--------------------------------	--	--



140 mm - 5½"		tk 20211-14D
150 mm - 6"	tk 20205-15D	tk 20211-15D
180 mm - 7"	tk 20205-18D	tk 20211-18D
210 mm - 8¼"	tk 20205-21D	tk 20211-21D

gerieftes Maul serrated jaw	gebogen, ohne Sperre curved, without ratchet	gebogen, mit Sperre curved, with ratchet
--------------------------------	---	---

Mikronadelhalter mit Rundgriff
Micro needle holders with round handle

Micro porte aiguilles avec manche ronde
Micro porta agujas con mango redondo
 Micro porta aghi con manico rotondo

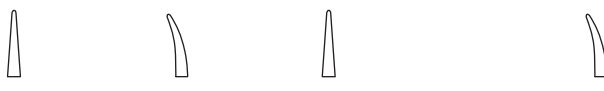

BARRAQUER					
140 mm - 5½"	8 mm Ø	tk 25622-01	tk 25622-02	tk 25622-05	tk 25622-06

ohne Sperre, sehr feines Maul <i>without ratchet, extra delicate jaws</i>	gerade <i>straight</i>	gebogen <i>curved</i>	gerade, diamantiert <i>straight, diamond coated</i>	gebogen, diamantiert <i>curved, diamond coated</i>
--	---------------------------	--------------------------	--	---



140 mm - 5½"	8 mm Ø	tk 25622-03	tk 25622-04	tk 25622-07	tk 25622-08
--------------	--------	--------------------	--------------------	--------------------	--------------------

mit Sperre, sehr feines Maul <i>with ratchet, extra delicate jaws</i>	gerade <i>straight</i>	gebogen <i>curved</i>	gerade, diamantiert <i>straight, diamond coated</i>	gebogen, diamantiert <i>curved, diamond coated</i>
--	---------------------------	--------------------------	--	---



BARRAQUER			
145 mm - 5¾"	tk 20200-14	tk 20201-14	

gerade <i>straight</i>	gebogen <i>curved</i>
---------------------------	--------------------------

Scharfe Doppellöffel
Bone currettes, double-ended

Curettes doubles
Cucharillas de doble extremo
Curette doppia



MARTINI

	Fig. 00	Fig. 0	Fig. 1
	Fig. 0	Fig. 1	Fig. 2
135 mm - 5 1/4"	tk 24485-00	tk 24485-01	tk 24485-12



MARTINI

	Fig. 00	Fig. 0	Fig. 1
	Fig. 00	Fig. 0	Fig. 1
155 mm - 6"	tk 24489-20	tk 24489-10	tk 24489-01



WILLIGER

	Fig. 00	Fig. 0	Fig. 1
	Fig. 0	Fig. 1	Fig. 2
135 mm - 5 1/4"	tk 24487-00	tk 24487-01	tk 24487-12



WILLIGER

	Fig. 00	Fig. 0	Fig. 1
	Fig. 00	Fig. 0	Fig. 1
155 mm - 6"	tk 24490-20	tk 24490-10	tk 24490-01

Scharfe Doppellöffel
Bone curettes, double-ended

Curettes doubles
Cucharillas de doble extremo
Curette doppia

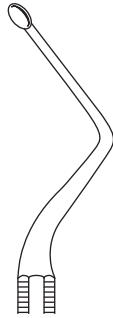

HEMINGWAY

180 mm - 7 1/2"

tk 24480-11

tk 24480-22

tk 24480-33

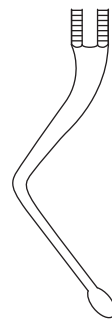
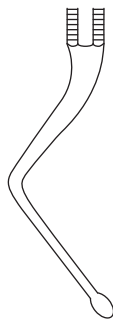

175 mm - 6 3/4"

tk 24482-01

tk 24482-02

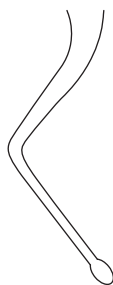

Raspatorien – Elevatorien
Periosteal raspatories – Elevators

Rugines – Elevateurs
Raspatorios – Elevadores
 Periostotomi – Elevatori

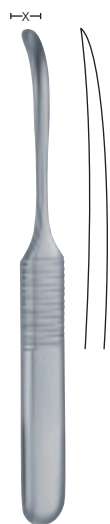

WILLIGER

	x = 5 mm
130 mm – 5"	tk 24525-13



WILLIGER

	160 mm – 6¼"
x = 4 mm	tk 24525-16
x = 6 mm	tk 24526-16



WILLIGER

	x = 5 mm	x = 6.5 mm
160 mm – 6¼"	tk 24532-16	tk 24533-17



ADSON

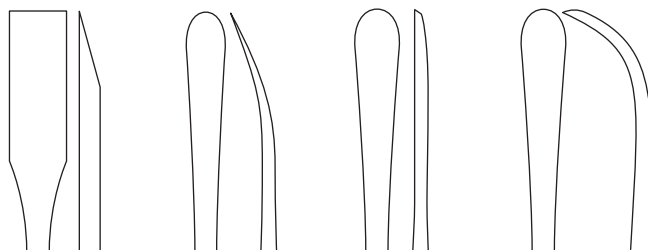

	Fig. 1	Fig. 2	Fig. 3	Fig. 4
170 mm – 6¾"	tk 24535-01	tk 24535-02	tk 24535-03	tk 24535-04

Raspatorien für die Kieferchirurgie
Periosteal elevators for maxillo-facial surgery

Rugines – Décolleurs pour la chirurgie maxillo-faciale
Periostótomos para la cirugía maxilofacial
Raspatori per chirurgia massilofaciale



SEBILEAU	
	x = 5 mm
175 mm - 7"	tk 24544-17

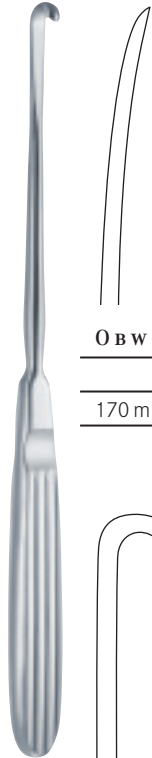

OBWEGESER

	6 mm	7 mm	9 mm	11 mm
170 mm - 6¾"	tk 52730-06	tk 52730-07	tk 52730-09	tk 52730-11

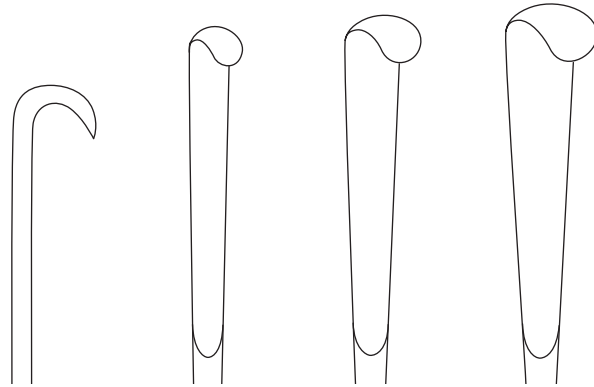

	5 mm	8 mm	9 mm
200 mm - 8"	tk 52731-05	tk 52731-08	tk 52731-09



OBWEGESER-FREER

210 mm - 8¼"	tk 52738-21
--------------	--------------------



OBWEGESER-FREER

210 mm - 8¼"	tk 52740-21
--------------	--------------------

Raspatorien für die Kieferchirurgie
Periosteal elevators for maxillo-facial surgery

Rugines – Décolleurs pour la chirurgie maxillo-faciale
Periostótomos para la cirugía maxilofacial
 Raspatori per chirurgia massilofaciale



	Fig. A2	Fig. 16
x =	4.0 mm	7.0 mm
174 mm - 6¾"	tk 52733-02	tk 52733-03
y =	3.5 mm	4.0 mm



MOLT

	Fig. 9	Fig. 3
x =	4.0 mm	3.0 mm
174 mm - 6¾"	tk 52733-04	tk 52733-05
y =	7.5 mm	4.5 mm



HIRSCHFELD

	Fig. 20
x =	4.5 mm
174 mm - 6¾"	tk 52733-06
y =	3.5 mm



GLICKMANN

x =	4.0 mm
174 mm - 6¾"	tk 52733-01
y =	3.5 mm



FREER

	Fig. 1
x =	5.0 mm
174 mm - 6¾"	tk 52733-07
y =	5.0 mm



PRICHARD

	Fig. 35
x =	10.5 mm
174 mm - 6¾"	tk 52733-08
y =	4.5 mm



Raspatorien für die Kieferchirurgie
Periosteal elevators for maxillo-facial surgery

Rugines – Décolleurs pour la chirurgie maxillo-faciale
Periostótomos para la cirugía maxilofacial
 Raspatori per chirurgia massilofaciale



KHOURY

x =	8.0 mm
174 mm - 6¾"	tk 52733-09
y =	5.0 mm



	Fig. A1
x =	8.0 mm
z =	5.0 mm
174 mm - 6¾"	tk 52733-10
y =	3.5 mm



MOLT

x =	11.0 mm
174 mm - 6¾"	tk 52733-11
z =	3.0 mm
y =	8.0 mm



WACHTEL

x =	2.5 mm	3.0 mm
174 mm - 6¾"	tk 52733-12	tk 52733-13
y =	1.5 mm	2.0 mm



BUSER

	Fig. 1	Fig. 2
x =	5.0 mm	3.0 mm
174 mm - 6¾"	tk 52733-14	tk 52733-15
y =	4.0 mm	3.0 mm



Knochenküretten
Bones cures

Curettes à os
Curetas para huesos
Curette per osso

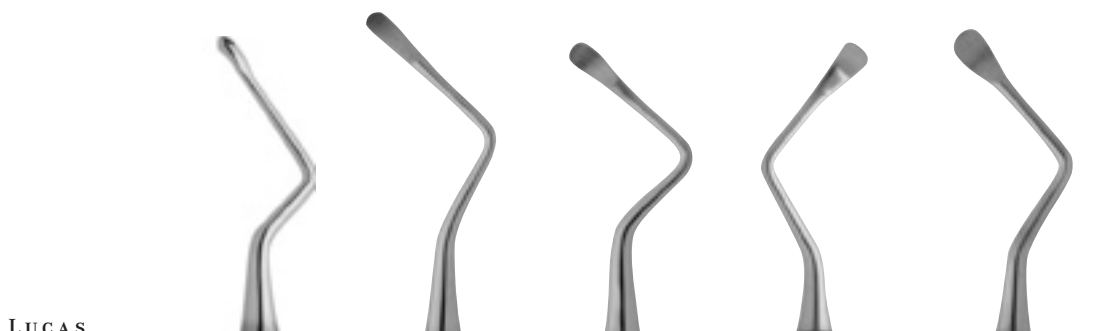

LUCAS

	Fig. 0R-0L	Fig. 1R-1L	Fig. 2R-2L	Fig. 3R-3L	Fig. 4R-4L
174 mm - 6 3/4 "	tk 71286-00	tk 71286-01	tk 71286-02	tk 71286-03	tk 71286-04



MILLER-COLBURN

	Fig. 9	Fig. 10	Fig. 11	Fig. 12
174 mm - 6 3/4 "	tk 71286-09	tk 71286-10	tk 71286-11	tk 71286-12

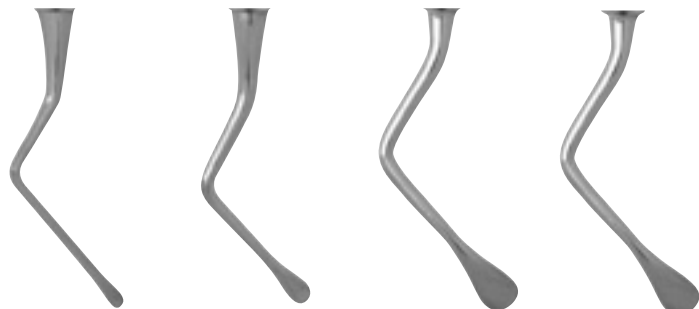

Knochenkürretten
Bones curettes

Curettes à os
Curetas para huesos
Curette per osso



MILLER-COLBURN

	Fig. 13
174 mm - 6¾"	tk 71286-13



MOLT

	Fig. 2/4
174 mm - 6¾"	tk 71286-24

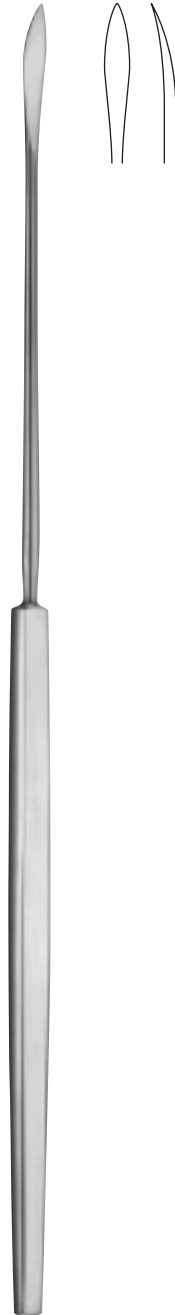

175 mm - 7"	tk 24546-17
-------------	--------------------

extrem leicht
extremely light

Knochenfeilen
Bone files

Limes à os
Lima de hueso
Lime di ossa



MILLER-COLBURN

	Fig. 1x	Fig. 2x
174 mm - 6¾"	tk 71923-01	tk 71923-02

MILLER

	Fig. 52
174 mm - 6¾"	tk 71923-03

Hämmer
Mallets

Maillets
Martillos
Martelli



190 mm - 7½"

250 mm Ø - 205 g

tk 24056-19

Massiver Stahl, mit Kunststoffbacken
Solid steel, with plastic faces

tk 24056-90

Ersatzbacken, 1 Paar
Spare faces, 1 pair

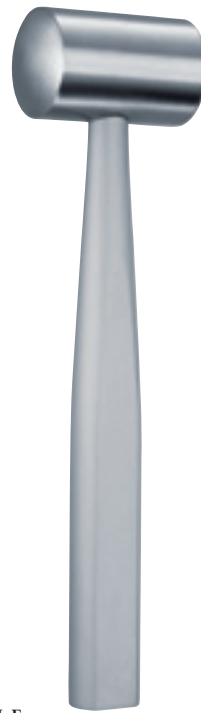

COTTLE

185 mm - 7¼"

30 mm Ø - 240 g

tk 50581-19

1 Seite flach / 1 Seite convex
1 side flat / 1 side convex

Hämmer
Mallets

Maillets
Martillos
Martelli

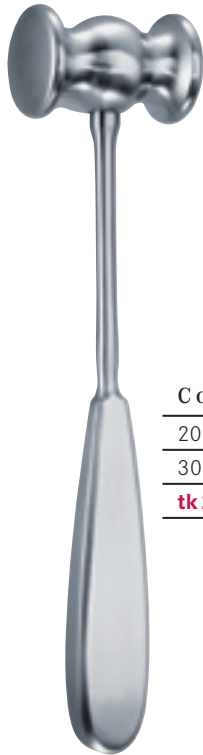

COLLIN

200 mm - 8"

30 mm Ø - 220 g

tk 24051-20



MEAD

170 mm - 6³/₄"

26 mm Ø - 320 g

tk 24050-17

Stahl massiv, mit Kunststoffbacken
Steel solid, with plastic faces

tk 24050-90

Ersatzbacken, 1 Paar
Spare faces, 1 pair

Knochenmeißel
Bone chisels and gouges

Ciseaux-burins, gouges
Cinceles, gubias
Scalpelli, sgorbi

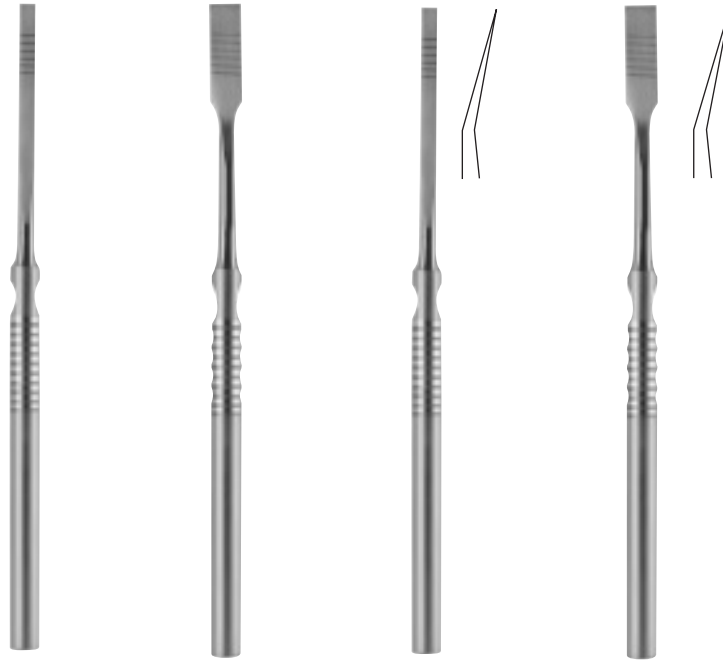

	4 mm	8 mm	4 mm	8 mm
170 mm - 6¾"	tk 24077-02	tk 24077-03	tk 24077-04	tk 24077-05



170 mm - 6¾"	tk 72500-00
--------------	--------------------

Handgriff
Handle

Knochenmeißel
Bone chisels and gouges

Ciseaux-burins, gouges
Cinceles, gubias
Scalpelli, sgorbi

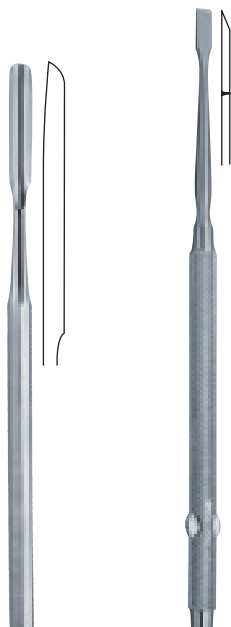

FREER

	150 mm - 6"	160 mm - 6¼"
6 mm	tk 24251-15	
4 mm		tk 24252-16

Hohlmeißel
Gouge

Flachmeißel
Chisel



KRAMER-NEVINS

	5 mm
170 mm - 6¾"	tk 24077-01



**MANNERFELT
MODIF.**

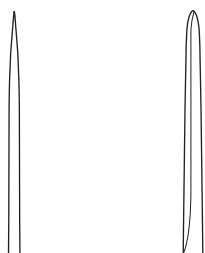

	155 mm - 6"	155 mm - 6"
3 mm		tk 24254-03
4 mm	tk 24253-04	
6 mm	tk 24253-06	
8 mm	tk 24253-08	

Osteotome
Osteotomes

Hohlmeißel
Gouge

Knochenmeißel
Bone chisels and gouges

Ciseaux-burins, gouges
Cinceles, gubias
ScalPELLI, sgorbi



SHEEHAN

	2 mm	4 mm	6 mm	8 mm
160 mm - 6¼"	tk 24295-02	tk 24295-04	tk 24295-06	tk 24295-08

	10 mm	12 mm	15 mm	18 mm
	tk 24295-10	tk 24295-12	tk 24295-15	tk 24295-18



MINI-LAMBOTTE

	125 mm - 5"	170 mm - 6¾"
3 mm	tk 24094-03	tk 24095-03
4 mm	tk 24094-04	tk 24095-04
6 mm	tk 24094-06	tk 24095-06
8 mm	tk 24094-08	tk 24095-08
10 mm	tk 24094-10	tk 24095-10
12 mm	tk 24094-12	tk 24095-12
15 mm	tk 24094-15	tk 24095-15

Hohlmeißelzangen | Pincés gougés
Bone rongeurs | *Pinzas gubias*
 Pinze sgorbie

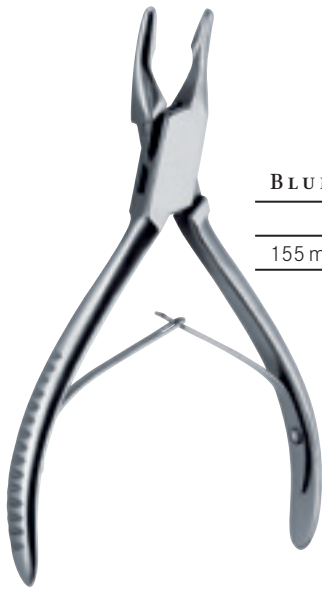

BLUMENTHAL

	Fig. 1	Fig. 2	Fig. 3
155 mm - 6"	tk 24606-01	tk 24606-02	tk 24606-03

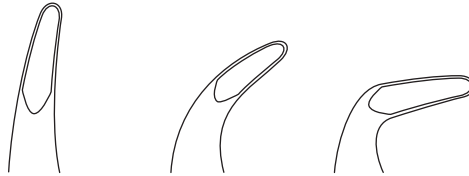

FRIEDMANN
 140 mm - 5½"
 tk 24605-14



MINI-
 FRIEDMANN
 120 mm - 4¾"
 tk 24605-12



Hohlmeißelzangen
Bone rongeurs

Pinces gouges
Pinzas gubias
Pinze sgorbie



MEAD
165 mm - 6½"
tk 24631-16



CLEVELAND
170 mm - 6¾"
tk 24637-17



CLEVELAND
140 mm - 5½"
tk 24635-14



LUER		
	Fig. 1	Fig. 2
150 mm - 6"	tk 24601-15	tk 24602-15

Hohlmeißelzangen / Knochensplitterzangen
Bone rongeurs / Bone cutting forceps

Pinces gouges / Pinces coupantes à os
Pinzas gubias / Pinzas cortantes para huesos
 Pinze sgorbie / Cesioie per ossa

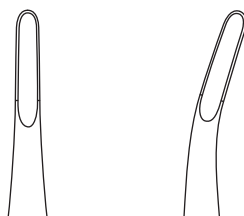

BÖHLER

150 mm - 6"	tk 24613-00	tk 24613-02
-------------	--------------------	--------------------

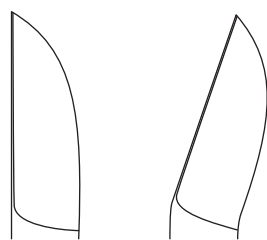

LISTON

140 mm - 5½"	tk 24650-14	tk 24651-14
170 mm - 6¾"	tk 24650-17	tk 24651-17

gerade
straight

gebogen
curved

Zahnfleischklappenstanzen
Punches for gingival valvular

Pinces emporte-pièces à gencives
Punzones para encía
Pinze taglianti per gengive

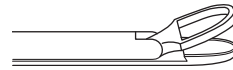

TOMATI

x = 120 mm - 4 3/4" **tk 51173-12**

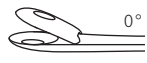

0°



45°

**WEIL-
BLAKESLEY**



	Fig. 1	Fig. 2	Fig. 3	Fig. 4	Fig. 5
	a = 3.0 mm	a = 3.5 mm	a = 4.5 mm	a = 5.0 mm	a = 5.5 mm
x = 120 mm - 4 3/4"	tk 51155-01	tk 51155-02	tk 51155-03	tk 51155-04	tk 51155-05

x = 120 mm - 4 3/4"	tk 51158-01	tk 51158-02	tk 51158-03	tk 51158-04	
---------------------	--------------------	--------------------	--------------------	--------------------	--



0°



45°

	Fig. 1	Fig. 2	Fig. 3	Fig. 4	Fig. 5
	a = 3.0 mm	a = 3.5 mm	a = 4.5 mm	a = 5.0 mm	a = 5.5 mm
x = 180 mm - 7"	tk 51160-01	tk 51160-02	tk 51160-03	tk 51160-04	tk 51160-05

x = 180 mm - 7"	tk 51161-01	tk 51161-02	tk 51161-03	tk 51161-04	tk 51161-05
-----------------	--------------------	--------------------	--------------------	--------------------	--------------------

Sinus-lift-Instrumente
Sinus-lift instruments

Instruments Sinus-lift
Instrumentos Sinus-lift
Strumenti Sinus-lift

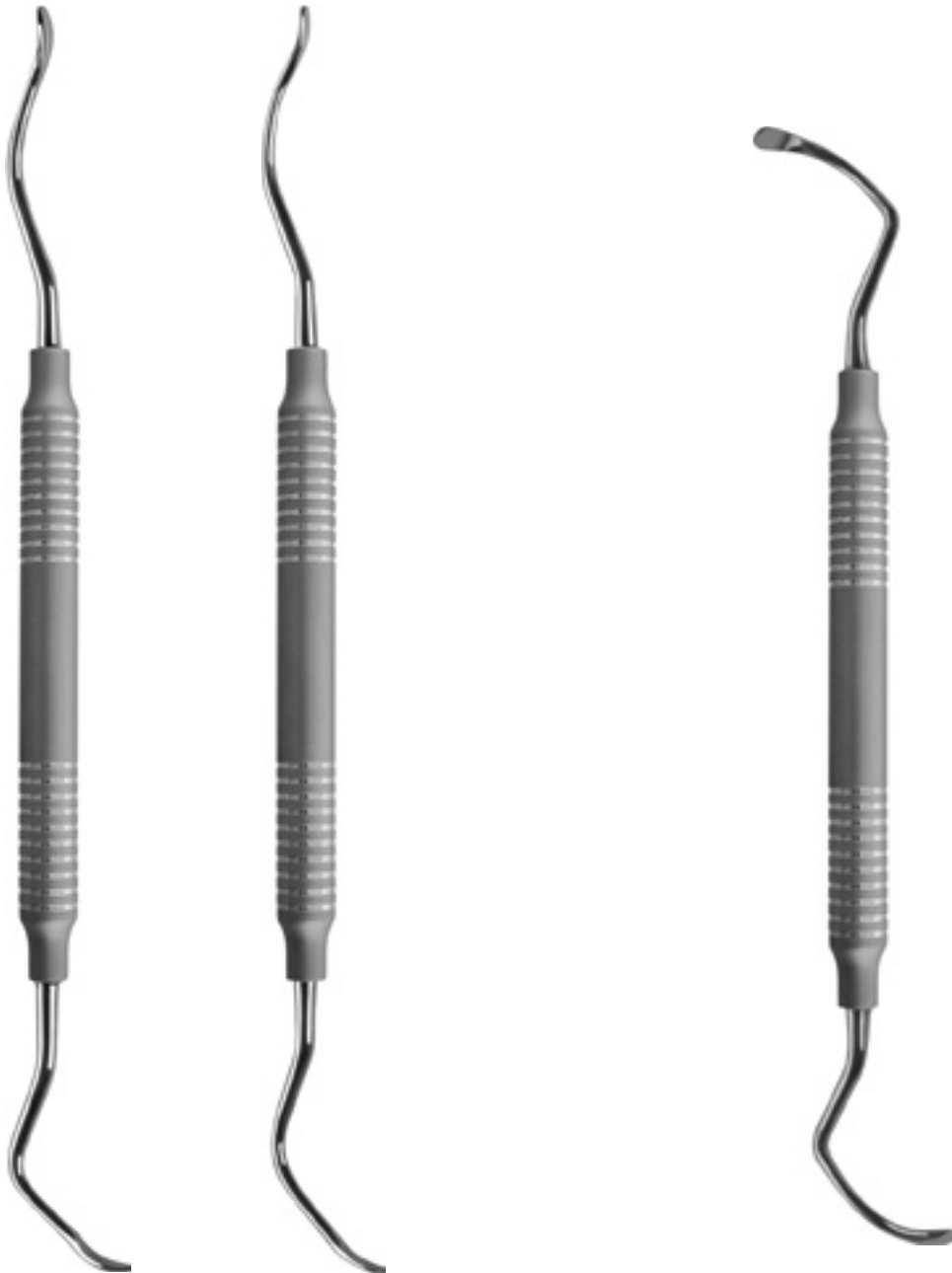

SINUS LIFT CURETTE

	Fig. 1	Fig. 2
170 mm - 6 3/4"	tk 71180-01	tk 71180-02

SINUS LIFT CURETTE

150 mm - 6"	tk 71180-03
-------------	--------------------

Sinus-lift-Instrumente
Sinus-lift instruments

Instruments Sinus-lift
Instrumentos Sinus-lift
Strumenti Sinus-lift

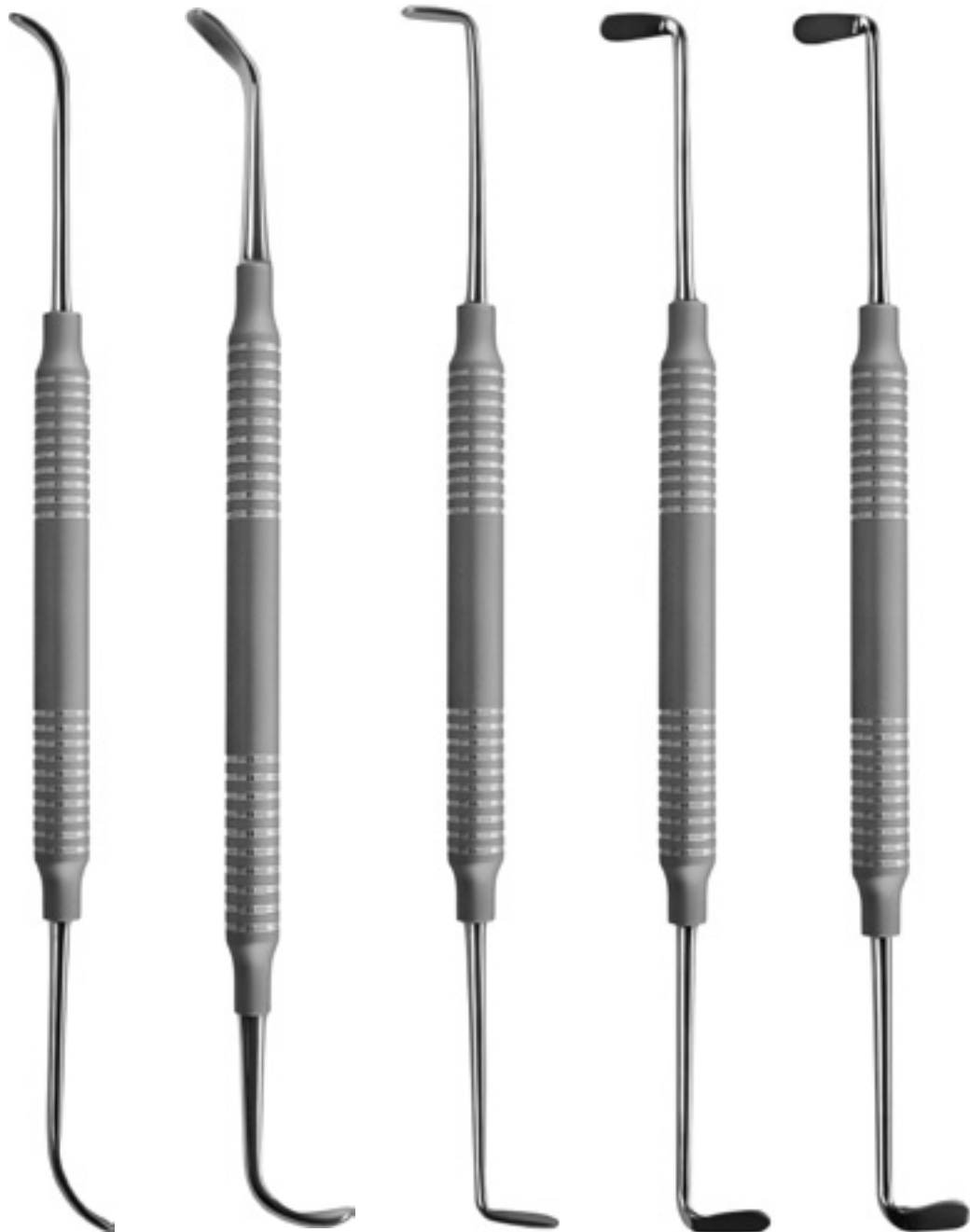

SINUS-LIFT-ELEVATORIUM

	Fig. A1	Fig. A2	Fig. A3	Fig. A4	Fig. A5
170 mm - 6¾"	tk 71181-01	tk 71181-02	tk 71181-03	tk 71181-04	tk 71181-05

Osteotome und Bone Pusher Osteotomes and bone pushers

Osteotom et Bone Pusher Osteotomo y Bone Pusher Osteotomi e spingi ossa



Fig 1, Ø 2.7 mm	tk 72502-01
Fig 2, Ø 3.2 mm	tk 72502-02
Fig 3, Ø 3.7 mm	tk 72502-03
Fig 4, Ø 4.2 mm	tk 72502-04
Fig 5, Ø 5.0 mm	tk 72502-05

Bone Pusher, flach, gerade
Bone pushers flat, straight



Fig 1, Ø 2.7 mm	tk 72505-01
Fig 2, Ø 3.2 mm	tk 72505-02
Fig 3, Ø 3.7 mm	tk 72505-03
Fig 4, Ø 4.2 mm	tk 72505-04
Fig 5, Ø 5.0 mm	tk 72505-05

Bone Pusher, flach, bajonett
Bone pushers, flat, bayonet



Fig 1, Ø 2.7 mm	tk 72501-01
Fig 2, Ø 3.2 mm	tk 72501-02
Fig 3, Ø 3.7 mm	tk 72501-03
Fig 4, Ø 4.2 mm	tk 72501-04
Fig 5, Ø 5.0 mm	tk 72501-05

Osteotome, konvex, gerade
Osteotomes, convex, straight



Fig 1, Ø 2.7 mm	tk 72504-01
Fig 2, Ø 3.2 mm	tk 72504-02
Fig 3, Ø 3.7 mm	tk 72504-03
Fig 4, Ø 4.2 mm	tk 72504-04
Fig 5, Ø 5.0 mm	tk 72504-05

Osteotome, konvex, bajonett
Osteotomes, convex, bayonet



Fig 1, Ø 2.7 mm	tk 72503-01
Fig 2, Ø 3.2 mm	tk 72503-02
Fig 3, Ø 3.7 mm	tk 72503-03
Fig 4, Ø 4.2 mm	tk 72503-04
Fig 5, Ø 5.0 mm	tk 72503-05

Osteotome, konkav, gerade
Osteotomes, concave, straight



Fig 1, Ø 2.7 mm	tk 72506-01
Fig 2, Ø 3.2 mm	tk 72506-02
Fig 3, Ø 3.7 mm	tk 72506-03
Fig 4, Ø 4.2 mm	tk 72506-04
Fig 5, Ø 5.0 mm	tk 72506-05

Osteotome, konkav, bajonett
Osteotomes, concave, bayonet



170 mm – 6 $\frac{3}{4}$ "

tk 72500-00

Handgriff
Handle

Knochenentnahme und -applikation
Bone removal and application

Prélèvement et application de matériel d'os
Toma y aplicación de material de huesos
 Strumenti per prelievo ed applicazione ossa



BUSER

	3mm / 4mm	3 mm / 5 mm	4 mm / 5mm
170 mm - 6 3/4 "	tk 71182-01	tk 71182-02	tk 71182-03



Knochenentnahme und -applikation
Bone removal and application

Prélèvement et application de matériel d'os
Toma y aplicación de material de huesos
Strumenti per prelievo ed applicazione ossa



x =	9.2 mm	5.9 mm
170 mm - 6¾"	tk 71183-03	tk 71183-04
y =	4.7 mm	2.0 mm

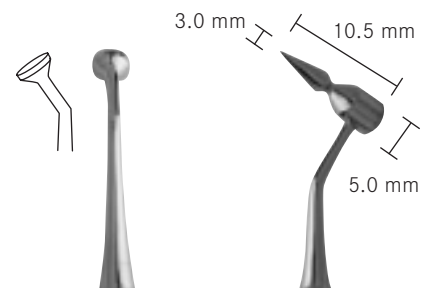

x =	5.0 mm	-
170 mm - 6¾"	tk 71183-06	tk 71183-07
y =	7.5 mm	7.5 mm



PALTI

x =	10.5 mm
170 mm - 6¾"	tk 71183-01
y =	6.0 mm



STEIGMANN

x =	6.0 mm
170 mm - 6¾"	tk 71183-02
y =	7.5 mm



JAVANOVIC

x =	3.0 mm
170 mm - 6¾"	tk 71183-05
y =	3.0 mm



Knochenentnahme und -applikation
Bone removal and application

Prélèvement et application de matériel d'os
Toma y aplicación de material de huesos
Strumenti per prelievo ed applicazione ossa



170 mm - 6 3/4"	tk 6334-17
-----------------	-------------------

Absaugkanüle mit Filter ø 9 mm für Knochenmaterial
Bone aspirator with filter ø 9 mm for bone material



9.0 mm	tk 6334-00
--------	-------------------

Ersatzfilter für tk 6334-17
Replacemant filter for tk 6334-17



0,05 l	50 mm Ø x 50 mm	tk 83155-50
--------	-----------------	--------------------

Medizinbecher, graduert, matt, 18/8 rostfrei
Medicine cup, graduated, tarnished, 18/8 stainless steel



170 mm - 6 3/4" / ø 2.5 mm 3.5 mm	tk 71184-01
170 mm - 6 3/4" / ø 3.5 mm 4.5 mm	tk 71184-02
170 mm - 6 3/4" / ø 4.5 mm 5.5 mm	tk 71184-03
170 mm - 6 3/4" / ø 6.0 mm 7.0 mm	tk 71184-04

Applikator für Knochenersatzmaterial
Applicator for bone grafting material

BUSER

170 mm - 6 3/4" / 2 mm 2mm	tk 71183-08
------------------------------	--------------------

Membran Platzierungsinstrument
Membrane positioning instrument



Knochenmühle
Bone mill

Broyeur d'os
Molino de huesos
Mulino per ossa



200 mm - 8"

tk 71445-00



COTTLE

tk 51649-00

Knochenmühle
bone mill
moulin d'os
molino de huesos
mulino per ossa



Prothetik | Prothèse
Prothodetics | *Prótesis*
Prothetica

Abdrucklöffel
Impression Trays

Porte empreintes
Cubetas de impresiones
Portaimpronte

Fig. 1	Fig. 2	Fig. 3
tk 72180-01	tk 72180-02	tk 72180-03

für bezahnte Oberkiefer, ungelocht
for toothed upper jaws, unperforated

Fig. 4	Fig. 5
tk 72180-04	tk 72180-05

für bezahnte Oberkiefer, ungelocht
for toothed upper jaws, unperforated



Fig. 1	Fig. 2	Fig. 3
tk 72185-01	tk 72185-02	tk 72185-03

für bezahnte Unterkiefer, ungelocht
for toothed lower jaws, unperforated

Fig. 4	Fig. 5
tk 72185-04	tk 72185-05

für bezahnte Unterkiefer, ungelocht
for toothed lower jaws, unperforated



Abdrucklöffel
Impression Trays

Porte empreintes
Cubetas de impresiones
Portaimpronte



Fig. 1	Fig. 2	Fig. 3	Fig. 4
tk 72181-01	tk 72181-02	tk 72181-03	tk 72181-04

für bezahnte Oberkiefer, ungelocht
for toothed upper jaws, unperforated

Fig. 1	Fig. 2	Fig. 3	Fig. 4
tk 72188-01	tk 72188-02	tk 72188-03	tk 72188-04

für bezahnte Oberkiefer, gelocht
for toothed upper jaws, perforated

Fig. 1	Fig. 2
tk 72183-01	tk 72183-02

für partiell bezahnte Oberkiefer, ungelocht
for partially toothed upper jaws, unperforated

Fig. 1	Fig. 2	Fig. 3
tk 72190-01	tk 72190-02	tk 72190-03

für partiell bezahnte Oberkiefer, gelocht
for partially toothed upper jaws, perforated

Fig. 1	Fig. 2
tk 72182-01	tk 72182-02

für unbezahnte Oberkiefer, ungelocht
for edentulous upper jaws, unperforated

Fig. 1	Fig. 2	Fig. 3
tk 72189-01	tk 72189-02	tk 72189-03

für unbezahnte Oberkiefer, gelocht
for edentulous upper jaws, perforated

Abdrucklöffel
Impression Trays

 Porte empreintes
Cubetas de impresiones
 Portaimpronte

Fig. 0	Fig. 1	Fig. 2	Fig. 3	Fig. 4
tk 72186-00	tk 72186-01	tk 72186-02	tk 72186-03	tk 72186-04

 für bezahnte Unterkiefer, ungelocht
for toothed lower jaws, unperforated

Fig. 0	Fig. 1	Fig. 2	Fig. 3	Fig. 4
tk 72192-00	tk 72192-01	tk 72192-02	tk 72192-03	tk 72192-04

 für bezahnte Unterkiefer, gelocht
for toothed lower jaws, perforated

Fig. 1	Fig. 2
tk 72184-01	tk 72184-02

 für partiell bezahnte Unterkiefer, ungelocht
for partially toothed lower jaws, unperforated

Fig. 1	Fig. 2	Fig. 3
tk 72191-01	tk 72191-02	tk 72191-03

 für partiell bezahnte Unterkiefer, gelocht
for partially toothed lower jaws, perforated

Fig. 1	Fig. 2
tk 72187-01	tk 72187-02

 für unbezahnte Unterkiefer, ungelocht
for toothless lower jaws, unperforated

Fig. 1	Fig. 2	Fig. 3
tk 72193-01	tk 72193-02	tk 72193-03

 für unbezahnte Unterkiefer, gelocht
for edentulous lower jaws, perforated

Abdrucklöffel
Impression Trays

Porte empreintes
Cubetas de impresiones
Portaimpronte



Fig. 2

tk 72194-01

ungelocht
unperforated

Fig. 2

tk 72194-02

gelocht
perforated



Fig. 2

tk 79194-03

ungelocht
unperforated

Fig. 2

tk 72194-04

gelocht
perforated



tk72195-01

mit drehbarem Griff und
Stellschraube, ungelocht
with swivel handle and fixing
screw, unperforated



tk72195-02

mit drehbarem Griff und
Stellschraube, gelocht
with swivel handle and fixing
screw, perforated



tk 72195-03

mit drehbarem Griff und
Fixierschieber, gelocht
with swivel handle and slide,
perforated



SCHEUFELE

110 mm - 4 1/4"

tk72196-11



SCHEUFELE

130 mm - 5"

tk72196-13

Wachsmesser, Messinstrument
Wax knife, measuring instruments

Couteaux à cire, instrument de mesure
Cunchillos para cera, instrumento de medición
Coltelli per cera, Strumenti per misurare



FAHNENSTOCK

125 mm - 5"	tk 7006-12	-
180 mm - 7"	-	tk 7006-18

Wachsmesser
Wax knife



100 mm - 4"	tk 71514-00
-------------	--------------------

Messinstrument
Tasterzirkel für Metall und Porzellan
Compass for metal and ceramic

Tamponstopfer | Porte coton
 Tampon plugger | Porta algodones
 Porta tamponi

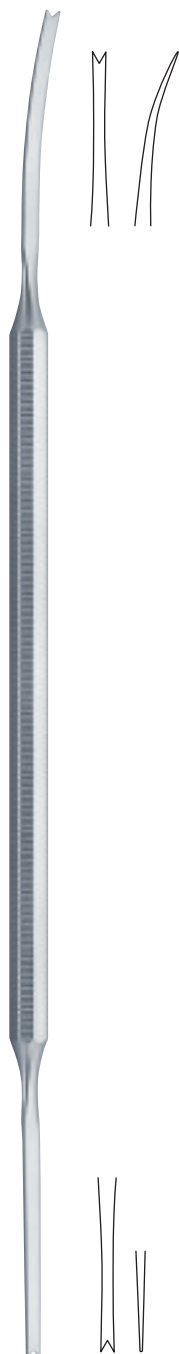

LUNIATSCHEK

Width	3 mm
180 mm - 7"	tk 52610-19

Tamponstopfer
 Tampon plugger



LUNIATSCHEK

Width	2.5 mm
180 mm - 7¼"	tk 71269-01

Tamponstopfer
 Tampon plugger

Kroneninstrumente
Instruments for crown work

Instruments pour couronnes
Instrumentos para coronas
Strumenti per corone



160 mm - 6¼"
tk 71448-00

Kronentferner
Crown remover

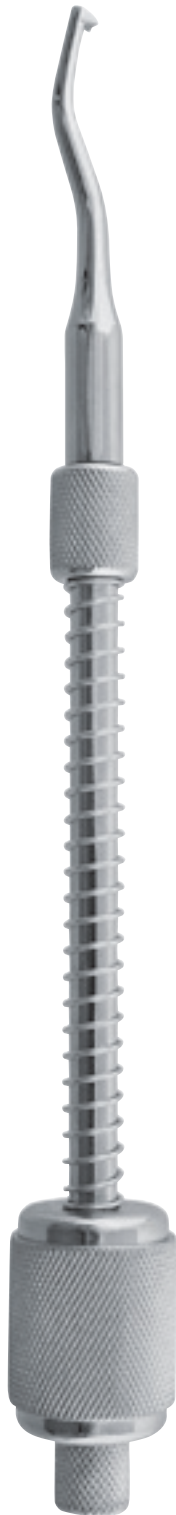

AUTOMATIC
205 mm - 8"
tk 71450-00

Kronenabnehmer
Crown remover



AUTOMATIC
140 mm - 5½"
tk 71451-00

Kronenabnehmer
Crown remover



Fig. 1
tk 71451-01

Einsatz für tk 71451-00
Insert for tk 71451-00



Fig. 2
tk 71451-02

Einsatz für tk 71451-00
Insert for tk 71451-00



Fig. 3
tk 71451-03

Einsatz für tk 71451-00
Insert for tk 71451-00



FURRER
150 mm - 6"
tk 71490-15

Kronenabnehmzange
Crown removing forceps

Kroneninstrumente
Instruments for crown work

Instruments pour couronnes
Instrumentos para coronas
 Strumenti per corone

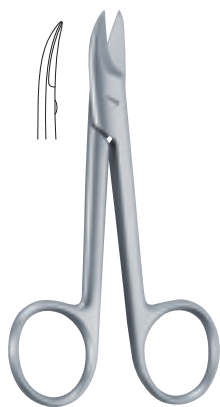

BEEBEE

120 mm - 4 1/4"

tk 9593-12

Kronenschere
Crown scissor



BEEBEE

100 mm - 3 1/4"

tk 9613-10

Kronenschere, gezahnt
Crown scissor, saw edge



140 mm - 5 1/2"

tk 71454-14

Kronenspreizzange
Crown spreader



WYNNANN

170 mm - 6 3/4"

tk 71452-17

Aufnahmezange für Provisorien
Seizing forceps for transitional prothesis



DR. MAZOUCH

155 mm - 6"

tk 71453-15

Kronenaufbieger
Crown spreader

Kroneninstrumente
Instruments for crown work

Instruments pour couronnes
Instrumentos para coronas
Strumenti per corone



160 mm - 6¼"

tk 71455-16

Inlay-Pinzette, 45° gebogen, inkl. 10 Stück Ersatzsilikonplatten
Inlay forceps, 45° curved, incl. 10 pcs of replacement silicone plates



tk 71455-00

1 Stück Ersatzsilikonplatte für tk 71455-16
1 replacement silicone plate for tk 71455-16



15 g

tk 71461-00

Haftpulver für Art. Nr. 71460-14
Powder for Art No 71460-14



tk 71462-00

Lederbacken für Art. Nr. 71460-14 (150 Stück)
Leather inserts for Art No 71460-14 (150 pcs)



140 mm - 5½"

tk 71456-14

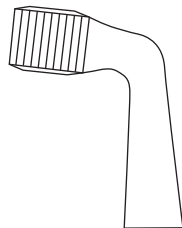

tk 71456-00

1 Stück Gummieinsatz für tk 71456-14
1 Rubber insert for tk 71456-14



140 mm - 5½"

tk 71460-14

Kronenzange mit Lederbacken
Crown forceps with leather inserts

Kroneninstrumente
Instruments for crown work

Instruments pour couronnes
Instrumentos para coronas
Strumenti per corone



130 mm - 5"

tk 71457-01

starr/starr
rigid/rigid



130 mm - 5"

tk 71457-02

beweglich/beweglich
moveable/moveable



130 mm - 5"

tk 71457-03

starr/beweglich
rigid/moveable



tk 71457-04

Ersatzspitze für tk 71457-01 und tk 71457-03
Replacement tip for tk 71457-01 and tk 71457-03



tk 71457-05

Ersatzspitze für tk 71457-02 und tk 71457-03
Replacement tip for tk 71457-02 and tk 71457-03



Orthodontie | Orthodontie
Orthodontics | *Ortodontia*
| Ortodonzia

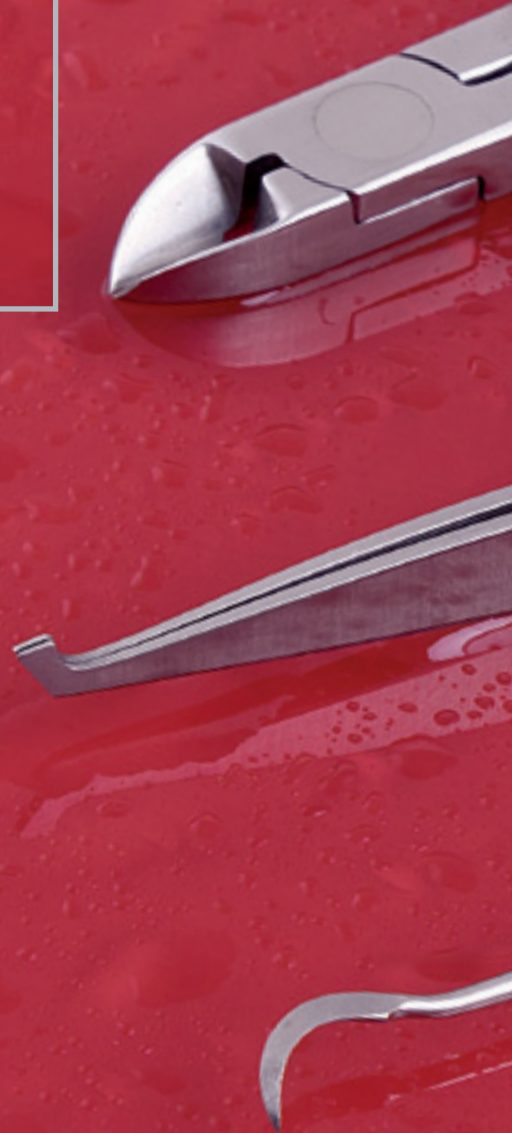

Bracket-Faß-Pinzetten
Bracket forceps

Pince à saisir Brackets
Pinza para coger Brackets
Pinzette porta bracket

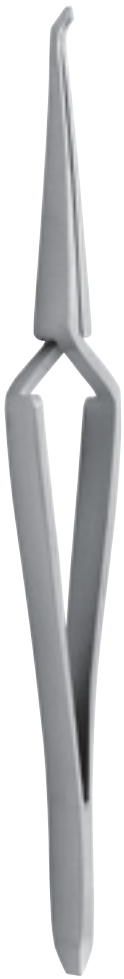

130 mm - 5"

tk 73400-01

Bracket-Klemmpinzette,
hinteres Ende dient zum
Angulieren von Brackets
Bracket forceps



130 mm - 5"

tk 73400-03

Bracket-Klemmpinzette,
Spitzen fassen passen
unter den Bracketflügel,
hinteres Ende dient zum
Angulieren von Brackets
Bracket forceps,
delicate jaws



115 mm - 4½"

tk 73400-07

Bracket-Klemmpinzette,
hinteres Ende dient zum
Angulieren von Brackets
Bracket forceps



135 mm - 5"

tk 73400-09

Bracket-Klemmpinzette
Bracket forceps

Orthodontiezangen
Orthodontic pliers

Pinces pour l'orthodontie
Pinzas para la ortodoncia
Pinze ortodontiche

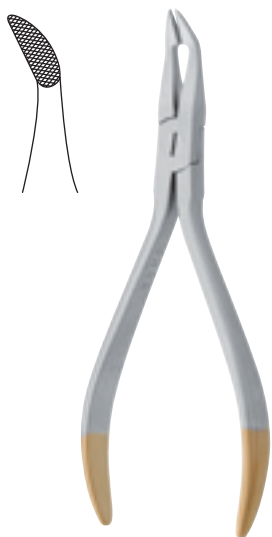

WEINGART

140 mm - 5"

tk 73389-23

Graziles Modell mit
Hartmetalleinsätzen
Delicate model with
tungsten carbide inserts

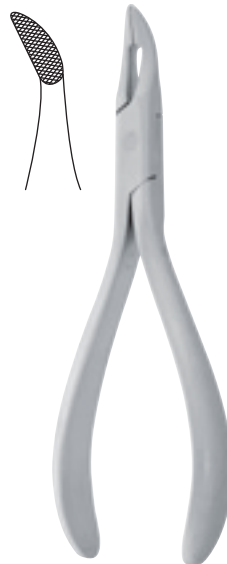

WEINGART

150 mm - 6"

tk 73389-13

Universalzange für Drähte bis Ø 0,5 mm hart
Universal forceps for hard wires up to 0.5 mm



ANGLE (TWEED)

130 mm - 5"

tk 73379-12

Bogenbiegezange für Vierkantdrähte bis
Ø 0,55 x 0,71 mm
Wire and arch bending plier for square
tubular wires 0.55 x 0.71 mm



ANGLE

135 mm - 5¼"

tk 73361-13

Drahtbiegezange mit einer flachen und einer
runden Backe für Drähte bis Ø 0,7 mm
Wire bending forceps with one flat and one
round jaw for hard wires up to Ø 0.7 mm

Orthodontiezangen
Orthodontic pliers

Pinces pour l'orthodontie
Pinzas para la ortodoncia
Pinze ortodontiche



How

140 mm - 5½"

tk 73368-01

Zange, gerade, zum Ansetzen
von Frontzahnbindern

*Forceps, straight, for the
application of front teeth tapes*

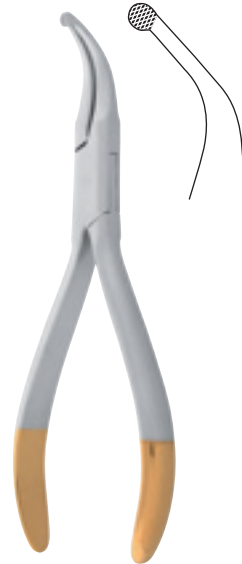

How

145 mm - 5¾"

tk 73368-02

Zange, gebogen, zum Ansetzen
von Zahnbindern an unteren
Frontzähnen

*Forceps, curved, for the
application of lower front teeth
tapes*



MATHIEU

140 mm - 5½"

tk 20600-14

Nadelhalter mit Hartmetalleinlagen
Needle holder with tungsten carbide inserts



MATHIEU

140 mm - 5½"

tk 20100-14

Nadelhalter
Needle holder

Orthodontiezangen
Orthodontic pliers

Pinces pour l'orthodontie
Pinzas para la ortodoncia
Pinze ortodontiche



TWEED STANDARD

140 mm - 5½"

tk 73390-33

Schlaufenbiegezange für Drähte bis Ø 0,5 mm hart
Loop bending forceps for hard wires up to 0.5 mm



YOUNG

135 mm - 5"

tk 73378-13

Schlaufenzange für Schleifen in beliebiger Abmessung,
für Drähte bis Ø 0,7 mm hart
Loop bending forceps for loops of any size, for hard
wires up to 0.7 mm



HALSTED-
MOSQUITO

125 mm - 5"

tk 12010-12

Orthodontiezangen
Orthodontic pliers

Pinces pour l'orthodontie
Pinzas para la ortodoncia
Pinze ortodontiche



135 mm - 5"

tk 73394-13

Bracket Abnehmezange, gerade
auch zum Entfernen von Kleberesten
Bracket removing forceps



140 mm - 5"

tk 73395-13

Bracket Abnehmezange, abgewinkelt
für Seitenzahnbereich
Bracket removing forceps, side-curved

Orthodontiezangen
Orthodontic pliers

Pinces pour l'orthodontie
Pinzas para la ortodoncia
Pinze ortodontiche

tk 73391-01

Biegestift allein, für 73391-14
Bending pin, only, for 73391-14

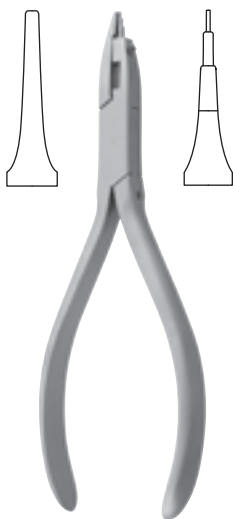

TWEED LOOP

135 mm - 5½"

tk 73391-14

Schlaufenbiegezange mit auswechselbarem
Biegestift, für Drähte bis Ø 0,5 mm hart
Loop bending forceps with exchangeable pin
for hard wires up to Ø 0.5 mm

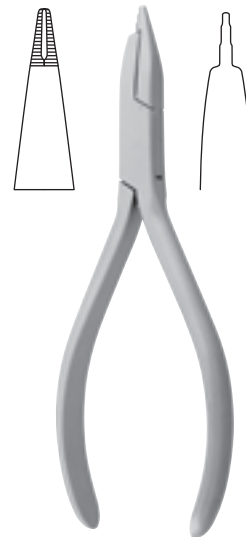

O'BRIAN

140 mm - 5½"

tk 73390-13

Schlaufenbiegezange
Loop bending forceps

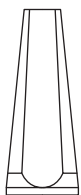

MC KELLOPS

160 mm - 6¼"

tk 73384-16



UNIVERSAL

160 mm - 6¼"

tk 73383-16

Orthodontiezangen
Orthodontic pliers

Pinces pour l'orthodontie
Pinzas para la ortodoncia
Pinze ortodontiche

TUCARTK



130 mm - 5"

tk 73415-12

Distalschneider mit Drahtfangvorrichtung, mit Einsätzen aus Hartmetall, für Drähte bis Ø 0,54 x 0,71 mm

Distal cutter with safety device, tungsten carbide insert, for wires from Ø 0.54 x 0.71 mm

Ligaturenverstecker / Zementkratzer
Ligatures Passer / Utility-Instrument

Instrument pour ligatures / Instrument pour ciment
Aplicador para Ligaduras / Rascador para cemento
 Strumenti per ligatura / Raschiatori



170 mm - 6¾"

tk 73396-00



170 mm - 6¾"

tk 73395-00

Ligator für Elastics
Ligator for elastics



170 mm - 6¾"

tk 73397-00

Ligatureinstrument
Ligature instrument



170 mm - 6¾"

tk 73398-00

Bandaufsetz- und
 Abnehmeinstrument
*Scaler/Pusher, Tape
 Applier and Remover*

Orthodontie Instrumente
Orthodontic instruments

Instruments pour l'orthodontie
Instrumentos para la ortodoncia
Strumenti per ortodonzia



200 mm - 8"

tk 71515-00

Bandsetzer mit zwei auswechselbaren Spitzen, Schlag einstellbar
Tape application forceps with two exchangeable tips, adjustable



tk 71515-01

Spitze allein, gerade
Tip only, straight



tk 71515-02

Spitze allein, abgewinkelt
Tip only, side curved



MERSHON

130 mm - 5"

tk 71510-00

Bandandrücker
Tape Applier

Drahtschneidezangen
Wire cutting forceps

Pinces coupantes
Alicates para cortar alambre
Pinze taglia filo



125 mm - 5"

tk 73412-12

Ligaturschneidezange mit
Einsätzen aus Hartmetall, für
Drähte bis Ø 0,4/0,6 mm weich
*Ligature cutter with tungsten
carbide inserts for soft wires up
to Ø 0.4/0.6 mm*



130 mm - 5"

tk 73410-12

Ligaturschneidezange mit
Einsätzen aus Hartmetall, für
Drähte bis Ø 0,4 mm weich
*Ligature cutter with tungsten
carbide inserts for soft wires up
to Ø 0.4 mm*



230 mm - 9"

tk 38554-23 tucar

für harte Drähte bis 2.2 mm Ø, für weiche Drähte bis 3 mm Ø
for hard wires up to 2.2 mm Ø, for soft wires up to 3 mm Ø



150 mm - 6"

tk 38556-15 tucar

für harte Drähte bis 1 mm Ø, für weiche
Drähte bis 1.5 mm Ø
*for hard wires up to 1 mm Ø, for soft
wires up to 1.5 mm Ø*



145 mm - 5 3/4"

tk 38561-14 tucar

für harte Drähte bis 1 mm Ø
for hard wires up to 1 mm Ø

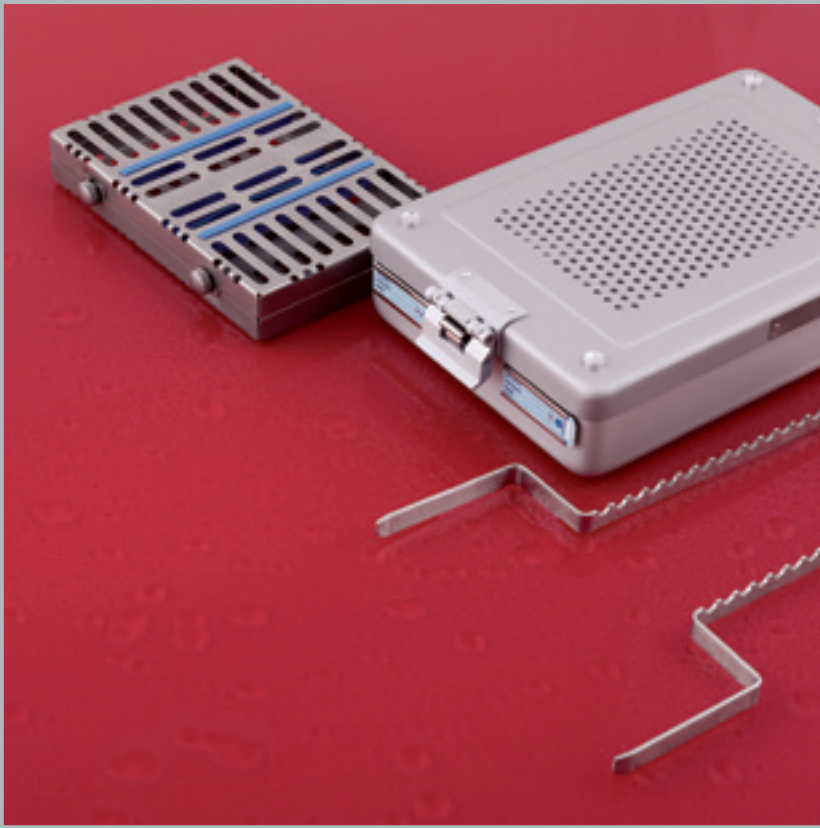







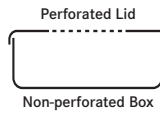











<p>Praxisorganisation <i>Practice Organisation</i></p>	<p>Organisation du cabinet <i>Organización del consultorio</i> Organizzazione dello studio</p>
--	--

Dental Container und Zubehör
Dental containers and accessories

Contenaires dentaires et accessoires
 Contenedores dentales y accesorios
 Container dentale ed accessori



310 x 190 x 40 mm		tk 87005-1F-SI
310 x 190 x 65 mm		tk 87105-1F-SI
310 x 190 x 130 mm		tk 87115-1F-SI
310 x 190 x 40 mm		tk 87005-1F-YE
310 x 190 x 65 mm		tk 87105-1F-YE
310 x 190 x 130 mm		tk 87115-1F-YE
310 x 190 x 40 mm		tk 87005-1F-GR
310 x 190 x 65 mm		tk 87105-1F-GR
310 x 190 x 130 mm		tk 87115-1F-GR
310 x 190 x 40 mm		tk 87005-1F-BL
310 x 190 x 65 mm		tk 87105-1F-BL
310 x 190 x 130 mm		tk 87115-1F-BL
310 x 190 x 40 mm		tk 87005-1F-RE
310 x 190 x 65 mm		tk 87105-1F-RE
310 x 190 x 130 mm		tk 87115-1F-RE
310 x 190 x 40 mm		tk 87005-1F-BK
310 x 190 x 65 mm		tk 87105-1F-BK
310 x 190 x 130 mm		tk 87115-1F-BK

Außenmaße (LxBxH)

Deckelfarbe

outer dimensions (LxWxH)

Lid color

Dental Container und Zubehör
Dental containers and accessories

Contenaires dentaires et accessoires
Contenedores dentales y accesorios
 Container dentale ed accessori



274 x 172 x 43 mm | **tk 87011-01**

Drahtkorb
Wire Basket



165 x 27 mm | **tk 87018-01**

Trennwand
Divider



275 x 180 mm | **tk 87023-04**

Tuchhalter
Drape Retainer

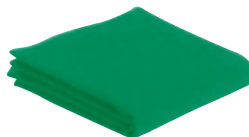

600 x 400 mm | **tk 87026-01**

650 x 650 mm | **tk 87026-02**

850 x 850 mm | **tk 87026-03**

Einschlagtuch
Drape



1 pc. | **tk 87021-01**

Mehrweg Textilfilter
Long term textile filter



100 pcs. | **tk 87020-02**

Einweg Papierfilter
Single use paper filter

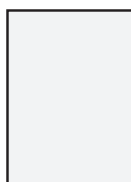





1 pc. | **tk 87022-02**

Dauerfilter für Dentalcontainer
Permanent filter for dental container

Weiteres Zubehör
Additional accessories

Accessoires additionnels
Accesorios adicionales
Accessori suppletivi



	tk 87025-04
	tk 87025-03
	tk 87025-02
	tk 87025-01
	tk 87025-00

Aluminium Plaketten, nach Wunsch graviert, max. 16 Stellen
Aluminium Plates, engraved upon request, max. 16 letters



tk 87001-01

Plakettenspender, 5 Kammern
Label dispenser, 5 spaces



tk 87001-02

Plakettenspender, 10 Kammern
Label dispenser, 10 spaces



tk 87021-12

Filterhalter für Dental Container
Filter holder for Dental Container



tk 87029-01

Papieretikett für Kleinsysteme (100 Stück)
Paper label for small size containers (100 pcs.)



tk 87028-00

Sicherheitsplombe, Kunststoff (100 Stück)
Security seal, plastic (100 pcs.)

Dental Container und Zubehör
Dental containers and accessories

Contenaires dentaires et accessoires
Contenedores dentales y accesorios
Container dentale ed accessori

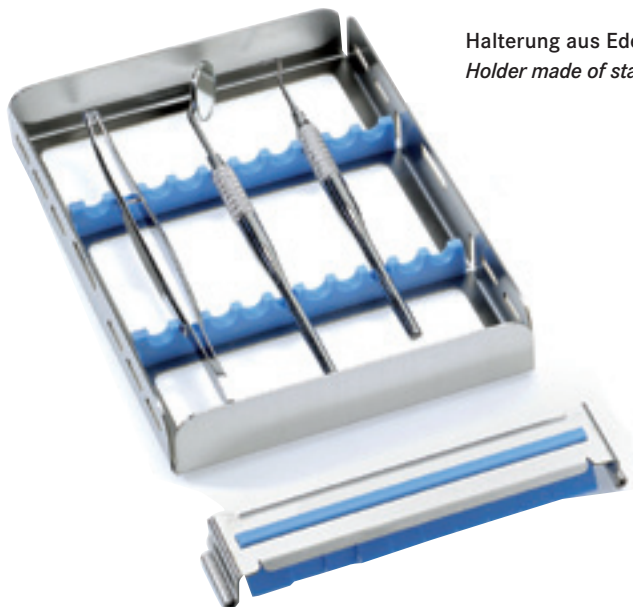

Halterung aus Edelstahl mit Clip und Silikoneinlage
Holder made of stainless steel with Clip and silicone holders

180 x 64 x 27 mm	tk 75000-04	3
180 x 95 x 27 mm	tk 75000-05	5
180 x 136 x 27 mm	tk 75000-06	10

Instrumente
Instruments

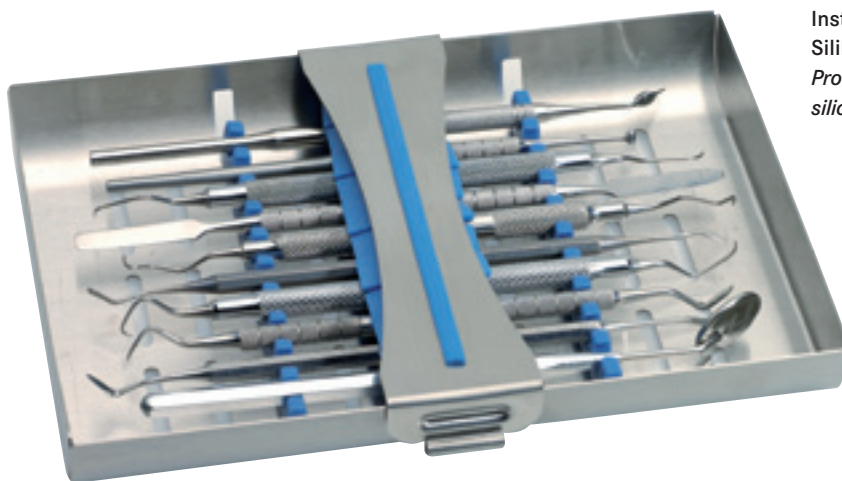

Instrumentenschutz aus Edelstahl mit Clip und Silikoneinlage
Protector made of stainless steel with Clip and silicone holders

184 x 80 x 25 mm	tk 75001-04	3
184 x 110 x 25 mm	tk 75001-05	5
184 x 150 x 25 mm	tk 75001-06	10

Instrumente
Instruments

Dental Container und Zubehör
Dental containers and accessories

Contenaires dentaires et accessoires
Contenedores dentales y accesorios
Container dentale ed accessori

Instrumentenschutz aus Edelstahl mit Deckel und blauer Silikoneinlage
Stainless steel protector for instruments, with lid and blue silicone insert



187 x 150 x 25 mm	tk 75002-01
230 x 187 x 25 mm	tk 75002-02
288 x 187 x 25 mm	tk 75002-03

Instrumentenschutz aus Edelstahl mit Clip und blauer Silikoneinlage
Stainless steel protector for instruments, with clip and blue silicone insert



230 x 184 x 25 mm	tk 75002-04
288 x 184 x 25 mm	tk 75002-05

Instrumentenkassette aus Edelstahl, mit Silikoneinlage
Stainless steel cassettes for instruments, with silicone holders



180 x 60 x 25 mm	tk 75003-03	5
180 x 140 x 25 mm	tk 75003-04	10

Instrumente
Instruments

Instrumentenkassette aus Edelstahl, mit Silikoneinlage
Stainless steel cassettes for instruments, with silicone holders



185 x 140 x 34 mm	tk 75004-01	8
270 x 170 x 34 mm	tk 75004-02	10
280 x 180 x 34 mm	tk 75004-03	16

Instrumente
Instruments

Dental Container und Zubehör
Dental containers and accessories

Contenaires dentaires et accessoires
Contenedores dentales y accesorios
Container dentale ed accessori



180 x 140 x 19 mm	tk 75007-01
280 x 180 x 19 mm	tk 75006-01

Tablett, ungelocht, Edelstahl
Tray non perforated, stainless steel

180 x 140 x 19 mm	tk 75007-02
280 x 180 x 19 mm	tk 75006-02

Tablett gelocht, Edelstahl
Tray perforated, stainless steel

180 x 140 x 25 mm	tk 75007-03
280 x 180 x 25 mm	tk 75006-03

Deckel ungelocht, Edelstahl
Cover non perforated, stainless steel

180 x 140 x 25 mm	tk 75007-04
280 x 180 x 25 mm	tk 75006-04

Deckel gelocht, Edelstahl
Cover perforated, stainless steel



for 280 x 180 mm	tk 75006-06
------------------	--------------------

Gestell aus Edelstahl alleine für 6 Tablett und Deckel, Edelstahl
Stainless steel rack alone for 6 trays and covers, stainless steel

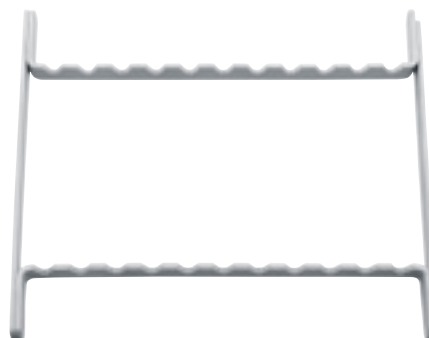

for 280 x 180 mm	tk 75006-05
------------------	--------------------

Instrumentenhalter für 11 Instrumente, Edelstahl
Instrument Holder for 11 Instruments, stainless steel

for 180 x 140 mm	tk 75007-05
------------------	--------------------

Instrumentenhalter für 7 Instrumente, Edelstahl
Instrument Holder for 7 Instruments, stainless steel



for 180 x 140 mm	tk 75007-06
------------------	--------------------

Gestell aus Edelstahl alleine für 6 Tablett und Deckel, Edelstahl
Stainless steel rack alone, for 6 trays and covers, stainless steel

Dental Container und Zubehör
Dental containers and accessories

Contenaires dentaires et accessoires
 Contenedores dentales y accesorios
 Container dentale ed accessori



280 x 180 x 19 mm	tk 75008-01	
280 x 180 x 19 mm	tk 75008-02	
280 x 180 x 19 mm	tk 75008-03	
280 x 180 x 19 mm	tk 75008-04	
280 x 180 x 19 mm	tk 75008-05	
280 x 180 x 19 mm	tk 75008-06	

Tablett, ungelocht, Aluminium Farbe
Tray non perforated, Aluminium Color

280 x 180 x 19 mm	tk 75009-01	
280 x 180 x 19 mm	tk 75009-02	
280 x 180 x 19 mm	tk 75009-03	
280 x 180 x 19 mm	tk 75009-04	
280 x 180 x 19 mm	tk 75009-05	
280 x 180 x 19 mm	tk 75009-06	

Tablett, gelocht, Aluminium Farbe
Tray perforated, Aluminium Color

280 x 180 x 25 mm	tk 75010-01	
-------------------	--------------------	---

Deckel, ungelocht, Aluminium Farbe
Cover, not perforated, Aluminium Color

280 x 180 x 25 mm	tk 75010-02	
-------------------	--------------------	---

Deckel, gelocht, Aluminium Farbe
Cover, perforated, Aluminium Color

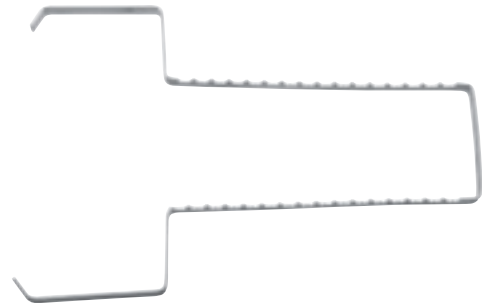

tk 75010-03

Halter für 16 Instrumente, Aluminium
Holder for 16 instruments, Aluminium

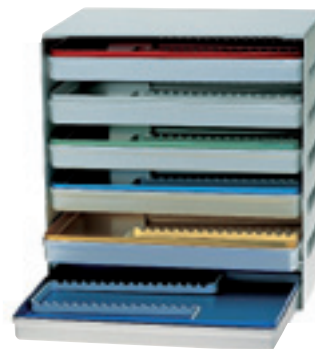

tk 75010-04

Gestell allein aus Aluminium für 6 Trays und Deckel
Aluminium rack alone for 6 trays and covers

10

Dental Container und Zubehör
Dental containers and accessories

Contenaires dentaires et accessoires
Contenedores dentales y accesorios
 Container dentale ed accessori

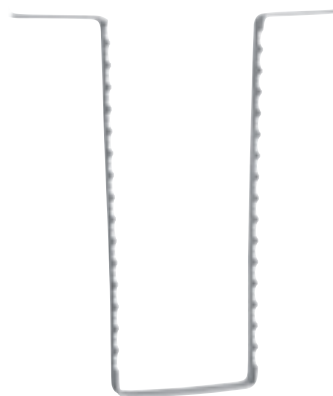

180 x 140 x 19 mm	tk 75011-01	
180 x 140 x 19 mm	tk 75011-02	
180 x 140 x 19 mm	tk 75011-03	
180 x 140 x 19 mm	tk 75011-04	
180 x 140 x 19 mm	tk 75011-05	
180 x 140 x 19 mm	tk 75011-06	

Tablett, ungelocht, Aluminium Farbe
Tray non perforated, Aluminium Color

180 x 140 x 19 mm	tk 75012-01	
180 x 140 x 19 mm	tk 75012-02	
180 x 140 x 19 mm	tk 75012-03	
180 x 140 x 19 mm	tk 75012-04	
180 x 140 x 19 mm	tk 75012-05	
180 x 140 x 19 mm	tk 75012-06	

Tablett, gelocht, Aluminium Farbe
Tray perforated, Aluminium Color

180 x 140 x 25 mm	tk 75013-01	
-------------------	--------------------	--

Deckel, ungelocht, Aluminium Farbe
Cover, not perforated, Aluminium Color

180 x 140 x 25 mm	tk 75013-02	
-------------------	--------------------	--

Deckel, gelocht, Aluminium Farbe
Cover, perforated, Aluminium Color

tk 75013-03

Halter für 16 Instrumente, Aluminium
Holder for 16 instruments, Aluminium



tk 75013-04

Gestell allein aus Aluminium für 6 Trays und Deckel
Aluminium rack alone for 6 trays and covers

Pflegemittel – Spezial Ölspray
Detergent – special oil spray

Détergent – spray huileux
Detergente – spray de aceite
 Detergente – olio speciale spray



100 ml

tk 95100-00



TEKNO Spezial Öl zur Instrumentenpflege
TEKNO special oil for surgical instruments

tk 95000-00

Indikation und Anwendung:

- Zum Schmieren gereinigter chirurgischer Instrumente, auch solcher mit Gelenken
- Das Einsprühen erfolgt nach der Reinigung und vor der Sterilisation der Instrumente mit Dampf, Gas oder Heißluft (bis 200°C)
- Eignet sich zur Verwendung in der Zentralsterilisation ebenso wie in kleineren Sterilisations-Einheiten, sowie in der ärztlichen, zahnärztlichen und der tierärztlichen Praxis

Technische Daten – Bestellinformationen

Merkmale:

- Hauptbestandteil: flüssiges Paraffin
- Enthält keine Silikonanteile
- Sprühkopf mit spezieller Sprühkanüle

Vorteile:

- Verringert die Anfälligkeit für Fleckenbildung und Verfärbung
- Vermindert Eiweiß- und Mineralablagerungen
- Ein mikrofeiner Ölfilm ermöglicht ein leichtes und schnelles Reinigen der Instrumente
- Durch die hohe Kriechfähigkeit gelangt das Paraffinöl selbst in feinste Gelenke und Schlüsse
- Verlängert die Lebensdauer der Instrumente und reduziert die Notwendigkeit von Reparaturen
- Verlängert die Schneidfähigkeit von Scheren
- Rostvorbeugend
- Physiologiosch unbedenklich
- Vermeidet Krustenbildung auf den Instrumentenoberflächen
- Sprühstrahl kann gezielt in Gelenke und Steckverschlüsse gerichtet werden
- Sparsam im Gebrauch

Indication and application:

- To lubricate cleaned surgical instruments, also with boxlocks or pivot joints
- The spray is applied on instruments after cleaning and drying but prior to sterilization by steam, gas or hot air (up to 200°C)
- May be used in central sterilization departments, as well as in smaller sterilization units, or in medical, dental and veterinary surgeries

Technical data – order information

Feature:

- Lubricant: Paraffinum liquidum
- Free of silicone components
- Nozzle head with special spray cannula

Advantages:

- Reduces staining and spotting
- Less protein- and mineral deposits on the instrument surface
- Facilitates quick and easy instrument cleaning
- Paraffin oil reaches even the smallest boxlocks or pivot joints
- Prolongs the shelf life of surgical instruments and helps to reduce repairs
- Prolongs the sharpness of scissors and blades
- Rust preventive
- Preventive lubrication
- Physiologically harmless
- Avoids incrustation on instrument surfaces
- Allows precise spraying directly into pivot joints and boxlocks
- Economical



ATRIA 1



ATRIA 2



ATRIA 3



ATRIA 5



Bitte fordern Sie unseren Spezialkatalog an.
Please ask for our special catalogue.

*Veillez demander pour notre catalogue spécial.
Por favor preguntan para el catálogo especial.*

Per favore domandate per il nostro catalogo speciale.

Instrumentensätze
Instrument sets

Jeux d'instruments
Juegos de instrumentos
Set di strumenti

Instrumentensatz für die Parodontologie
Periodontal instrument set

Jeu d'instruments pour la parodontologie
Juego de instrumentos para la parodontología
Set strumenti per parodontologia

PERIODONTAL INSTRUMENT SET

tk73500-01

CRANE-KAPLAN [pos 01]	left			150 mm	tk70081-15	→ 47
CRANE-KAPLAN [pos 02]	right			150 mm	tk70080-15	→ 47
GOLDMAN-FOX [pos 03]	curved, serrated			130 mm	tk9923-13	→ 151
GRACEY STANDARD [pos 04]	Fig. 1-2, TEKNO-HANDLE			174 mm	tk71280-01	→ 28
GRACEY STANDARD [pos 05]	Fig. 5-6, TEKNO-HANDLE			174 mm	tk71280-05	→ 28
GRACEY STANDARD [pos 06]	Fig. 9-10, TEKNO-HANDLE			174 mm	tk71280-09	→ 28
GRACEY STANDARD [pos 07]	Fig. 13-14, TEKNO-HANDLE			174 mm	tk71280-13	→ 29
GOLDMAN-FOX [pos 08]	Scaler, Fig. 21, TEKNO-HANDLE			174 mm	tk71212-10	→ 43
KIRKLAND [pos 09]	Periodontal knife, Fig. 15K-16K TEKNO-HANDLE			170 mm	tk71290-01	→ 46
ORBAN [pos 10]	Periodontal knife, Fig.1-2, TEKNO-HANDLE			170 mm	tk71290-02	→ 46
CRANE-KAPLAN [pos 11]	Scaler, Fig. CK6, TEKNO-HANDLE			174 mm	tk71212-06	→ 42
TOWNER-JAQUETTE [pos 12]	Scaler, Fig. U15-33, TEKNO-HANDLE			174 mm	tk71213-03	→ 40
MOLT [pos 13]	Raspatory, Fig. 9, 4,5/7,5MM, TEKNO-HANDLE			105 mm	tk52733-04	→ 195
[pos 14]	Periodontometer, Fig. CP11, TEKNO-HANDLE			160 mm	tk71306-25	→ 24
[pos 15]	Stainless Steel Cassettes for instruments, with silicone holders			280 x 180 x 34 mm	tk75004-03	→ 246











Instrumentensatz Gracey Küretten
Gracey curettes set

Jeu des curettes Gracey
Juego de curetes Gracey
Set strumenti di curette Gracey

GRACEY CURETTES SET

tk 73500-02









GRACEY STANDARD [pos 01]	Fig. 1-2, TEKNO-HANDLE 	174 mm	tk 71280-01	→ 28
GRACEY STANDARD [pos 02]	Fig. 3-4, TEKNO-HANDLE 	174 mm	tk 71280-03	→ 28
GRACEY STANDARD [pos 03]	Fig. 5-6, TEKNO-HANDLE 	174 mm	tk 71280-05	→ 28
GRACEY STANDARD [pos 04]	Fig. 7-8, TEKNO-HANDLE 	174 mm	tk 71280-07	→ 28
GRACEY STANDARD [pos 05]	Fig. 9-10, TEKNO-HANDLE 	174 mm	tk 71280-09	→ 28
GRACEY STANDARD [pos 06]	Fig. 11-12, TEKNO-HANDLE 	174 mm	tk 71280-11	→ 28
GRACEY STANDARD [pos 07]	Fig. 13-14, TEKNO-HANDLE 	174 mm	tk 71280-13	→ 29
[pos 08]	Stainless Steel Cassettes for instruments, with silicone holders 	180 x 140 x 25 mm	tk 75003-04	→ 246

Instrumentensatz zur Mikrochirurgie
Micro surgery Set

Jeu d'instruments pour la micro chirurgie
Juego de instrumentos para la micro cirugía
Set per microchirurgia

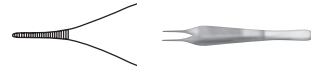
MICRO SURGERY SET

tk 73500-03















CASTROVIEJO- JACOBSEN [pos 01]	<i>Needle holder straight, with ratchet</i> 	180 mm	tk 20210-18 D	→ 189
CASTROVIEJO [pos 02]	<i>Micro scissors, straight, 8 mm</i> 	150 mm	tk 25610-15	→ 152
CASTROVIEJO [pos 03]	<i>Micro scissors, curved, 8 mm</i> 	150 mm	tk 25611-15	→ 152
[pos 04]	<i>Retractor, sharp, 2 teeth, flexible</i> 	160 mm	tk 17021-16	→ 170
MICRO- ADSON [pos 05]	<i>Dressing forceps</i> 	120 mm	tk 10503-12	→ 157
SEMKEN [pos 06]	<i>Tissue forceps, 1x2 teeth</i> 	150 mm	tk 11300-15	→ 160
[pos 07]	<i>Micro forceps with guide pin, tying platform, 0,5 mm, curved</i> 	180 mm	tk 25687-35	→ 161
[pos 08]	<i>Micro-blade holder, titanium</i> 	135 mm	tk 7120-13	→ 140
[pos 09]	<i>Stainless Steel Cassettes for instruments, with silicone holders</i> 	280 x 180 x 34 mm	tk 75004-03	→ 246

Instrumentensatz für die Paradontalchirurgie
Periodontal surgery set

Jeu d'instruments pour le paradontologie chirurgicale
 Juego de instrumentos para la paradontología quirúrgica
 Set strumenti per la chirurgia parodontale

PERIODONTAL SURGERY SET

tk 73500-04

[pos 01]	Scalpel handle, Fig. 3			tk 7110-03	→ 141
CAEWOOD-MINNESOTA [pos 02]	Cheek holder		155 mm	tk 5494-15	→ 178
FREER [pos 03]	Raspatory, Fig. 1, 5,0/5,0 mm, TEKNO-HANDLE		174 mm	tk 52733-07	→ 195
DE BAKEY [pos 04]	Atraumatic forceps, 1,5 mm		145 mm	tk 11960-14	→ 162
WESTCOTT [pos 05]	Iridectomy scissors curved, SH/SH		115 mm	tk 9263-11	→ 153
CASTROVIEJO-JACOBSON [pos 05]	Needle holder straight, with ratchet		150 mm	tk 20210-15 D	→ 189
[pos 07]	Peridontometer, Fig. CP11, TEKNO-HANDLE		160 mm	tk 71306-25	→ 24
[pos 08]	Suction tube, 3mm		140 mm	tk 6330-14	→ 137
GRACEY STANDARD [pos 09]	Curette, Fig. 5-6, TEKNO-HANDLE		174 mm	tk 71280-05	→ 28
GRACEY STANDARD [pos 10]	Curette, Fig. 7-8, TEKNO-HANDLE		174 mm	tk 71280-07	→ 28
GRACEY STANDARD [pos 11]	Curette, Fig. 11-12, TEKNO-HANDLE		174 mm	tk 71280-11	→ 28
GRACEY STANDARD [pos 12]	Curette, Fig. 13-14, TEKNO-HANDLE		174 mm	tk 71280-13	→ 29
[pos 13]	Scaler, Fig. 204 S, TEKNO-HANDLE		174 mm	tk 71212-02	→ 42
[pos 14]	Probes and explorers, Fig. 23		174 mm	tk 71100-23	→ 21

Instrumentensatz Wurzelheber
Root elevators set

Jeu d'élevateurs
Juego de elevadores
Set strumenti di elevatori

ROOT ELEVATORS SET

tk73500-05

[pos 01]	HYLIN Root elevators 3 mm, Fig. 2		140 mm	tk70211-02	→ 78
[pos 02]	SINUS-LIFT Root elevators 3 mm, Fig. 3		170 mm	tk70211-03	→ 210
[pos 03]	SINUS-LIFT Root elevators 3 mm, Fig. 4		170 mm	tk70211-04	→ 210
[pos 04]	SINUS-LIFT Root elevator, Fig. 1		140 mm	tk70208-01	→ 72
[pos 05]	SINUS-LIFT Elevator, Fig. a5, TEKNO-HANDLE		170 mm	tk71181-05	→ 210
[pos 06]	Protector made os stainless steel with clip and silicone holders		184 x 110 x 25 mm	tk75001-05	→ 245

Instrumentensatz Wurzelheber Root elevators set	Jeu d'élévateurs Juego de elevadores Set strumenti di leve
--	--

TK-LUX SET

tk 73500-06











[pos 01]	Root elevator, Fig. 1		140 mm	tk 70208-01	→ 72
[pos 02]	Root elevator, Fig. 2		140 mm	tk 70208-02	→ 72
[pos 03]	Root elevator, Fig. 3		140 mm	tk 70208-03	→ 72
[pos 04]	Root elevator, Fig. 4		140 mm	tk 70208-04	→ 72
[pos 05]	Root elevator, Fig. 5		140 mm	tk 70208-05	→ 72
[pos 06]	Root elevator, Fig. 6		140 mm	tk 70208-06	→ 72
[pos 07]	Root elevator, Fig. 7		140 mm	tk 70208-07	→ 72
[pos 08]	Root elevator, Fig. 8		140 mm	tk 70208-08	→ 72
[pos 09]	Root elevator, Fig. 9		140 mm	tk 70208-09	→ 72

Instrumentensatz zur Zahnentfernung
Extraction Set

Jeu d'instruments pour l'extraction
Juego de instrumentos para extracción
Set per estrazioni

EXTRACTION SET FOR UPPER/LOWER MOLARS - WISDOM

tk73500-07

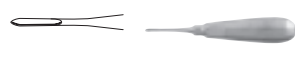









PRICHARD [pos 01]	Raspatory, Fig. 3, 4,5/10,5mm TEKNO-HANDLE 	174 mm	tk52733-08	→ 195
CRILE- WOOD [pos 02]	Needle holder, tc 	150 mm	tk20502-15 TC	→ 181
[pos 03]	Iris scissors, straight 	115 mm	tk9432-11	→ 154
[pos 04]	Extracting forceps, english pattern, Fig. 51 a 	170 mm	tk70100-79	→ 97
[pos 05]	Extracting forceps, english pattern, Fig. 67 a 	185 mm	tk70100-51 A	→ 90
[pos 06]	Extracting forceps, english pattern, Fig. 33 	180 mm	tk70100-67 A	→ 92
[pos 07]	Extracting forceps, english pattern, lower roots 	155 mm	tk70100-33	→ 95
WHITE [pos 08]	Extracting forceps, english pattern, special type 	170 mm	tk70104-00	→ 100
APICAL [pos 09]	Root elevator, Fig. 302 	160 mm	tk70206-02	→ 76
APICAL [pos 10]	Root elevator, Fig. 303 	160 mm	tk70206-03	→ 76
APICAL [pos 11]	Root elevator, Fig. 304 	160 mm	tk70206-04	→ 76

Instrumentensatz zur Zahnentfernung
Extraction Set

Jeu d'instruments pour l'extraction
Juego de instrumentos para extracción
Set per estrazioni

SET OF TOOTH FORCEPS

tk 73500-08









[pos 01]	Extracting forceps, english pattern, Fig. 2		170 mm	tk 70100-02	→ 86
[pos 02]	Extracting forceps, english pattern, Fig. 13		155 mm	tk 70100-13	→ 93
[pos 03]	Extracting forceps, english pattern, Fig. 33		155 mm	tk 70100-33	→ 95
[pos 04]	Extracting forceps, english pattern, Fig. 51		185 mm	tk 70100-51	→ 90
[pos 05]	Extracting forceps, english pattern, Fig. 7		160 mm	tk 70100-07	→ 86
[pos 06]	Extracting forceps, english pattern, Fig. 17		170 mm	tk 70100-17	→ 87
[pos 07]	Extracting forceps, english pattern, Fig. 18		170 mm	tk 70100-18	→ 87
[pos 08]	Extracting forceps, english pattern, Fig. 22		155 mm	tk 70100-22	→ 94
[pos 09]	Extracting forceps, english pattern, Fig. 67		180 mm	tk 70100-67	→ 92
[pos 10]	Extracting forceps, english pattern, Fig. 79		170 mm	tk 70100-79	→ 97

Instrumentensatz zur Zahnentfernung
Extraction Set

Jeu d'instruments pour l'extraction
Juego de instrumentos para extracción
Set per estrazioni

ROOTS SET

tk 73500-09

[pos 01]	<i>Extracting forceps, special type, Fig. 5</i>		150 mm	tk 70104-59 L	→ 100
[pos 02]	<i>Extracting forceps, special type, Fig. 51</i>		190 mm	tk 70104-51 LX	→ 90
[pos 03]	<i>Extracting forceps, english pattern, Fig. 49</i>		190 mm	tk 70100-49	→ 89
[pos 04]	<i>Extracting forceps, english pattern, Fig. 29</i>		170 mm	tk 70100-29	→ 88
[pos 05]	<i>Extracting forceps, english pattern, Fig. 45</i>		185 mm	tk 70100-45	→ 96
[pos 06]	<i>Extracting forceps, english pattern, Fig. 74</i>		150 mm	tk 70100-74	→ 96
HEIDBRINK [pos 07]	<i>Root fragment elevator, 1,7 mm</i>		190 mm	tk 71020-11	→ 81
HEIDBRINK [pos 08]	<i>Root fragment elevator, 2,1 mm</i>		190 mm	tk 71020-12	→ 81



Instrumentensatz zur Zahnentfernung
Extraction Set

Jeu d'instruments pour l'extraction
Juego de instrumentos para extracción
Set per estrazioni

EXTRACTING FORCEPS FOR CHILDREN

tk 73500-10









[pos 01]	Extracting forceps, english pattern, for children, Fig. 37		135 mm	tk 70110-37	→ 101
[pos 02]	Extracting forceps, english pattern, for children, Fig. 39		135 mm	tk 70110-39	→ 101
[pos 03]	Extracting forceps, english pattern, for children, Fig. 39 R		135 mm	tk 70110-39 R	→ 101
[pos 04]	Extracting forceps, english pattern, for children, Fig. 39 L		135 mm	tk 70110-39 L	→ 101
[pos 05]	Extracting forceps, english pattern, for children, Fig. 51 S		135 mm	tk 70110-51 S	→ 102
[pos 06]	Extracting forceps, english pattern, for children, Fig. 13 S		130 mm	tk 70110-13 S	→ 103
[pos 07]	Extracting forceps, english pattern, for children, Fig. 30 S		135 mm	tk 70110-30 S	→ 102
[pos 08]	Extracting forceps, english pattern, for children, Fig. 33 S		130 mm	tk 70110-33 S	→ 103
[pos 09]	Extracting forceps, english pattern, for children, Fig. 22 S		130 mm	tk 70110-22 S	→ 103
[pos 10]	Extracting forceps, english pattern, for children, Fig. 38		135 mm	tk 70110-38	→ 103

Instrumentensatz zur Zahnentfernung
Extraction Set

Jeu d'instruments pour l'extraction
Juego de instrumentos para extracción
Set per estrazioni

PEDODONTIC TOOTH FORCEPS, AMERICAN PATTERN

tk 73500-11





[pos 01]	<i>Extracting forceps, american pattern, Fig. 65</i>		180 mm	tk 70120-65	→ 110
[pos 02]	<i>Extracting forceps, american pattern, Fig. 69</i>		180 mm	tk 70120-69	→ 110
[pos 03]	<i>Extracting forceps, american pattern, Fig. 16</i>		175 mm	tk 70120-16	→ 107
[pos 04]	<i>Extracting forceps, american pattern, Fig. 17</i>		180 mm	tk 70120-17	→ 108
[pos 05]	<i>Extracting forceps, american pattern, Fig. 18 L</i>		180 mm	tk 70120-18 L	→ 108
[pos 06]	<i>Extracting forceps, american pattern, Fig. 18 R</i>		180 mm	tk 70120-18 R	→ 108
[pos 07]	<i>Extracting forceps, american pattern, Fig. 150</i>		175 mm	tk 70120-150	→ 112
[pos 08]	<i>Extracting forceps, american pattern, Fig. 151</i>		180 mm	tk 70120-151	→ 113
[pos 09]	<i>Extracting forceps, american pattern, Fig. 203</i>		170 mm	tk 70120-203	→ 114

Rubber Dam Instrumentensatz
Rubber dam instrument set

Jeu d'instruments à digue
Juego de instrumentos para dique de caucho
Set die strumenti per diga

RUBBER DAM INSTRUMENT SET

tk 73500-12







	<i>Rubber dam holder, satin finished</i>			tk 71500-00	→ 134
[pos 01]					
IVORY	<i>Rubber dam clamp forceps, satin finished</i>		170 mm	tk 71505-16	→ 133
[pos 02]					
IVORY	<i>Rubber dam clamp forceps, satin finished</i>		150 mm	tk 71501-16	→ 133
[pos 03]					
[pos 04]	<i>Stainless Steel Cassettes for instruments, with silicone holders</i>		280 x 180 x 34 mm	tk 75004-03	→ 246

Sinus-lift Instrumentensatz
Sinus lift Set

Jeu d'instruments pour sinus lift
Juego de instrumentos para sinus lift
Set per sinus lift

SINUS LIFT SET

tk73500-13

[pos 01]	Sinus lift elevator, Fig. a1, TEKNO-HANDLE		170 mm	tk71181-01	→ 210
[pos 02]	Sinus lift elevator, Fig. a2, TEKNO-HANDLE		170 mm	tk71181-02	→ 210
[pos 03]	Sinus lift elevator, Fig. a3, TEKNO-HANDLE		170 mm	tk71181-03	→ 210
[pos 04]	Sinus lift elevator, Fig. a4, TEKNO-HANDLE		170 mm	tk71181-04	→ 210
[pos 05]	Sinus lift elevator, Fig. a5, TEKNO-HANDLE		170 mm	tk71181-05	→ 210
[pos 06]	Protector made of stainless steel with clip and silicone holders		184 x 110 x 25 mm	tk75001-05	→ 245

Nummernverzeichnis | Index des numéros de référence
Numerical index | *Indice numerico*
Indice dei numeri d'articolo

Nummernverzeichnis
Numerical Index

Index numériques
Indice numerico
Indice dei numeri d'articolo

Art. Nr.	Seite	Art. Nr.	Seite	Art. Nr.	Seite	Art. Nr.	Seite
tk 5410-17	178	tk 8462-18	146	tk 9629-12 TC	154	tk 11964-16	162
tk 5410-90	178	tk 8463-16	146	tk 9672-09	155	tk 12000-10	163
tk 5471-12	178	tk 8463-18	146	tk 9672-11	155	tk 12001-10	163
tk 5471-14	178	tk 8572-14	148	tk 9672-14	155	tk 12010-12	163, 233
tk 5471-16	178	tk 8573-14	148	tk 9672-18	155	tk 12010-14	163
tk 5479-01	178	tk 8582-16	150	tk 9672-20	155	tk 12011-12	163
tk 5479-02	178	tk 8587-16	150	tk 9922-13	151	tk 12011-14	163
tk 5485-15	179	tk 8592-12	150	tk 9922-13 SU	151	tk 12012-12	163
tk 5487-19	179	tk 8597-12	150	tk 9923-13	151	tk 12012-14	163
tk 5488-10	179	tk 8632-11	149	tk 9923-13 SU	151	tk 12013-12	163
tk 5488-15	179	tk 8633-11	149	tk 9924-13 SUTC	151	tk 12013-14	163
tk 5488-20	179	tk 8636-11 TC	149	tk 9925-13 SUTC	151	tk 12020-10	163
tk 5494-15	178	tk 8637-11 TC	149			tk 12020-12	163
tk 5496-17	179	tk 8642-09	149	tk 10200-15	156	tk 12021-10	163
tk 5497-16	179	tk 8643-09	149	tk 10200-18	156	tk 12021-12	163
tk 6330-14	137	tk 8652-09	149	tk 10200-20	156	tk 12022-10	163
tk 6330-18	137	tk 8652-10	149	tk 10300-12	156	tk 12022-12	163
tk 6330-19	137	tk 8652-10 SU	149	tk 10300-15	156	tk 12023-10	163
tk 6331-03	137	tk 8652-11	149	tk 10327-15	162	tk 12023-12	163
tk 6331-04	137	tk 8653-09	149	tk 10327-18	162	tk 12040-14	164
tk 6331-06	137	tk 8653-10	149	tk 10328-18	162	tk 12040-16	164
tk 6332-03	137	tk 8653-10 SU	149	tk 10328-20	162	tk 12041-14	164
tk 6332-04	137	tk 8653-11	149	tk 10400-17	156	tk 12041-16	164
tk 6332-06	137	tk 8852-17	154	tk 10401-17	156	tk 12050-14	164
tk 6333-16	137	tk 9193-14 TC	148	tk 10402-17 TC	160	tk 12050-16	164
tk 6334-00	214	tk 9198-14	148	tk 10500-12	157	tk 12051-14	164
tk 6334-17	214	tk 9198-14 SU	148	tk 10500-15	157	tk 12051-16	164
tk 6397-01	138	tk 9222-01	153	tk 10502-12 TC	157	tk 12052-14	164
tk 6397-02	138	tk 9223-01	153	tk 10502-15 TC	157	tk 12053-14	164
tk 6397-03	138	tk 9230-12	154	tk 10503-12	157	tk 12054-16	164
tk 7006-12	222	tk 9262-11	153	tk 10503-15	157	tk 12055-16	164
tk 7006-18	222	tk 9263-11	153	tk 10504-12 TC	158	tk 12058-13	165
tk 7110-03	141	tk 9432-11	154	tk 10504-15 TC	158	tk 12058-14	165
tk 7110-07	141	tk 9434-11	154	tk 10506-12 TC	158	tk 12058-16	165
tk 7110-71	141	tk 9436-11	154	tk 10506-15 TC	158	tk 12059-13	165
tk 7115-03	141	tk 9532-09	151	tk 10508-12 TC	157	tk 12059-14	165
tk 7116-03	141	tk 9532-13	151	tk 11200-12	158	tk 12059-16	165
tk 7120-13	140	tk 9582-10	155	tk 11200-15	158	tk 12078-13	165
tk 7121-03	140	tk 9582-12	155	tk 11202-12	158	tk 12078-14	165
tk 7121-04	140	tk 9583-10	155	tk 11202-15	158	tk 12078-16	165
tk 7121-07	140	tk 9583-12	155	tk 11204-12	158	tk 12079-13	165
tk 7121-09	140	tk 9592-10	155	tk 11206-12	158	tk 12079-14	165
tk 7210-10 T	142	tk 9592-12	155	tk 11206-12 B	158	tk 12079-16	165
tk 7210-11 T	142	tk 9593-10	155	tk 11206-13	158	tk 12110-12	163
tk 7210-12 DT	142	tk 9593-12	155, 225	tk 11206-15	158	tk 12111-12	163
tk 7210-12 T	142	tk 9602-10	155	tk 11210-12	157	tk 12112-12	163
tk 7210-15 CT	142	tk 9602-12	155	tk 11212-12	157	tk 12113-12	163
tk 7210-15 T	142	tk 9603-10	155	tk 11300-12	160	tk 12140-14	164
tk 7215-13	143	tk 9603-12	155	tk 11300-15	160	tk 12141-14	164
tk 7220-09	143	tk 9612-10	155	tk 11700-10	159	tk 12250-14	164
tk 7225-09	143	tk 9612-12	155	tk 11701-10	159	tk 12251-14	164
tk 7230-10	143	tk 9613-10	155, 225	tk 11703-10	159	tk 12805-09	167
tk 8024-11	147	tk 9613-12	155	tk 11730-10	159	tk 12805-11	167
tk 8193-14 TC	148	tk 9617-09	155	tk 11731-10	159	tk 12805-13	167
tk 8198-14	148	tk 9617-11	155	tk 11733-10	159	tk 15100-25	167
tk 8198-14 SU	148	tk 9618-09	155	tk 11960-12	162	tk 15100-27	167
tk 8333-14	146	tk 9618-11	155	tk 11960-14	162	tk 15101-25	167
tk 8337-14	147	tk 9620-10	154	tk 11960-16	162	tk 15101-27	167
tk 8462-16	146	tk 9622-12	154	tk 11964-14	162	tk 15110-20	167

Nummernverzeichnis
Numerical Index

Index numériques

Indice numerico

Indice dei numeri d'articolo

Art. Nr.	Seite	Art. Nr.	Seite	Art. Nr.	Seite	Art. Nr.	Seite
tk 15110-22	167	tk 20035-16	185	tk 20549-12 TC	186	tk 24295-12	204
tk 15111-20	167	tk 20036-12	183	tk 20570-13	188	tk 24295-15	204
tk 15111-22	167	tk 20036-14	183	tk 20570-15	188	tk 24295-18	204
tk 17021-16	170	tk 20036-17	183	tk 20570-17	188	tk 24480-11	192
tk 17022-16	170	tk 20036-19	183	tk 20600-14	232	tk 24480-22	192
tk 17024-16	170	tk 20100-14	232	tk 20610-17 tucar	184	tk 24480-33	192
tk 17031-16	170	tk 20106-14	183	tk 20610-20 tucar	184	tk 24482-01	192
tk 17032-16	170	tk 20106-17	183	tk 20615-17 tucar	185	tk 24482-02	192
tk 17034-16	170	tk 20106-20	183	tk 20615-20 tucar	185	tk 24485-00	191
tk 17038-08	170	tk 20200-14	190	tk 20622-20 tucar	185	tk 24485-01	191
tk 17038-10	170	tk 20201-14	190	tk 20704-15 DTC	189	tk 24485-12	191
tk 17038-12	170	tk 20204-15 D	189	tk 20704-18 DTC	189	tk 24487-00	191
tk 17038-14	170	tk 20204-18 D	189	tk 20704-21 DTC	189	tk 24487-01	191
tk 17038-16	170	tk 20204-21 D	189	tk 20705-15 DTC	189	tk 24487-12	191
tk 17038-18	170	tk 20205-15 D	189	tk 20705-18 DTC	189	tk 24489-01	191
tk 17039-10	171	tk 20205-18 D	189	tk 20705-21 DTC	189	tk 24489-10	191
tk 17039-17	171	tk 20205-21 D	189	tk 20710-14 DTC	189	tk 24489-20	191
tk 17039-20	171	tk 20210-14 D	189	tk 20710-15 DTC	189	tk 24490-01	191
tk 17039-22	171	tk 20210-15 D	189	tk 20710-18 DTC	189	tk 24490-10	191
tk 17080-16	172	tk 20210-18 D	189	tk 20710-21 DTC	189	tk 24490-20	191
tk 17081-16	172	tk 20210-21 D	189	tk 20711-14 DTC	189	tk 24525-13	193
tk 17082-15	172	tk 20211-14 D	189	tk 20711-15 DTC	189	tk 24525-16	193
tk 17083-01	173	tk 20211-15 D	189	tk 20711-18 DTC	189	tk 24526-16	193
tk 17083-02	173	tk 20211-18 D	189	tk 20711-21 DTC	189	tk 24532-16	193
tk 17084-14	173	tk 20211-21 D	189	tk 24050-17	201	tk 24533-17	193
tk 17085-15	172	tk 20304-13	187	tk 24050-90	201	tk 24535-01	193
tk 17085-21	171	tk 20308-12	181	tk 24051-20	201	tk 24535-02	193
tk 17086-22	171	tk 20502-15 TC	181	tk 24056-19	200	tk 24535-03	193
tk 17087-23	171	tk 20502-18 TC	181	tk 24056-90	200	tk 24535-04	193
tk 17112-01	174	tk 20502-20 TC	181	tk 24077-01	203	tk 24544-17	194
tk 17112-02	174	tk 20503-14 TC	182	tk 24077-02	202	tk 24546-17	198
tk 17112-03	174	tk 20504-15 TC	182	tk 24077-03	202	tk 24601-15	206
tk 17112-04	174	tk 20508-12 TC	181	tk 24077-04	202	tk 24602-15	206
tk 17112-05	174	tk 20509-13 TC	182	tk 24077-05	202	tk 24605-12	205
tk 17114-01	174	tk 20510-13 TC	183	tk 24094-03	204	tk 24605-14	205
tk 17114-02	174	tk 20511-13 TC	183	tk 24094-04	204	tk 24606-01	205
tk 17114-03	174	tk 20512-14 TC	184	tk 24094-06	204	tk 24606-02	205
tk 17114-04	174	tk 20512-16 TC	184	tk 24094-08	204	tk 24606-03	205
tk 17114-05	174	tk 20512-18 TC	184	tk 24094-10	204	tk 24613-00	207
tk 17114-06	174	tk 20512-20 TC	184	tk 24094-12	204	tk 24613-02	207
tk 17114-07	174	tk 20516-14 TC	182	tk 24094-15	204	tk 24631-16	206
tk 17114-08	174	tk 20516-17 TC	182	tk 24095-03	204	tk 24635-14	206
tk 17114-09	174	tk 20516-20 TC	182	tk 24095-04	204	tk 24637-17	206
tk 17311-12	177	tk 20522-18 tucar	188	tk 24095-06	204	tk 24650-14	207
tk 17312-15	177	tk 20522-20 tucar	188	tk 24095-08	204	tk 24650-17	207
tk 20001-15	181	tk 20522-23 tucar	188	tk 24095-10	204	tk 24651-14	207
tk 20002-15	181	tk 20522-26 tucar	188	tk 24095-12	204	tk 24651-17	207
tk 20002-18	181	tk 20525-14 TC	187	tk 24095-15	204	tk 25600-15	152
tk 20002-20	181	tk 20525-18 TC	187	tk 24251-15	203	tk 25601-15	152
tk 20003-14	182	tk 20533-13 TC	187	tk 24252-16	203	tk 25610-15	152
tk 20008-12	181	tk 20535-14 TC	186	tk 24253-04	203	tk 25611-15	152
tk 20009-13	182	tk 20535-16 TC	185	tk 24253-06	203	tk 25612-12	152
tk 20010-13	183	tk 20536-12 TC	183	tk 24253-08	203	tk 25613-12	152
tk 20011-13	183	tk 20536-14 TC	183	tk 24254-03	203	tk 25622-01	190
tk 20012-14	184	tk 20536-17 TC	183	tk 24295-02	204	tk 25622-02	190
tk 20012-16	184	tk 20536-19 TC	183	tk 24295-04	204	tk 25622-03	190
tk 20012-18	184	tk 20546-12 TC	186	tk 24295-06	204	tk 25622-04	190
tk 20012-20	184	tk 20547-12 TC	186	tk 24295-08	204	tk 25622-05	190
tk 20035-14	186	tk 20548-12 TC	186	tk 24295-10	204	tk 25622-06	190

Nummernverzeichnis
Numerical Index

Index numériques
Indice numerico
Indice dei numeri d'articolo

Art. Nr.	Seite	Art. Nr.	Seite	Art. Nr.	Seite	Art. Nr.	Seite
tk 25622-07	190	tk 52719-22	176	tk 70050-06	18	tk 70100-75	96
tk 25622-08	190	tk 52723-16	176	tk 70052-01	18	tk 70100-79	97
tk 25686-30	161	tk 52725-08	176	tk 70052-02	18	tk 70100-79 A	97
tk 25686-35	161	tk 52725-10	176	tk 70052-03	18	tk 70100-79 C	97
tk 25687-30	161	tk 52730-06	194	tk 70052-04	18	tk 70100-86 A	98
tk 25687-35	161	tk 52730-07	194	tk 70052-05	18	tk 70100-86 B	98
tk 28100-14	166	tk 52730-09	194	tk 70052-06	18	tk 70100-86 C	98
tk 28140-15	166	tk 52730-11	194	tk 70054-01	19	tk 70100-87	98
tk 28160-15	166	tk 52731-05	194	tk 70054-02	19	tk 70102-01	86
tk 28167-15	166	tk 52731-08	194	tk 70054-03	19	tk 70102-02	86
tk 28192-16	166	tk 52731-09	194	tk 70054-04	19	tk 70102-04	93
tk 38554-23 tucar	239	tk 52733-01	195	tk 70060-03	20	tk 70102-07	86
tk 38556-15 tucar	239	tk 52733-02	195	tk 70060-04	20	tk 70102-13	93
tk 38561-14 tucar	239	tk 52733-03	195	tk 70060-05	20	tk 70102-17	87
tk 40275-20	136	tk 52733-04	195	tk 70060-06	20	tk 70102-18	87
tk 40275-40	136	tk 52733-05	195	tk 70060-08	20	tk 70102-22	94
tk 40276-15	136	tk 52733-06	195	tk 70063-16	20	tk 70102-33	95
tk 40276-20	136	tk 52733-07	195	tk 70064-05	20, 58	tk 70102-51 A	90
tk 40276-40	136	tk 52733-08	195	tk 70064-07	58	tk 70102-67 A	92
tk 40277-20	136	tk 52733-09	196	tk 70064-08	20, 58	tk 70102-74	96
tk 40277-40	136	tk 52733-10	196	tk 70075-12	19	tk 70102-79	97
tk 50581-19	200	tk 52733-11	196	tk 70078-15	136	tk 70104-00	100
tk 51155-01	208	tk 52733-12	196	tk 70079-15	136	tk 70104-22 L	99
tk 51155-02	208	tk 52733-13	196	tk 70079-16	160	tk 70104-22 R	99
tk 51155-03	208	tk 52733-14	196	tk 70080-15	47	tk 70104-35 A	86
tk 51155-04	208	tk 52733-15	196	tk 70081-15	47	tk 70104-51 LX	90
tk 51155-05	208	tk 52738-21	194	tk 70100-01	86	tk 70104-59 L	100
tk 51158-01	208	tk 52740-21	194	tk 70100-02	86	tk 70105-01 MD	105
tk 51158-02	208	tk 70000-22	16	tk 70100-04	93	tk 70105-02 MD	105
tk 51158-03	208	tk 70000-24	16	tk 70100-07	86	tk 70105-03 MD	105
tk 51158-04	208	tk 70000-26	16	tk 70100-13	93	tk 70105-04 MD	105
tk 51160-01	208	tk 70001-22	16	tk 70100-17	87	tk 70106-01	86
tk 51160-02	208	tk 70001-24	16	tk 70100-18	87	tk 70106-02	86
tk 51160-03	208	tk 70001-26	16	tk 70100-18 A	87	tk 70106-04	93
tk 51160-04	208	tk 70002-22	16	tk 70100-19	87	tk 70106-07	86
tk 51160-05	208	tk 70002-24	16	tk 70100-21	93	tk 70106-08 L	99
tk 51161-01	208	tk 70002-26	16	tk 70100-22	94	tk 70106-08 R	99
tk 51161-02	208	tk 70003-22	16	tk 70100-23	94	tk 70106-13	93
tk 51161-03	208	tk 70003-24	16	tk 70100-24	94	tk 70106-17	87
tk 51161-04	208	tk 70003-26	16	tk 70100-29	88	tk 70106-18	87
tk 51161-05	208	tk 70004-22	16	tk 70100-30	88	tk 70106-22	94
tk 51173-12	208	tk 70004-24	16	tk 70100-33	95	tk 70106-33	95
tk 51649-00	215	tk 70004-26	16	tk 70100-33 L	95	tk 70106-34	88
tk 52131-11	168	tk 70005-13	17, 56	tk 70100-41	89	tk 70106-36	95
tk 52131-14	168	tk 70006-13	17	tk 70100-44	89	tk 70106-49	89
tk 52141-12	168	tk 70008-22	16	tk 70100-45	96	tk 70106-51 A	90
tk 52142-14	168	tk 70008-24	16	tk 70100-49	89	tk 70106-51 B	90
tk 52143-00	169	tk 70009-22	16	tk 70100-51	90	tk 70106-66 L	91
tk 52143-11	169	tk 70010-13	17, 56	tk 70100-51 A	90	tk 70106-66 R	91
tk 52143-14	169	tk 70011-13	17	tk 70100-55	91	tk 70106-67 A	92
tk 52144-00	169	tk 70017-03	56	tk 70100-56	100	tk 70106-74	96
tk 52144-13	169	tk 70017-05	56	tk 70100-66 L	91	tk 70106-79	97
tk 52149-16	168	tk 70017-07	56	tk 70100-66 R	91	tk 70106-79 C	97
tk 52149-19	168	tk 70020-14	17, 56	tk 70100-67	92	tk 70110-13 S	103
tk 52610-19	223	tk 70050-01	18	tk 70100-67 A	92	tk 70110-22 S	103
tk 52715-01	175	tk 70050-02	18	tk 70100-68	97	tk 70110-29 S	102
tk 52715-02	175	tk 70050-03	18	tk 70100-73	95	tk 70110-30 S	102
tk 52715-03	175	tk 70050-04	18	tk 70100-74	96	tk 70110-33 S	103
tk 52717-22	176	tk 70050-05	18	tk 70100-74 N	96	tk 70110-37	101

Nummernverzeichnis
Numerical Index

Index numériques

Indice numerico

Indice dei numeri d'articolo

Art. Nr.	Seite	Art. Nr.	Seite	Art. Nr.	Seite	Art. Nr.	Seite
tk70110-38	103	tk70201-03	68	tk70217-12 L	80	tk71070-01	144
tk70110-39	101	tk70201-04	68	tk70217-12 R	80	tk71070-02	144
tk70110-39 L	101	tk70201-05	68	tk70217-13 L	80	tk71087-10	120
tk70110-39 R	101	tk70201-06	68	tk70217-13 R	80	tk71100-08	21
tk70110-51 S	102	tk70201-07	68	tk70217-14 L	80	tk71100-09	21, 57
tk70111-03	104	tk70201-08	68	tk70217-14 R	80	tk71100-17	21
tk70111-05	104	tk70201-14	69	tk70219-41	83	tk71100-23	21, 57
tk70111-06	104	tk70201-15	69	tk70219-42	83	tk71101-08	21
tk70111-07	104	tk70201-16	69	tk70219-43	83	tk71101-09	21, 57
tk70111-137	104	tk70201-17	69	tk70219-44	83	tk71101-17	21
tk70111-139	104	tk70201-18	69	tk70219-45	73	tk71101-23	21, 57
tk70111-51 S	104	tk70201-21	70	tk70219-46	73	tk71115-05	22
tk70120-01	106	tk70201-22	70	tk70219-47	73	tk71115-09	22
tk70120-01 A	106	tk70202-06	67	tk70219-48	73	tk71116-01	22
tk70120-01 B	106	tk70202-07	67	tk70219-49	73	tk71116-05	22
tk70120-06	106	tk70202-08	67	tk70219-50	73	tk71116-09	22
tk70120-10 H	107	tk70203-01	67	tk70219-51	74	tk71120-06	119
tk70120-10 S	106	tk70203-02	67	tk70219-52	74	tk71120-12	119
tk70120-101	111	tk70203-03	67	tk70219-53	74	tk71120-14	119
tk70120-103	112	tk70203-04	67	tk70219-54	74	tk71120-71	119
tk70120-15	107	tk70205-04	77	tk70219-55	74	tk71120-73	119
tk70120-150	112	tk70205-05	77	tk70220-01	75	tk71120-75	119
tk70120-150 A	112	tk70206-01	76	tk70220-02	75	tk71120-77	119
tk70120-150 S	112	tk70206-02	76	tk70220-03	75	tk71120-79	119
tk70120-151	113	tk70206-03	76	tk70220-04	75	tk71127-05	118
tk70120-151 A	113	tk70206-04	76	tk70220-05	75	tk71127-14	118
tk70120-151 S	113	tk70207-27	76	tk70220-06	75	tk71127-17	118
tk70120-16	107	tk70207-28	76	tk70220-07	75	tk71127-18	118
tk70120-16 S	107	tk70207-39	76	tk71018-00	83	tk71127-19	118
tk70120-17	108	tk70207-40	76	tk71018-01	83	tk71127-20	118
tk70120-18 L	108	tk70208-01	72	tk71018-02	83	tk71137-05	123
tk70120-18 R	108	tk70208-02	72	tk71018-03	83	tk71137-05 A	123
tk70120-201	114	tk70208-03	72	tk71020-01	82	tk71137-05 B	123
tk70120-203	114	tk70208-04	72	tk71020-02	82	tk71137-06	123
tk70120-210 H	114	tk70208-05	72	tk71020-03	82	tk71137-07	123
tk70120-222	114	tk70208-06	72	tk71020-08	82	tk71137-10	123
tk70120-23	109	tk70208-07	72	tk71020-09	82	tk71137-11	123
tk70120-286	114	tk70208-08	72	tk71020-11	81	tk71137-12	123
tk70120-32	109	tk70208-09	72	tk71020-12	81	tk71137-13	123
tk70120-32 A	109	tk70208-34	76	tk71020-13	81	tk71137-14	123
tk70120-53 L	109	tk70208-34 S	76	tk71020-14	81	tk71138-00	124
tk70120-53 R	109	tk70210-01	77	tk71020-15	81	tk71138-01	124
tk70120-65	110	tk70210-02	77	tk71020-16	81	tk71138-02	124
tk70120-69	110	tk70210-03	77	tk71025-15	59	tk71138-11	130
tk70120-85	111	tk70211-01	78	tk71026-13	59	tk71138-12	130
tk70120-88 L	111	tk70211-02	78	tk71027-13	59	tk71138-13	130
tk70120-88 R	111	tk70211-03	78	tk71028-13	59	tk71141-64	125
tk70130-17 SK	115	tk70211-04	78	tk71029-11	59	tk71141-65	125
tk70130-23 SK	115	tk70213-20	79	tk71030-15	60	tk71141-66	125
tk70200-01	66	tk70213-21	79	tk71031-15	60	tk71141-67	125
tk70200-02	66	tk70213-22	79	tk71032-01	61	tk71150-05	126
tk70200-03	66	tk70213-23	79	tk71032-02	61	tk71150-06	126
tk70200-04	66	tk70213-70	79	tk71032-03	61	tk71150-07	126
tk70200-05	66	tk70213-71	79	tk71033-01	64	tk71150-09	127
tk70200-06	66	tk70215-00	78	tk71033-02	64	tk71150-10	127
tk70200-07	66	tk70217-01 L	80	tk71033-03	64	tk71150-11	127
tk70200-09	66	tk70217-01 R	80	tk71034-01	65	tk71150-46	126
tk70201-01	68	tk70217-11 L	80	tk71034-02	65	tk71150-47	126
tk70201-02	68	tk70217-11 R	80	tk71034-03	65	tk71150-48	126

Nummernverzeichnis
Numerical Index

Index numériques
Indice numerico
Indice dei numeri d'articolo

Art. Nr.	Seite	Art. Nr.	Seite	Art. Nr.	Seite	Art. Nr.	Seite
tk 71150-58	127	tk 71199-01	121	tk 71282-11	32	tk 71306-35	24
tk 71150-59	127	tk 71199-02	121	tk 71282-12	33	tk 71306-40	24
tk 71150-60	127	tk 71208-11	38	tk 71282-13	33	tk 71315-02	121
tk 71151-01	128	tk 71208-12	38	tk 71282-14	33	tk 71407-00	122
tk 71151-02	128	tk 71208-13	38	tk 71282-15	33	tk 71409-01	122
tk 71151-03	128	tk 71208-14	38	tk 71282-17	33	tk 71409-02	122
tk 71151-04	128	tk 71211-04	39	tk 71283-02	34	tk 71409-03	122
tk 71151-05	128	tk 71211-07	39	tk 71283-03	34	tk 71409-04	122
tk 71151-06	128	tk 71211-56	39	tk 71283-04	34	tk 71445-00	215
tk 71151-07	128	tk 71212-01	42	tk 71283-05	34	tk 71448-00	224
tk 71152-01	129	tk 71212-02	42	tk 71283-06	34	tk 71450-00	224
tk 71152-02	129	tk 71212-03	42	tk 71284-01	35	tk 71451-00	224
tk 71152-03	129	tk 71212-04	42	tk 71284-02	35	tk 71451-01	224
tk 71153-01	129	tk 71212-05	39	tk 71284-03	35	tk 71451-02	224
tk 71153-02	129	tk 71212-06	42	tk 71284-04	35	tk 71451-03	224
tk 71153-03	129	tk 71212-07	43	tk 71284-05	36	tk 71452-17	225
tk 71153-04	129	tk 71212-08	43	tk 71284-06	36	tk 71453-15	225
tk 71154-01	130	tk 71212-09	43	tk 71284-07	36	tk 71454-14	225
tk 71154-02	130	tk 71212-10	43	tk 71284-08	36	tk 71455-00	226
tk 71154-03	130	tk 71212-12	50	tk 71285-01	37	tk 71455-16	226
tk 71154-04	130	tk 71212-23	42	tk 71285-03	37	tk 71456-00	226
tk 71160-01	131	tk 71213-01	40	tk 71285-05	37	tk 71456-14	226
tk 71160-02	131	tk 71213-02	40	tk 71285-17	37	tk 71457-01	227
tk 71160-03	131	tk 71213-03	40	tk 71286-00	197	tk 71457-02	227
tk 71160-04	131	tk 71213-04	40	tk 71286-01	197	tk 71457-03	227
tk 71160-05	131	tk 71213-05	40	tk 71286-02	197	tk 71457-04	227
tk 71160-06	131	tk 71213-06	41	tk 71286-03	197	tk 71457-05	227
tk 71161-01	132	tk 71213-07	41	tk 71286-04	197	tk 71460-14	226
tk 71161-02	132	tk 71213-08	41	tk 71286-09	197	tk 71461-00	226
tk 71162-01	132	tk 71213-09	41	tk 71286-10	197	tk 71462-00	226
tk 71180-01	209	tk 71213-10	41	tk 71286-11	197	tk 71490-15	224
tk 71180-02	209	tk 71269-01	223	tk 71286-12	197	tk 71500-00	134
tk 71180-03	209	tk 71278-02	26	tk 71286-13	198	tk 71501-16	133
tk 71181-01	210	tk 71278-04	26	tk 71286-24	198	tk 71505-16	133
tk 71181-02	210	tk 71278-13	26	tk 71289-00	44	tk 71507-00	133
tk 71181-03	210	tk 71280-01	28	tk 71289-02	44	tk 71509-00	133
tk 71181-04	210	tk 71280-03	28	tk 71289-04	44	tk 71510-00	238
tk 71181-05	210	tk 71280-05	28	tk 71289-06	44	tk 71514-00	222
tk 71182-01	212	tk 71280-07	28	tk 71289-08	44	tk 71515-00	238
tk 71182-02	212	tk 71280-09	28	tk 71289-10	44	tk 71515-01	238
tk 71182-03	212	tk 71280-11	28	tk 71290-01	46	tk 71515-02	238
tk 71183-01	213	tk 71280-12	29	tk 71290-02	46	tk 71586-00	134
tk 71183-02	213	tk 71280-13	29	tk 71291-01	48	tk 71923-01	199
tk 71183-03	213	tk 71280-14	29	tk 71291-02	48	tk 71923-02	199
tk 71183-04	213	tk 71280-15	29	tk 71291-03	48	tk 71923-03	199
tk 71183-05	213	tk 71280-17	29	tk 71291-04	49	tk 72180-01	218
tk 71183-06	213	tk 71281-01	30	tk 71291-05	49	tk 72180-02	218
tk 71183-07	213	tk 71281-03	30	tk 71291-06	49	tk 72180-03	218
tk 71183-08	214	tk 71281-05	30	tk 71292-10	53	tk 72180-04	218
tk 71184-01	214	tk 71281-07	30	tk 71292-20	53	tk 72180-05	218
tk 71184-02	214	tk 71281-11	30	tk 71292-30	51	tk 72181-01	219
tk 71184-03	214	tk 71281-12	31	tk 71292-40	51	tk 72181-02	219
tk 71184-04	214	tk 71281-13	31	tk 71292-50	52	tk 72181-03	219
tk 71185-01	120	tk 71281-14	31	tk 71292-60	52	tk 72181-04	219
tk 71185-02	120	tk 71281-15	31	tk 71292-70	52	tk 72182-01	219
tk 71187-01	120	tk 71282-01	32	tk 71306-10	25	tk 72182-02	219
tk 71197-01	121	tk 71282-03	32	tk 71306-20	24	tk 72183-01	219
tk 71197-02	121	tk 71282-05	32	tk 71306-25	24	tk 72183-02	219
tk 71197-03	121	tk 71282-07	32	tk 71306-30	24	tk 72184-01	220

Nummernverzeichnis
Numerical Index

Index numériques

Indice numerico

Indice dei numeri d'articolo

Art. Nr.	Seite	Art. Nr.	Seite	Art. Nr.	Seite	Art. Nr.	Seite
tk 72184-02	220	tk 72504-02	211	tk 73500-10	263	tk 75012-06	249
tk 72185-01	218	tk 72504-03	211	tk 73500-11	264	tk 75013-01	249
tk 72185-02	218	tk 72504-04	211	tk 73500-12	265	tk 75013-02	249
tk 72185-03	218	tk 72504-05	211	tk 73500-13	266	tk 75013-03	249
tk 72185-04	218	tk 72505-01	211	tk 75000-04	245	tk 75013-04	249
tk 72185-05	218	tk 72505-02	211	tk 75000-05	245	tk 79194-03	221
tk 72186-00	220	tk 72505-03	211	tk 75000-06	245	tk 83155-50	214
tk 72186-01	220	tk 72505-04	211	tk 75001-04	245	tk 87001-01	244
tk 72186-02	220	tk 72505-05	211	tk 75001-05	245	tk 87001-02	244
tk 72186-03	220	tk 72506-01	211	tk 75001-06	245	tk 87005-1F-BK	242
tk 72186-04	220	tk 72506-02	211	tk 75002-01	246	tk 87005-1F-BL	242
tk 72187-01	220	tk 72506-03	211	tk 75002-02	246	tk 87005-1F-GR	242
tk 72187-02	220	tk 72506-04	211	tk 75002-03	246	tk 87005-1F-RE	242
tk 72188-01	219	tk 72506-05	211	tk 75002-04	246	tk 87005-1F-SI	242
tk 72188-02	219	tk 72520-00	136	tk 75002-05	246	tk 87005-1F-YE	242
tk 72188-03	219	tk 72521-17	136	tk 75003-03	246	tk 87011-01	243
tk 72188-04	219	tk 73115-18	139	tk 75003-04	246	tk 87018-01	243
tk 72189-01	219	tk 73115-22	139	tk 75004-01	246	tk 87020-02	243
tk 72189-02	219	tk 73116-18	139	tk 75004-02	246	tk 87021-01	243
tk 72189-03	219	tk 73116-22	139	tk 75004-03	246	tk 87021-12	244
tk 72190-01	219	tk 73117-18	139	tk 75006-01	247	tk 87022-02	243
tk 72190-02	219	tk 73117-22	139	tk 75006-02	247	tk 87023-04	243
tk 72190-03	219	tk 73150-00	138	tk 75006-03	247	tk 87025-00	244
tk 72191-01	220	tk 73150-01	138	tk 75006-04	247	tk 87025-01	244
tk 72191-02	220	tk 73361-13	231	tk 75006-05	247	tk 87025-02	244
tk 72191-03	220	tk 73368-01	232	tk 75006-06	247	tk 87025-03	244
tk 72192-00	220	tk 73368-02	232	tk 75007-01	247	tk 87025-04	244
tk 72192-01	220	tk 73378-13	233	tk 75007-02	247	tk 87026-01	243
tk 72192-02	220	tk 73379-12	231	tk 75007-03	247	tk 87026-02	243
tk 72192-03	220	tk 73383-16	235	tk 75007-04	247	tk 87026-03	243
tk 72192-04	220	tk 73384-16	235	tk 75007-05	247	tk 87028-00	244
tk 72193-01	220	tk 73389-13	231	tk 75007-06	247	tk 87029-01	244
tk 72193-02	220	tk 73389-23	231	tk 75008-01	248	tk 87105-1F-BK	242
tk 72193-03	220	tk 73390-13	235	tk 75008-02	248	tk 87105-1F-BL	242
tk 72194-01	221	tk 73390-33	233	tk 75008-03	248	tk 87105-1F-GR	242
tk 72194-02	221	tk 73391-01	235	tk 75008-04	248	tk 87105-1F-RE	242
tk 72194-04	221	tk 73391-14	235	tk 75008-05	248	tk 87105-1F-SI	242
tk 72195-01	221	tk 73394-13	234	tk 75008-06	248	tk 87105-1F-YE	242
tk 72195-02	221	tk 73395-00	237	tk 75009-01	248	tk 87115-1F-BK	242
tk 72195-03	221	tk 73395-13	234	tk 75009-02	248	tk 87115-1F-BL	242
tk 72196-11	221	tk 73396-00	237	tk 75009-03	248	tk 87115-1F-GR	242
tk 72196-13	221	tk 73397-00	237	tk 75009-04	248	tk 87115-1F-RE	242
tk 72500-00	202, 211	tk 73398-00	237	tk 75009-05	248	tk 87115-1F-SI	242
tk 72501-01	211	tk 73400-01	230	tk 75009-06	248	tk 87115-1F-YE	242
tk 72501-02	211	tk 73400-03	230	tk 75010-01	248	tk 95000-00	250
tk 72501-03	211	tk 73400-07	230	tk 75010-02	248	tk 95100-00	250
tk 72501-04	211	tk 73400-09	230	tk 75010-03	248		
tk 72501-05	211	tk 73410-12	239	tk 75010-04	248		
tk 72502-01	211	tk 73412-12	239	tk 75011-01	249		
tk 72502-02	211	tk 73415-12	236	tk 75011-02	249		
tk 72502-03	211	tk 73500-01	254	tk 75011-03	249		
tk 72502-04	211	tk 73500-02	255	tk 75011-04	249		
tk 72502-05	211	tk 73500-03	256	tk 75011-05	249		
tk 72503-01	211	tk 73500-04	257	tk 75011-06	249		
tk 72503-02	211	tk 73500-05	258	tk 75012-01	249		
tk 72503-03	211	tk 73500-06	259	tk 75012-02	249		
tk 72503-04	211	tk 73500-07	260	tk 75012-03	249		
tk 72503-05	211	tk 73500-08	261	tk 75012-04	249		
tk 72504-01	211	tk 73500-09	262	tk 75012-05	249		

Inhaltsverzeichnis	Table des matières
<i>Index</i>	<i>Indice</i>
	Indice

Inhaltsverzeichnis
Index

Table des matières
Indice
Indice

A

Abdrucklöffel 218-221
 Absauger, chirurgisch..... 137
 ADSON BROWN, Anatomische Pinzetten - Chirurgische Pinzetten ... 157
 ADSON, Anatomische Pinzetten - Chirurgische Pinzetten..... 157-158
 ADSON, Raspatorien - Elevatorien..... 193
 ADSON-GRAEFE, Anatomische Pinzetten - Chirurgische Pinzetten... 157
 AINSWORTH, Rubber Dam Instrumente 133
 ALLIS, Gewebefasszangen 166
 ALLIS-ADAIR, Gewebefasszangen 166
 ALLIS-BABY, Gewebefasszangen 166
 Amalgampistolen 120
 ANGLE (TWEED), Orthodontiezangen 231
 APICAL, Wurzelheber 76
 ARKANSAS, Schleifsteine..... 44
 Arterienklemmen 163-165
 Artikulationspinzette 136
 ASH, Instrumente für plastische Füllungen 125
 AUTOMATIC, Kroneninstrumente..... 224

B

BABY-CRILE-WOOD, Nadelhalter 182
 BACKHAUS, Tuchklemmen..... 167
 BARNHART, Instrumente zur Paradontologie..... 35
 BARRAQUER, Mikronadelhalter mit Rundgriff..... 190
 BARRY,Wurzelheber 79
 BEEBEE, Kronenscheren..... 155, 225
 BEIN, Wurzelheber 66
 BERNARD, Wurzelheber 73-74
 BLACK, Instrumente für plastische Füllungen..... 129 / 132
 BLUMENTHAL, Hohlmeißelzangen..... 205
 BÖHLER, Hohlmeißelzangen / Knochensplitterzangen..... 207
 Bone Pusher..... 211
 Bracket-Faß-Pinzetten 230
 BREWER, Rubber Dam Instrumente..... 133
 BROPHY (SULLIVAN), Chirurgische Scheren 148
 BRUENINGS, Zungenspatel 179
 BUSER, Knochenentnahme und -applikation 212, 214
 BUSER, Raspatorien für die Kieferchirurgie 196

C

CAEWOOD-MINNESOTA, Wangenhalter 178
 CASTROVIEJO- JACOBSON, Nadelhalter 189
 CASTROVIEJO, Messinstrumente..... 136
 CASTROVIEJO, Mikroscheren mit Rundgriff..... 152
 CASTROVIEJO, Rasierklingenthaler und -brecher..... 143
 CATTONI, Zahnreiniger 39
 CHOMPRET, Syndesmotome 83
 CHOMPRET, Wurzelschrauben 83
 CLEOID-DISCOLD, Instrumente für plastische Füllungen 131
 CLEVELAND, Hohlmeißelzangen 206
 COLLEGE MODIF., Zahnpinzetten 20
 COLLIN, Hämmer 201
 COLUMBIA, Instrumente zur Paradontologie..... 26
 Container und Zubehör für Dental..... 242-249
 COTTLE, Hämmer..... 200
 COTTLE, Knochenmühle..... 215
 COTTLE, Wundhaken 172
 CRANE-KAPLAN, Zahnreiniger - Sichelreiniger 42
 CRANE-KAPLAN, Zahntaschen-Markierpinzetten 47

CRILE, Arterienklemmen 164
 CRILE-MURRAY, Nadelhalter 181
 CRILE-RANKIN, Arterienklemmen 164
 CRILE-WOOD, Nadelhalter 181
 CROWN SCISSORS, Kronenscheren..... 154
 CRYER, Wurzelheber 76
 CUSHING, Pinzetten, anatomisch..... 156
 CUSHING, Pinzetten, anatomisch & chirurgisch 160

D

DARBY-PERRY, Zahnreiniger 39
 DE BAKEY BAYONET, Pinzetten, atraumatisch 162
 DE BAKEY, Nadelhalter..... 188
 DE BAKEY, Pinzetten, atraumatisch..... 162
 DE BAKEY-GERALD, Pinzetten, atraumatisch..... 162
 DEAN, Scheren, chirurgisch 154
 DENHART, Mundsperrerr 168-169
 DEPPELER, Zahnreiniger - Sichelreiniger 42
 DERF, Nadelhalter 181
 DESMARRES, Wundhaken 170
 Doppellöffel, scharf..... 191-192
 Drahtschneidezangen 239

E

EMOS, Zungenspatel..... 179
 Endodontie-Pinzetten 58
 Exkavatoren 118-119

F

FAHNENSTOCK, Wachsmesser..... 222
 FARABEUF, Wundhaken..... 177
 FERGUSSON-ACKLAND, Mundsperrerr 168
 FLAGG, Zahnpinzetten 19
 FOSTER-GILLIES, Nadelhalter..... 186
 FRAHM, Instrumente für plastische Füllungen..... 131
 FREER, Knochenmeißel 203
 FREER, Raspatorien für die Kieferchirurgie 195
 FRIEDMANN, Hohlmeißelzangen 205
 FRIEDMANN, Wurzelheber 77
 FURRER, Kroneninstrumente 224

G

GÄRTNER, Wurzelheber..... 68-69
 Gewebefasszangen 166
 GILLIES, Nadelhalter 185-186
 Gingivektomiemesser..... 46
 GLICKMANN, Raspatorien für die Kieferchirurgie 195
 GOLDMAN-FOX, Instrumente zur Paradontologie..... 34
 GOLDMAN-FOX, Scheren für plastische Operationen..... 151
 GOLDMAN-FOX, Zahnreiniger - Sichelreiniger 43
 GRACEY LARGE, Instrumente zur Paradontologie..... 27, 30, 31
 GRACEY SMALL, Instrumente zur Paradontologie 27, 32, 33
 GRACEY STANDARD, Instrumente zur Paradontologie..... 27, 28, 29
 GRAEFE, Pinzetten, anatomisch & chirurgisch..... 159
 GROSS-MAIER, Tuchklemmen 167

H

HALSEY, Nadelhalter 183
 HALSTED- MOSQUITO, Arterienklemmen..... 163
 HALSTED- MOSQUITO, Orthodontiezangen..... 233

Inhaltsverzeichnis Index

Table des matières Indice Indice

Hämmer.....	200-201
HARTMANN, Arterienklemmen	163
HEGAR-BAUMGARTNER, Nadelhalter	182
HEIDBRINK, Wurzelheber	81-82
HEIDEMANN, Instrumente für plastische Füllungen	124, 130
HEMINGWAY, Scharfe Doppellöffel	192
HENAHAN, Zahnzangen, amerikanische Form.....	106
HIRSCHFELD, Parodontalfeilen	49
HIRSCHFELD, Raspatorien für die Kieferchirurgie	195
Hohlmeißelzangen.....	205-207
HOLLENBACK, Instrumente für Amalgam, Guttapercha und Zement	121
HOLLENBECK, Instrumente für plastische Füllungen.....	131
HÖSEL, Nadelhalter	185
HOW, Orthodontiezangen.....	232
HYGIENIST, Zahnreiniger - Sichelreiniger.....	40
HYGIENIST-TOWNER, Zahnreiniger - Sichelreiniger.....	40
HYLIN, Wurzelheber	78

I

INDIA, Schleifsteine	44
INDIANA UNIVERSITY, Instrumente zur Parodontologie.....	35
Instrumente für Amalgam, Guttapercha und Zement	121
Instrumente für plastische Füllungen	123-132
Instrumente zur Parodontologie	26-37
IVORY, Rubber Dam Instrumente.....	133

J

JAQUETTE, Zahnreiniger - Sichelreiniger.....	41
JAVANOVIC, Knochenentnahme und -applikation	213

K

Kanülen.....	138
KELLY, Arterienklemmen	164
KELLY, Scheren, chirurgisch	146
KELLY-RANKIN, Arterienklemmen	164
KHOURY, Raspatorien für die Kieferchirurgie	196
KILNER, Nadelhalter.....	187
KILNER, Wundhaken.....	172
Kinderzahnzangen, englische Form	102-105
KIRKLAND, Gingivektomiemesser	46
KIRKLAND, Parodontal Meißel	52
KLEIN, Kinderzahnzangen, englische Form.....	104
Knochenentnahme und -applikation.....	212-214
Knochenfeilen	199
Knochenküretten	197-198
Knochenmeißel	202-204
Knochenmühle	215
Knochensplitterzangen.....	207
KOCHER, Arterienklemmen	165
KOCHER-LANGENBECK (OBWEGESER), Wundhaken	174
KOPP, Wurzelheber.....	67
KRAMER-NEVINS, Knochenmeißel	203
KROENIG, Zungenspatel.....	179
Kroneninstrumente	224-227
Kronenscheren.....	154-155
Küretten, chirurgisch.....	50

L

LANGENBECK, Wundhaken	174
LANGER, Instrumente zur Parodontologie	37

LECLUSE, Wurzelheber	78
LICHTENBERG, Nadelhalter	185
Ligaturenverstecker	237
LINDO-LEVIN, Wurzelheber	70
LISTER, Verbandscheren	155
LISTON, Hohlmeißelzangen / Knochensplitterzangen	207
LOCKLIN, Scheren, fein	150
LONDON COLLEGE, Endodontie-Pinzetten	58
LONDON COLLEGE, Zahnpinzetten	20
LUCAS, Knochenküretten	197
LUER, Hohlmeißelzangen	206
LUNIATSCHEK, Tamponstopfer.....	223

M

MAC FARLANE, Zahnreiniger - Sichelreiniger	43
MANNERFELT MODIF., Knochenmeißel	203
MARTINI, Doppellöffel, scharf.....	191
MATHIEU, Nadelhalter.....	184
MATHIEU, Orthodontiezangen.....	232
MATHIEU-OLSEN, Nadelhalter.....	182-183
Matrizenspanner	134
MAYO-HEGAR, Nadelhalter.....	184
MAZOUCH, DR., Kroneninstrumente	225
MC CALL, Instrumente zur Parodontologie.....	36
MC CALL, Zahnreiniger	38
MC KELLOPS, Orthodontiezangen.....	235
MEAD, Hämmer	201
MEAD, Hohlmeißelzangen	206
MEAD, Kinderzahnzangen, englische Form	105
MERIAM, Zahnpinzetten	18
MERSHON, Orthodontie Instrumente.....	238
Messinstrumente	136, 222
METZENBAUM, Scheren, chirurgisch	146-147
MICRO-ADSON, Pinzetten, anatomisch - Pinzetten, chirurgisch	157-158
MICRO-MOSQUITO, Arterienklemmen.....	163
Micro-Resektionsspiegel	56
MIDDELDORPF, Wundhaken.....	171
Mikroklingen	140
Mikroklingenthalter	140
Mikronadelhalter mit Rundgriff	190
Mikro-Pinzetten.....	161
Mikroscheren	153
Mikroscheren mit Rundgriff	152
MILLER, Artikulationspinzette	136
MILLER, Knochenfeilen	199
MILLER, Wurzelheber	77
MILLER-COLBURN, Knochenfeilen	199
MILLER-COLBURN, Knochenküretten	197-198
MINI- FRIEDMANN, Hohlmeißelzangen.....	205
MINI-LAMBOTTE, Knochenmeißel.....	204
MINI-LANGENBECK, Wundhaken.....	171
MOD. «PLASTIC», Instrumente für plastische Füllungen	123
MOLT , Raspatorien für die Kieferchirurgie	195-196
MOLT MOD., Mundsperrerr	169
MOLT, Knochenküretten	198
MOLT, Mundsperrerr	168
MORRISON, Syndesmotome	83
Mundsperrerr	168-169
Mundspiegel und -griffe	16-17
Mundspiegelgriffe	56

Inhaltsverzeichnis
Index

Table des matières
Indice
Indice

Deutsch

N	
Nadelhalter	181-189
NEIVERT, Nadelhalter	187
NEUMANN, Feine Scheren	150
NEVIUS, Zahnzangen, amerikanische Form	111
NOYES, Zahnfleischschere	153
O	
O'BRIAN, Orthodontiezangen	235
OBWEGESER, Raspatorien für die Kieferchirurgie	194
OBWEGESER, Weichteilhaken für die Kieferchirurgie	175-176
OBWEGESER-FREER, Raspatorien für die Kieferchirurgie	194
OCHSENBEIN, Parodontal Meißel	51-53
OLSEN-HEGAR, Nadelhalter	183
ORBAN, Gingivektomiemesser	46
Orthodontieinstrumente	229-238
Orthodontiezangen	231-236
Osteotome	211
P	
Parodontalfeilen	48-49
Parodontometer	24-25
PARMLY, Zahnzangen, amerikanische Form	109
Parodontal Meißel	51-53
PÉAN, Arterienklemmen	165
PECK-JOSEF, Chirurgische Scheren	148
PEET, Wurzelsplitterzangen	59
Periotome, doppelendig	65
Periotome, einendig	64
PERRY, Zahnpinzetten	19
Pflegemittel - Spezial Ölspray	250
PHYSIK, Zahnzangen, amerikanische Form	106
Pinzetten, anatomisch	156
Pinzetten, atraumatisch	162
Pinzetten, chirurgisch	157-160
PRICHARD, Chirurgische Küretten	50
PRICHARD, Raspatorien für die Kieferchirurgie	195
Q	
QUINBY, Feine Scheren	150
R	
RAGNELL- DAVIS, Wundhaken	173
RALK, Wurzelsplitterzangen	59
Rasierklingenthaler und -brecher	143
Raspatorien - Elevatorien	193
Raspatorien für die Kieferchirurgie	194-196
RHODES, Parodontal Meißel	52
ROSER-KÖNIG, Mundsperrerr	168
Rubber Dam Instrumente	133-134
S	
Scheren für plastische Operationen	151
Scheren für Zahnfleisch	149
Scheren, chirurgisch	146-148, 154-155
Scheren, fein	150
SCHUEFELE, Abdrucklöffel	221
Schleifsteine	44
SCHLUGER, Parodontalfeilen	48
SEBILÉAU, Raspatorien für die Kieferchirurgie	194

SELDIN, Wurzelheber	76
SEMKEN, anatomische & chirurgische Pinzetten	160
SEMKEN, anatomische Pinzetten	156
SENN-GREEN, Wundhaken	173
SENN-MILLER, Wundhaken	172
SHEEHAN, Knochenmeißel	204
Sinus-lift-Curette	209
Sinus-lift-Instrumente	209-210
Skalpellgriffe	141
Skalpellklingen	142
SPECIAL, Instrumente zur Parodontologie	36
SPENCER, Scheren für plastische Operationen	151
SPRENGEL, Instrumente für plastische Füllungen	131
Spritzen	138-139
STANDARD, Chirurgische Scheren	147
STANDARD, Skalpellgriffe	141
STANDARD, Zahnzangen, amerikanische Form	106
STEIGMANN, Knochenentnahme und -applikation	213
STERNBERG, Wangenhalter	178
STIEGLITZ, Wurzelsplitterzangen	59
STILLE, Anatomische Pinzetten	156
SUGERMAN, Parodontalfeilen	48
Syndesmotome	83
T	
Tamponstopfer	223
TOFFLEMIRE, Matrizenspanner	134
TOMATI, Zahnfleischklappenstanzen	208
TOWNER-JAQUETTE, Sichelreiniger	40
TROUTMAN- CHRIS, Rasierklingenthaler und -brecher	143
Tuchklemmen	167
TWEED LOOP, Orthodontiezangen	235
TWEED STANDARD, Orthodontiezangen	233
U	
ULTRA-MICRO-ADSON, Pinzetten, anatomisch & chirurgisch	158
UNIVERSAL, Orthodontiezangen	235
UNIVERSAL, Scheren, chirurgisch	154
USA, Instrumente für Amalgam, Guttapercha und Zement	121
V	
VANNAS, Mikroscheren mit Rundgriff	152
VASCULAR, Nadelhalter	187
W	
Wachsmesser	222
WACHTEL, Raspatorien für die Kieferchirurgie	196
Wangenhalter	178
WARD, Instrumente für Amalgam, Guttapercha und Zement	121
WEBSTER, Nadelhalter	182
Weichteilhaken für die Kieferchirurgie	175-176
WEIL-BLAKESLEY, Zahnfleischklappenstanzen	208
WEINGART, Orthodontiezangen	231
Weisheitszahnzangen	99
WESTCOTT, Instrumente für plastische Füllungen	132
WESTCOTT, Mikroscheren	153
WHITE, Exkavatoren	118
WHITE, Instrumente für plastische Füllungen	132
WHITE, Zahnzangen, englische Form	100
WIEDER, Zungendrucker	178

Inhaltsverzeichnis Index

Table des matières
Indice
Indice

WILLIAMS, Gewebefasszangen	166
WILLIGER, Doppellöffel, scharf	191
WILLIGER, Raspatorien – Elevatorien	193
WINTER, Wurzelheber	80
WITZEL, Wurzelsplitterzangen	60
Wundhaken	170-174, 177
Wurzelheber	66-82
Wurzelschrauben	83
Wurzelsplitterzangen.....	59-60
WYNNMANN, Kroneninstrumente.....	225

Y

YOUNG, Orthodontiezangen.....	233
YOUNG, Zungenzangen	178
YOUNGER-GOOD, Instrumente zur Parodontologie	36

Z

Zahnfleischklappenstanzen	208
Zahnfleischmesser	144
Zahnpinzetten	18-20
Zahnreiniger	38-39
Zahnreiniger - Sichelreiniger	40-43
Zahnsonden	21-22
Zahnsonden, einendig.....	57
Zahntaschen-Markierpinzetten.....	47
Zahnzangen, amerikanische Form	106-115
Zahnzangen, englische Form	85-101
Zangen für Nervnadeln.....	61
Zementkratzer	237
Zementspatel	122
Zungendrücker	178
Zungenspatel	179
Zungenzangen.....	178

Inhaltsverzeichnis
Index

Table des matières
Indice
Indice

English

A

ADSON BROWN, dressing forceps - tissue forceps 157

ADSON, dressing forceps - tissue forceps..... 157-158

ADSON, raspatory - elevators 193

ADSON-GRAEFE, dressing forceps - tissue forceps 157

AINSWORTH, rubber dam instruments 133

ALLIS, tissue holding forceps 166

ALLIS-ADAIR, tissue holding forceps 166

ALLIS-BABY, tissue holding forceps..... 166

Amalgam carriers..... 120

ANGLE (TWEED), orthodontic forceps 231

APICAL, root elevators 76

ARKANSAS, grinding stones..... 44

Articulating tweezers 136

ASH, plastic filling instruments 125

AUTOMATIC, instruments for crown work 224

B

BABY-CRILE-WOOD, needle holders 182

BACKHAUS, towel forceps 167

BARNHART, periodontal instruments 35

BARRAQUER, micro needle holders with round handle 190

BARRY, root elevators 79

BEEBEE, crown scissors 155, 225

BEIN, root elevators 66

BERNARD, root elevators 73-74

BLACK, plastic filling instruments 129 / 132

BLUMENTHAL, bone rongeurs..... 205

BÖHLER, bone rongeurs / bone cutting forceps 207

Bone chisels..... 202-204

Bone craft and -application 212-214

Bone curettes 197-198

Bone cutting forceps..... 207

Bone files 199

Bone mills 215

Bone pusher..... 211

Bone rongeurs..... 205-207

Bracket forceps..... 230

BREWER, rubber dam instruments 133

BROPHY (SULLIVAN), tissue forceps 148

BRUENINGS, tongue depressors 179

BUSER, bone craft and -application 212, 214

BUSER, raspatory for maxillary surgery..... 196

C

CAEWOOD-MINNESOTA, cheek retractors 178

Cannulas..... 138

Care products - instrument milk 251

Care products - special oilspray 250

CASTROVIEJO, calipers 136

CASTROVIEJO, micro scissors with round handle 152

CASTROVIEJO, razor blade holders and -breakers 143

CASTROVIEJO-JACOBSON, needle holders 189

CATTONI, scalers..... 39

Cement spatulas 122

Cheek retractors 178

CHOMPERT, root screws 83

CHOMPERT, syndesmotomes..... 83

CLEOID-DISCOLD, plastic filling instruments 131

CLEVELAND, bone rongeurs 206

COLLEGE MODIF., tweezers 20

COLLIN, mallets 201

COLUMBIA, periodontal instruments 26

Containers and accessories for dental 242-249

COTTLE, bone mills 215

COTTLE, mallets..... 200

COTTLE, retractors..... 172

CRANE-KAPLAN, dental pocket marker tweezers 47

CRANE-KAPLAN, scalers - sickle scalers 42

CRILE, haemostatic forceps 164

CRILE-MURRAY, needle holders 181

CRILE-RANKIN, haemostatic forceps..... 164

CRILE-WOOD, needle holders 181

Crown instruments..... 224-227

Crown scissors 154-155

CROWN SCISSORS, crown scissors 154

CRYER, root elevators 76

Curettes, surgical..... 50

CUSHING, forceps, dressing 156

CUSHING, forceps, dressing & tissue..... 160

D

DARBY-PERRY, scalers 39

DE BAKEY BAYONET, forceps, atraumatic..... 162

DE BAKEY, forceps, atraumatic 162

DE BAKEY, needle holders..... 188

DE BAKEY-GERALD, forceps, atraumatic 162

DEAN, scissors, operating..... 154

DENHART, mouth gags..... 168-169

Dental pocket marker tweezers..... 47

DEPPELER, scalers, sickle scalers..... 42

DERF, needle holders 181

DESMARRES, retractors..... 170

Double spoon, sharp 191-192

E

EMOS, tongue depressors..... 179

Endodontic-tweezers..... 58

Excavators 118-119

F

FAHNENSTOCK, modelling carvers 222

FARABEUF, retractors 177

FERGUSSON-ACKLAND, mouth gags 168

FLAGG, tweezers..... 19

Forceps for nerve broach 61

Forceps, atraumatic 162

Forceps, dressing 156

Forceps, tissue..... 157-160

FOSTER-GILLIES, needle holders..... 186

FRAHM, plastic filling instruments 131

FREER, bone chisels..... 203

FREER, raspatory for maxillary surgery 195

FRIEDMANN, bone rongeurs 205

FRIEDMANN, root elevators 77

FURRER, crown instruments 224

G

GÄRTNER, root elevators..... 68-69

Gauze packers 223

Inhaltsverzeichnis Index

Table des matières Indice Indice

GILLIES, needle holder.....	185-186
Gingivectomy knives.....	46
GLICKMANN, raspatory for maxillary surgery.....	195
GOLDMAN-FOX, periodontal instruments.....	34
GOLDMAN-FOX, scalers - sickle scalers.....	43
GOLDMAN-FOX, scissors for plastic surgery.....	151
GRACEY LARGE, periodontal instruments.....	27, 30, 31
GRACEY SMALL, periodontal instruments.....	27, 32, 33
GRACEY STANDARD, periodontal instruments.....	27, 28, 29
GRAEFE, forceps, dressing & tissue.....	159
Grinding stones.....	44
GROSS-MAIER, towel clamps.....	167
Gum guillotine forceps.....	208
Gum knives.....	144
Gum scissors.....	149

H

Haemostatic forceps.....	163-165
HALSEY, needle holders.....	183
HALSTED-MOSQUITO, haemostatic forceps.....	163
HALSTED-MOSQUITO, orthodontic forceps.....	233
HARTMANN, haemostatic forceps.....	163
HEGAR-BAUMGARTNER, needle holders.....	182
HEIDBRINK, root elevators.....	81-82
HEIDEMANN, plastic filling instruments.....	124, 130
HEMINGWAY, double spoon, sharp.....	192
HENAHAN, extracting forceps, american pattern.....	106
HIRSCHFELD, periodontal files.....	49
HIRSCHFELD, raspatory for maxillary surgery.....	195
HOLLENBACK, instruments for amalgam, gutta-percha and cement.....	121
HOLLENBECK, plastic filling instruments.....	131
HÖSEL, needle holders.....	185
HOW, orthodontic forceps.....	232
HYGIENIST, sclaers - sickle scalers.....	40
HYGIENIST-TOWNER, scalers - sickle scalers.....	40
HYLIN, root elevators.....	78

I

Impression trays.....	218-221
INDIA UNIVERSITY, periodontal instruments.....	35
INDIA, grinding stones.....	44
Instruments for amalgam, gutta-percha and cement.....	121

J

JAQUETTE, scalers - sickle scalers.....	41
JAVANOVIC, bone craft and -application.....	213

K

KELLY, haemostatic forceps.....	164
KELLY, scissors, operating.....	146
KELLY-RANKIN, haemostatic forceps.....	164
KHOURY, raspatory for maxillary surgery.....	196
KILNER, needle holders.....	187
KILNER, retractors.....	172
KIRKLAND, gingivectomy knives.....	46
KIRKLAND, periodontal chisel.....	52
KLEIN, tooth extracting forceps for children, english pattern.....	104
KOCHER, haemostatic forceps.....	165
KOCHER-LANGENBECK (OBWEGESER), retractors.....	174
KOPP, root elevators.....	67

KRAMER-NEVINS, bone chisels.....	203
KROENIG, tongue depressor.....	179

L

LANGENBECK, retractors.....	174
LANGER, periodontal instruments.....	37
LECLUSE, root elevators.....	78
LICHTENBERGER, needle holders.....	185
Ligatures passers.....	237
LINDO-LEVIN, root elevators.....	70
LISTER, bandage scissors.....	155
LISTON, bone rongeurs / bone cutting forceps.....	207
LOCKLIN, scissors, fine.....	150
LONDON COLLEGE, endodontic tweezers.....	58
LONDON COLLEGE, tweezers.....	20
LUCAS, bone curettes.....	197
LUER, bone rongeurs.....	206
LUNIATSCHEK, gauze packers.....	223

M

MAC FARLANE, scalers - sickle scalers.....	43
Mallets.....	200-201
MANNERFELT MODIF., bone chisels.....	203
MARTINI, double scoops, sharps.....	191
MATHIEU, needle holders.....	184
MATHIEU, orthodontic forceps.....	232
MATHIEU-OLSEN, needle holders.....	182-183
Matrix retainers.....	134
MAYO-HEGAR, needle holders.....	184
MAZOUCH, DR., crown instruments.....	225
MC CALL, periodontal instruments.....	36
MC CALL, scalers.....	38
MC KELLOPS, orthodontic forceps.....	235
MEAD, bone rongeurs.....	206
MEAD, mallets.....	201
MEAD, tooth extracting forceps for children, english pattern.....	105
Measuring instruments.....	136, 222
MERIAM, tweezers.....	18
MERSHON, orthodontic instruments.....	238
METZENBAUM, Scissors, operating.....	146-147
Micro forceps.....	161
Micro needle holders with round handle.....	190
Micro resection mirrors.....	56
Micro scissors.....	153
Micro scissors with round handle.....	152
MICRO-ADSON, forceps, dressing - forceps, tissue.....	157-158
Micro-blade holders.....	140
Micro-blades.....	140
MICRO-MOSQUITO, haemostatic forceps.....	163
MIDDELDORPF, retractors.....	171
MILLER, articulating forceps.....	136
MILLER, bone files.....	199
MILLER, root elevators.....	77
MILLER-COLBURN, bone curettes.....	197-198
MILLER-COLBURN, bone files.....	199
MINI-FRIEDMANN, bone rongeurs.....	205
MINI-LAMBOTTE, bone chisels.....	204
MINI-LANGENBECK, retractors.....	171
MOD. «PLASTIC», plastic filling instruments.....	123
MOLT MOD., mouth gags.....	169

Inhaltsverzeichnis
Index

Table des matières
Indice
Indice

MOLT, bone curettes 198
MOLT, mouth gags 168
MOLT, raspatory for maxillary surgery 195-196
MORRISON, syndesmotomes 83
Mouth gags 168-169
Mouth mirrors and handles 16-17
Mouth mirrors handles 56

N
Needle holders 181-189
NEIVERT, needle holders 187
NEUMANN, fine scissors 150
NEVIUS, tooth extracting forceps, american pattern 111
NOYES, gum scissors 153

O
O'BRIAN, orthodontic forceps 235
OBWEGESER, raspatory for maxillary surgery 194
OBWEGESER, soft tissue retractors for maxillary surgery 175-176
OBWEGESER-FREER, raspatory for maxillary surgery 194
OCHSENBEIN, periodontal chisel 51-53
OLSEN-HEGAR, needle holders 183
ORBAN, gingivectomy knives 46
Orthodontic forceps 231-236
Orthodontic instruments 229-238
Osteotomes 211

P
PARMLY, tooth extracting forceps, american forceps 109
PÉAN, haemostatic forceps 165
PECK-JOSEF, operating scissors 148
PEET, root splinter forceps 59
Peridontometer 24-25
Periodontal chisels 51-53
Periodontal files 48-49
Periodontal instruments 26-37
Periotomes, double ended 65
Periotomes, single ended 64
PERRY, tweezers 19
PHYSIK, tooth extracting forceps, american pattern 106
Plastic filling instruments 123-132
PRICHARD, raspatory for maxillary surgery 195
PRICHARD, surgical curettes 50
Probes 21-22
Probes, single ended 57

Q
QUINBY, fine scissors 150

R
RAGNELL-DAVIS, retractors 173
RALK, root splinter forceps 59
Raspatory - elevators 193
Raspatory for maxillary surgery 194-196
Razer blade holders and -breakers 143
Retractors 170-174, 177
RHODES, periodontal chisels 52
Root elevators 66-82
Root screws 83
Root splinter forceps 59-60

ROSER-KÖNIG, mouth gags 168
Rubber dam instruments 133-134

S
Scalers 38-39
Scalers - sickle scalers 40-43
Scalpel blades 142
Scalpel handles 141
SCHEUFLE, impression trays 221
SCHLUGER, periodontal files 48
Scissors for plastic surgery 151
Scissors, fine 150
Scissors, surgical 146-148, 154-155
SEBILEAU, raspatory for maxillary surgery 194
SELDIN, root elevators 76
SEMKEN, dressing & tissue forceps 160
SEMKEN, dressing forceps 156
SENN-GREEN, retractors 173
SENN-MILLER, retractors 172
SHEEHAN, bone chisels 204
Sinus-lift curettes 209
Sinus-lift instruments 209-210
Soft tissue retractors for maxillary surgery 175-176
SPECIAL, periodontal instruments 36
SPENCER, scissors for plastic surgery 151
SPRENGEL, plastic filling instruments 131
STANDARD, operating scissors 147
STANDARD, scalpel handles 141
STANDARD, tooth extracting forceps, american pattern 106
STEIGMANN, bone craft and -application 213
STERNBERG, cheek retractors 178
STIEGLITZ, root splinter forceps 59
STILLE, dressing forceps 156
Suction tubes 137
SUGERMAN, periodontal files 48
Syndesmotomes 83
Syringes 138-139

T
Tissue grasping forceps 166
TOFFLEMIRE, matrix retainers 134
TOMATI, gum guillotine forceps 208
Tongue depressors 178, 179
Tongue holding forceps 178
Tooth extracting forceps, american pattern 102-105
Tooth extracting forceps, american pattern 106-115
Tooth extracting forceps, english pattern 85-101
Towel forceps 167
TOWNER-JAQUETTE, sickle scalers 40
TROUTMAN-CHRIS, razor baldes holders and -breakers 143
TWEED LOOP, orthodontic forceps 235
TWEED STANDARD, orthodontic forceps 233
Tweezers 18-20

U
ULTRA-MICRO-ADSON (BRAKA), forceps, dressing & tissue 158
UNIVERSAL, orthodontic forceps 235
UNIVERSAL, scissors, operating 154
USA, instruments for amalgam, gutta-percha and cement 121
Utility-instruments 237

Inhaltsverzeichnis
Index

Table des matières
Indice
Indice

V

VANNES, micro scissors with round handle	152
VASCULAR, needle holders	187

W

WACHTEL, raspatory for maxillary surgery	196
WARD, instruments for amalgam, gutta-percha and cement	121
Wax knives	222
WEBSTER, needle holders	182
WEIL-BLAKESLEY, gum guillotine forceps	208
WEINGART, orthodontic pliers	231
WESTCOTT, plastic filling instruments	132
WESTCOTT, micro scissors	153
WHITE, excavators	118
WHITE, plastic filling instruments	132
WHITE, tooth extracting forceps, english pattern	100
WIEDER, tongue depressor	178
WILLIAMS, tissue grasping forceps	166
WILLIGER, double spoon, sharp	191
WILLIGER, raspatory - elevators	193
WINTER, root elevators	80
Wire cutting forceps	239
Wisdom tooth extracting forceps	99
WITZEL, root splinter forceps	60
WYNNMANN, crown instruments	225

Y

YOUNG, orthodontic forceps	233
YOUNG, tongue holding forceps	178
YOUNGER-GOOD, periodontal instruments	36

Inhaltsverzeichnis
Index

Table des matières
Indice
Indice

A

Abaisses-langues 178

Abaisses-langues 179

ADSON - pinces à dissection à griffes 157-158

ADSON BROWN - pinces à dissection 157

ADSON RUGINES - élévateurs 193

ADSON-GRAEFE, pinces à dissection - pinces à dissection à griffes 157

AINSWORTH, instruments Rubber Dam 133

ALLIS, pinces de tissu 166

ALLIS-ADAIR, pinces de tissu 166

ALLIS-BABY, pinces de tissu 166

ANGLE (TWEED), pinces pour l'orthodontie 231

APICAL, élévateurs à racines 76

ARKANSAS, pierres d'affûtage 44

ASH, instruments pour plombages plastiques 125

AUTOMATIC, instruments pour couronnes 224

B

BABY-CRILE-WOOD, portes-aiguille 182

BACKHAUS, pinces à champs 167

BARNHART, instruments pour la parodontologie 35

BARRAQUER, micro portes-aiguilles avec manche ronde 190

BARRY, élévateurs à racines 79

BEEBEE, ciseaux pour couronne 155, 225

BEIN, élévateurs à racines 66

BERNARD, élévateurs à racines 73-74

Bistouri à gencives 144

Bistouris pour la gingivectomie 46

BLACK, instruments pour plombages plastiques 129 / 132

BLUMENTHAL, pinces gouges 205

BÖHLER, pincettes gouges / pinces coupantes à os 207

Bone pusher 211

BREWER, instruments Rubber Dam 133

BROPHY (SULLIVAN), ciseaux à chirurgie 148

Broyeurs d'os 215

BRUENINGS, abaisse-langues 179

BUSER, prélèvement et application de matériel d'os 212, 214

BUSER, prélèvement et application de matériel d'os 212-214

BUSER, Rugines-Décolleurs pour la chirurgie maxillo-faciale 196

C

CAEWOOD-MINNESOTA, écarteurs des joues 178

Cannules d'aspiration 137

Canules 138

CASTROVIEJO- JACOBSON, portes-aiguilles 189

CASTROVIEJO, instruments pour mesurer 136

CASTROVIEJO, micro ciseaux avec manche ronde 152

CASTROVIEJO, porte-lames et brise lames de rasoir 143

CATTONI, instruments à détartrer 39

CHOMPRET, syndesmotomes 83

CHOMPRET, vis à racines 83

Ciseaux à chirurgie 146-148, 154-155

Ciseaux fins 150

Ciseaux parodontaux 51-53

ciseaux pour couronnes 154-155

ciseaux pour couronnes 154

Ciseaux pour la chirurgie plastique 151

Ciseaux pour la gencive 149

Ciseaux-burins, gouges 202-204

CLEOID-DISCOLD, instruments pour plombages plastiques 131

CLEVELAND, pinces gouges 206

COLLEGE MODIF 20

COLLIN, maillets 201

COLUMBIA, instruments pour la parodontologie 26

Contenaires dentaires et accessoires 242-249

COTTLE, broyeurs d'os 215

COTTLE, écarteurs 172

COTTLE, maillets 200

Couteaux à cire 222

CRANE-KAPLAN, instruments à détartrer - détartrés faucilles 42

CRANE-KAPLAN, pinces à marquer les poches périodontales 47

CRILE, pinces hémostatiques 164

CRILE-MURRAY, portes-aiguilles 181

CRILE-RANKIN, pinces hémostatiques 164

CRILE-WOOD, portes-aiguilles 181

CRYER, élévateurs à racines 76

Curettes à os 197-198

Curettes chirurgicales 50

Curettes doubles 191-192

Curettes Sinus-lift 209

CUSHING, pinces à dissection 156

CUSHING, pinces à dissection - pinces à dissection à griffes 160

D

DARBY-PERRY, instruments à détartrer 39

Daviers pour dents de sagesse 99

Daviers pour enfants, forme anglaise 102-105

Daviers pour fragments des racines 59-60

Daviers, forme américaine 106-115

Daviers, forme anglaise 85-101

DE BAKEY BAYONET, pinces atraumatiques 162

DE BAKEY, pinces atraumatiques 162

DE BAKEY, portes-aiguilles 188

DE BAKEY-GERALD, pinces atraumatiques 162

DEAN, ciseaux à chirurgie 154

DENHART, ouvre-bouches 168-169

DEPPELER, instruments à détartrer - détartrés faucilles 42

DERF, portes-aiguilles 181

DESMARRES, écarteurs 170

Détergent - spray huileux 250

E

Ecarteurs 170-174, 177

Ecarteurs des joues 178

Ecarteurs pour la chirurgie maxillo-faciale 175-176

Élévateurs à racines 66-82

EMOS, abaisse-langues 179

Excavateurs 118-119

F

FAHNENSTOCK, couteaux à cire 222

FARABEU, écarteur 177

FERGUSON-ACKLAND, ouvre-bouches 168

FLAGG, précelles (Brucelles) pour coton 19

FOSTER-GILLIES, portes-aiguilles 186

FRAHM, instruments pour plombages plastiques 131

FREER, ciseaux-burins, gouges 203

FREER, rugines-décolleurs pour la chirurgie maxillo-faciale 195

FRIEDMANN, élévateurs à racines 77

Inhaltsverzeichnis Index

Table des matières Indice Indice

FRIEDMANN, pinces gouges	205
FURRER, instruments pour couronnes	224

G

GÄRTNER, élévateurs à racines	68-69
GILLIES, portes-aiguilles	185-186
GLICKMANN, rugines - décolleurs pour la chirurgie maxillo-faciale..	195
GOLDMAN-FOX, ciseaux pour la chirurgie plastique	151
GOLDMAN-FOX, instruments à détartrer - détartréurs faucilles	43
GOLDMAN-FOX, instruments pour la parodontologie	34
GRACEY LARGE, instruments pour la parodontologie	27, 30, 31
GRACEY LARGE, instruments pour la parodontologie	27, 32, 33
GRACEY STANDARD, instruments pour la parodontologie	27, 28, 29
GRAEFE, pinces à dissection - pinces à dissection à griffes	159
GROSS-MAIER, pinces à champs	167

H

HALSEY, portes-aiguilles	183
HALSTED- MOSQUITO, pinces hémostatiques	163
HALSTED- MOSQUITO, pinces pour l'orthodontie	233
HARTMANN, pinces hémostatiques	163
HÉGAR-BAUMGÄRTNER, portes-aiguilles	182
HEIDBRINK, élévateurs à racines	81-82
HEIDEMANN, instruments pour plombages plastiques	124, 130
HEMINGWAY, curettes doubles	192
HENAHAN, daviers, forme américaine	106
HIRSCHFELD, limes pour la parodontologie	49
HIRSCHFELD, rugines-décolleurs pour la chirurgie maxillo-faciale ..	195
HOLLENBACK, instruments pour plombages plastiques	131
HOLLENBACK, instruments pour amalgame, guttapercha et ciment	121
HÖSEL, portes-aiguilles	185
HOW, pinces pour l'orthodontie	232
HYGIENIST, instruments à détartrer - détartréurs faucilles	40
HYGIENIST-TOWNER, instruments à détartrer - détartréurs faucilles..	40
HYLIN, élévateurs à racines	78

I

INDIA, pierres d'affûtage	44
INDIANA UNIVERSITY, instruments pour la parodontologie	35
Instrument pour ciment	237
Instruments à détartrer	38-39
Instruments à détartrer - détartréurs faucilles	40-43
Instruments pour amalgame, guttapercha et ciment	121
Instruments pour couronnes	224-227
Instruments pour la parodontologie	26-37
Instruments pour ligatures	237
Instruments pour l'orthodontie	229-238
Instruments pour mesurer	136, 222
Instruments pour plombages plastiques	123-132
Instruments Rubber Dam	133-134
Instruments Sinus-lift	209-210
IVORY, instruments Rubber Dam	133

J

JAQUETTE, instruments à détartrer - détartréurs faucilles	41
JAVANOVIC, prélèvement et application de matériel d'os	213

K

KELLY, ciseaux à chirurgie	146
KELLY, pinces hémostatiques	164

KELLY-RANKIN, pinces hémostatiques	164
KHOURY, rugines - décolleurs pour la chirurgie maxillo-faciale	196
KILNER, écarteurs	172
KILNER, portes-aiguilles	187
KIRKLAND, bistouris pour la gingivectomie	46
KIRKLAND, ciseaux parodontaux	52
KLEIN, daviers pour enfants, forme anglaise	104
KOCHER, pinces hémostatiques	165
KOCHER-LANGENBECK (OBWEGESER), écarteurs	174
KOPP, élévateurs à racines	67
KRAMER-NEVINS, ciseaux-burins, gouge	203
KROENIG, abaisse-langues	179

L

Lames de bistouris	142
LANGENBECK, écarteurs	174
LANGER, instruments pour la parodontologie	37
LECLUSE, élévateurs à racines	78
LICHTENBERG, portes-aiguilles	185
Limes à os	199
Limes pour la parodontologie	48-49
LINDO-LEVIN, élévateurs à racines	70
LISTER, ciseaux pour pansement	155
LISTON, pinces gouges / pinces coupantes à os	207
LOCKLIN, ciseaux fins	150
LONDON COLLEGE, pinces pour l'endodontie	58
LONDON COLLEGE, précelles (Brucelles) pour coton	20
LUCAS, curettes à os	197
LUER, pinces gouges	206
LUNIATSCHEK, portes coton	223

M

MAC FARLANE, instruments à détartrer - détartréurs faucilles	43
Maillets	200-201
Manches à miroirs	56
Manches de bistouri	141
MANNERFELT, ciseaux-burins, gouges	203
MARTINI, curettes doubles	191
MATHIEU, pinces pour l'orthodontie	232
MATHIEU, portes-aiguilles	184
MATHIEU-OLSEN, portes-aiguilles	182-183
MAYO-HEGAR, portes-aiguilles	184
MAZOUCH, instruments pour couronnes	225
MC CALL, instruments à détartrer	38
MC CALL, instruments pour la parodontologie	36
MC KELLOPS, pinces pour l'orthodontie	235
MEAD, daviers pour enfants, forme anglaise	105
MEAD, maillets	201
MEAD, pinces gouges	206
MERIAM, précelles (Brucelles) pour coton	18
MERSHON, instruments pour l'orthodontie	238
METZENBAUM, ciseaux à chirurgie	146-147
Micro ciseaux	153
Micro ciseaux avec manche ronde	152
Micro miroirs à résection	56
Micro pinces	161
Micro portes-aiguilles avec manche ronde	190
MICRO-ADSON, pinces à dissection / à griffes	157-158
Micro-lames	140
MICRO-MOSQUITO, pinces hémostatiques	163

Inhaltsverzeichnis
Index

Table des matières
Indice
Indice

MIDDELDORPF, écarteurs 171
 MILLER, élévateurs à racines77
 MILLER, limes à os 199
 MILLER, pinces pour papier à articuler..... 136
 MILLER-COLBURN, curettes à os 197-198
 MILLER-COLBURN, limes à os..... 199
 MINI- FRIEDMANN, pinces gouges205
 MINI-LAMBOTTE, ciseaux-burins, gouges204
 MINI-LANGENBECK, écarteurs 171
 Mirrors à bouche et manches 16-17
 MOD. «PLASTIC», instruments pour plombages plastiques 123
 MOLT MOD., ouvre-bouches.....169
 MOLT, curettes à os 198
 MOLT, ouvre-bouches.....168
 MOLT, rugines-décolleurs pour la chirurgie maxillo-faciale 195-196
 MORRISON, syndesmotomes83

N
 NEIVERT, portes-aiguilles 187
 NEUMANN, ciseaux fins 150
 NEVIUS, daviers, forme américaine.....111
 NOYES, ciseaux pour la gencive 153

O
 O'BRIAN, pinces pour l'orthodontie.....235
 OBWEGESER, écarteurs pour la chirurgie maxillo-faciale 175-176
 OBWEGESER, rugines-décolleurs pour la chirurgie maxillo-faciale ... 194
 OBWEGESER-FREER, rugines-décolleurs pour la chirurgie maxillo-faciale 194
 OCHSENBEIN, ciseaux parodontaux 51-53
 OLSEN-HEGAR, portes-aiguilles 183
 ORBAN, bistouris pour la gingivectomie46
 Osteotome 211
 Ouvre-bouches.....168-169

P
 Paradontomètres24-25
 PARMLY, daviers, forme américaine 109
 PÉAN, pinces hémostatiques 165
 PECK-JOSEF, ciseaux à chirurgie 148
 PEET, daviers pour fragments des racines.....59
 Périotomes, doubles65
 Périotomes, simples.....64
 PERRY, precelles (Brucelles) pour coton..... 19
 PHYSIK, daviers, forme américaine 106
 Pierres d'affûtage.....44
 Pinces à champs 167
 Pinces à dissection 156
 Pinces à dissection à griffes 157-160
 Pinces à marquer les poches périodontales47
 Pinces à saisir Brackets230
 Pinces atraumatiques 162
 Pinces coupantes.....239
 Pinces coupantes à os207
 Pinces de tissu.....166
 Pinces emporte-pièces à gencives208
 Pinces gouges..... 205-207
 Pinces hémostatiques..... 163-165
 Pinces pour aiguilles de nerfs 61
 Pinces pour endodontie58
 Pinces pour l'orthodontie231-236

Pinces pour papier à articuler 136
 Pinces tire-langue 178
 Porte lames et brise lames de rasoir.....143
 Portes coton223
 Portes-empreinte 218-221
 Porte-aiguilles 181-189
 Portes-amalgame 120
 Portes-matrices 134
 Précelles (Brucelles) pour coton..... 18-20
 PRICHARD, curettes chirurgicales.....50
 PRICHARD, rugines-décolleurs pour la chirurgie maxillo-faciale 195

Q
 QUINBY, ciseaux fins..... 150

R
 RAGNELL- DAVIS, écarteurs 173
 RALK, daviers pour fragments des racines59
 RHODES, ciseaux parodontaux52
 ROSER-KÖNIG, ouvre-bouches 168
 Rugines- élévateurs.....193
 Rugines-décolleurs pour la chirurgie maxillo-faciale..... 194-196

S
 SCHEUFLE, portes empreintes..... 221
 SCHLUGER, limes pour la parodontologie48
 SEBILEAU, rugines-décolleurs pour la chirurgie maxillo-faciale 194
 SELDIN, élévateurs à racines76
 SEMKEN, pinces à dissection.....156
 SEMKEN, pinces à dissection - pinces à dissection à griffes 160
 SENN-GREEN, écarteurs 173
 SENN-MILLER, écarteurs 172
 Séringues..... 138-139
 SHEEHAN, ciseaux-burins, gouges204
 Sondes et explorateurs21-22
 Sondes et explorateurs, simples57
 Spatules à ciment122
 SPECIAL, instruments pour la parodontologie36
 SPENCER, ciseaux pour la chirurgie plastique..... 151
 SPRENGEL, instruments pour plombages plastiques..... 131
 STANDARD, ciseaux à chirurgie..... 147
 STANDARD, daviers, forme américaine 106
 STANDARD, manches de bistouris 141
 STEIGMANN, prélèvement et application de matériel d'os 213
 STERNBERG, écarteurs de joues 178
 STIEGLITZ, daviers pour fragments des racines.....59
 STILLE, pinces à dissection..... 156
 SUGERMAN, limes pour la parodontologie48
 Syndesmotomes83

T
 TOFFLEMIRE, portes-matrices..... 134
 TOMATI, pinces emporte-pièces à gencives208
 TOWNER-JAQUETTE, détartreurs faucilles40
 TROUTMAN- CHRIS, porte lames et brise lames de rasoir 143
 TWEED LOOP, pinces pour l'orthodontie235
 TWEED STANDARD, pinces pour l'orthodontie233

Inhaltsverzeichnis Index

Table des matières
Indice
Indice

U

ULTRA-MICRO-ADSON (BRAKA), pinces à dissection, pinces à dissection à griffes	158
UNIVERSAL, ciseaux à chirurgie.....	154
UNIVERSAL, pinces pour l'orthodontie.....	235
USA, instruments pour amalgame, guttapercha et ciment	121

V

VANNAS, ciseaux micro avec manche ronde.....	152
VASCULAR, portes-aiguilles	187
Vis à racines	83

W

WACHTEL, rugine - décolleurs pour la chirurgie maxillo-faciale	196
WARD, instruments pour amalgame, guttapercha et ciment	121
WEBSTER, portes-aiguilles	182
WEIL-BLAKESLEY, pinces emporte-pièces à gencives.....	208
WEINGART, pinces pour l'orthodontie	231
WESTCOTT, instruments pour plombages plastiques.....	132
WESTCOTT, micro-ciseaux.....	153
WHITE, instruments pour plombages plastiques	132
WHITE, daviers, forme anglaise.....	100
WHITE, excavateurs.....	118
WIEDER, abaisses-langues	178
WILLIAMS, pinces de tissu	166
WILLIGER, curettes doubles	191
WILLIGER, rugines - élévateurs.....	193
WINTER, élévateurs à racine	80
WITZEL, daviers pour fragments des racines.....	60
WYNNMANN, instruments pour couronne	225

Y

YOUNG, pinces pour l'orthodontie	233
YOUNG, pinces tire-langue.....	178
YOUNGER-GOOD, instruments pour la parodontologie.....	36

Inhaltsverzeichnis
Index

Table des matières
Indice
Indice

A

Abrebocas..... 168-169

ADSON BROWN, Pinzas de disección - Pinzas de disección con dientes 157

ADSON, Raspatorios - Elevadores 193

ADSON, Pinzas de disección - Pinzas de disección con dientes . 157-158

ADSON-GRAEFE, Pinzas de disección - Pinzas de disección con dientes 157

AINSWORTH, Rubber Dam instrumentos..... 133

Alicates para cortar alambre.....239

ALLIS, Pinzas para tejidos..... 166

ALLIS-ADAIR, Pinzas para tejidos..... 166

ALLIS-BABY, Pinzas para tejidos..... 166

ANGLE (TWEED), Pinzas para la ortodoncia.....231

APICAL, Elevadores para raíces..... 76

Aplicador para ligaduras237

ARKANSAS, Mollejonas.....44

ASH, instrumentos para obturaciones plásticas..... 125

Aspirador, quirúrgico..... 137

AUTOMATIC, Instrumentos para coronas 224

B

BABY-CRILE-WOOD, Porta-agujas 182

BACKHAUS, Pinzas de campo 167

Baja lenguas 178

BARNHART, instrumentos paradontología.....35

BARRAQUER, Micro porta-agujascon mango redondo..... 190

BARRY, Elevadores para raíces.....79

BEEBEE, Tijeras para coronas 155, 225

BEIN, Elevadores para raíces66

BERNARD, Elevadores para raíces 73-74

Bisturí para encías 144

Bisturís para la gingivectomia46

BLACK, instrumentos para obturaciones plásticas..... 129 / 132

BLUMENTHAL, Pinzas gubias205

BÖHLER, Pinzas gubias / Pinzas cortantes para huesos207

Bone Pusher..... 211

BREWER, Rubber Dam instrumentos..... 133

BROPHY (SULLIVAN), Tijeras para cirugía 148

BRUENINGS, Espátulas bucales 179

BUSER, Raspatorios para la cirugía maxilofacial 196

BUSER, Toma y aplicación de material de huesos212, 214

C

CAEWOOD-MINNESOTA, Separador de mejillas 178

Cánulas..... 138

CASTROVIEJO- JACOBSON, Porta-agujas..... 189

CASTROVIEJO, Instrumentos de medición..... 136

CASTROVIEJO, Micro tijeras con mango redondo..... 152

CASTROVIEJO, Pinzas para sujetar y romper hojas de afeitar..... 143

CATTONI, Limpiadores de sarro..... 39

CHOMPRET, Sindesmotomos83

CHOMPRET, Tornillos para raíces.....83

Cinceles, gubias..... 202-204

CLEOID-DISCOLD, instrumentos para obturaciones plásticas..... 131

CLEVELAND, Pinzas gubias.....206

COLLEGE MODIF., Pinzas para algodón y curaciones.....20

COLLIN, Martillos.....201

COLUMBIA, instrumentos paradontología.....26

Contenedores dentales y accesorios 242-249

COTTLE, Martillos.....200

COTTLE, Molino de huesos..... 215

COTTLE, Separadores 172

CRANE-KAPLAN, Limpiadores de sarro - Limpiadores forma de hoz ..42

CRANE-KAPLAN, Pinzas para marcar bolsas periodontales.....47

CRILE, Pinzas hemostáticas 164

CRILE-MURRAY, Porta-agujas..... 181

CRILE-RANKIN, Pinzas hemostáticas..... 164

CRILE-WOOD, Porta-agujas..... 181

CRUYER, Elevadores para raíces76

Cubetas para impresiones 218-221

Cucharillas de doble extremo, afiladas..... 191-192

Cuchillos para cera222

Curetas para huesos 197-198

Curetas quirúrgicas.....50

CUSHING, Pinzas de disección..... 156

CUSHING, Pinzas de disección con dientes 160

D

DARBY-PERRY, Limpiadores de sarro39

DE BAKEY Bajoneta Pinzas de disección atraumáticas..... 162

DE BAKEY, Pinzas de disección atraumáticas..... 162

DE BAKEY, Porta-agujas 188

DE BAKEY-GERALD, Pinzas de disección atraumáticas..... 162

DEAN, Tijeras, quirúrgica 154

DENHART, Abrebocas 168-169

DEPELER, Limpiadores de sarro - Limpiadores forma de hoz42

DERF, Porta-agujas 181

DESMARRES, Separadores 170

Detergente - spray de aceite250

E

Elevadores para raíces 66-82

EMOS, Espátulas bucales..... 179

Espátulas bucales 179

Espátulas para cemento..... 122

Espejos de boca y mangos..... 16-17

Excavadores..... 118-119

F

FAHNENSTOCK, Cuchillos para cera222

FARABEUF, Separadores 177

FERGUSON-ACKLAND, Abrebocas.....168

FLAGG, Pinzas para algodón y curaciones 19

Forceps de extracción para cordales99

Forceps de extracción, forma americana 106-115

Forceps de extracción, forma inglesa..... 85-101

Forceps para fragmentos de raíces..... 59-60

Forceps para niños de extracción, forma inglesa 102-105

FOSTER-GILLIES, Porta-agujas 186

FRAHM, instrumentos para obturaciones plásticas..... 131

FREER, Cinceles, gubias.....203

FREER, Raspatorios para la cirugía maxilofacial 195

FRIEDMANN, Elevadores para raíces77

FRIEDMANN, Pinzas gubias.....205

FURRER, Instrumentos para coronas 224

G

Ganchos para la cirugía maxilofacial 175-176

GÄRTNER, Elevadores para raíces..... 68-69

GILLIES, Porta-agujas..... 185-186

GLICKMANN, Raspatorios para la cirugía maxilofacial 195

Inhaltsverzeichnis Index

Table des matières Indice Indice

GOLDMAN-FOX, instrumentos paradontología	34
GOLDMAN-FOX, Limpiadores de sarro - Limpiadores forma de hoz ...	43
GOLDMAN-FOX, Tijeras Tijeras para cirugía plástica	151
GRACEY LARGE, Instrumentos para paradontología	27, 30, 31
GRACEY SMALL, Instrumentos para paradontología	27, 32, 33
GRACEY STANDARD, Instrumentos para paradontología	27, 28, 29
GRAEFE, Pinzas de disección con dientes	159
GROSS-MAIER, Pinzas de campo	167

H

HALSEY, Porta-agujas	183
HALSTED- MOSQUITO, Pinzas hemostáticas	163
HALSTED- MOSQUITO, Pinzas para la ortodoncia	233
HARTMANN, Pinzas hemostáticas	163
HEGAR-BAUMGARTNER, Porta-agujas	182
HEIDBRINK, Elevadores para raíces	81-82
HEIDEMANN, instrumentos para obturaciones plásticas	124, 130
HEMINGWAY, Cucharillas de doble extremo, afiladas	192
HENAHAN, Forceps de extracción, forma americana	106
HIRSCHFELD, Limas para paradontología	49
HIRSCHFELD, Raspatorios para la cirugía maxilofacial	195
Hojas de bisturí	142
HOLLENBACK, instrumentos para amalgama, gutapercha y cemento	121
HOLLENBECK, instrumentos para obturaciones plásticas	131
HÖSEL, Porta-agujas	185
HOW, Pinzas para la ortodoncia	232
HYGIENIST, Limpiadores de sarro - Limpiadores forma de hoz	40
HYGIENIST-TOWNER, Limpiadores de sarro - Limpiadores forma de hoz ..	40
HYLIN, Elevadores para raíces	78

I

INDIA, Mollejes	44
INDIANA UNIVERSITY, instrumentos paradontología	35
Instrumento Sinus-lift	209
Instrumentos de medición	136, 222
Instrumentos para coronas	224-227
Instrumentos para la ortodoncia	229-238
Instrumentos para obturaciones plásticas	123-132
Instrumentos para paradontología	26-37
instrumentos para amalgama, gutapercha y cemento	121
IVORY, Rubber Dam instrumentos	133

J

JAQUETTE, Limpiadores de sarro - Limpiadores forma de hoz	41
JAVANOVIC, Toma y aplicación de material de huesos	213
Jeringas	138-139

K

KELLY, Pinzas hemostáticas	164
KELLY, Tijeras, quirúrgica	146
KELLY-RANKIN, Pinzas hemostáticas	164
KHOURY, Raspatorios para la cirugía maxilofacial	196
KILNER, Porta-agujas	187
KILNER, Separadores	172
KIRKLAND, Bisturís para la gingivectomía	46
KIRKLAND, Lima periodontal	52
KLEIN, Forceps para niños de extracción, forma inglesa	104
KOCHER, Pinzas hemostáticas	165
KOCHER-LANGENBECK (OBWEGESER), Separadores	174
KOPP, Elevadores para raíces	67

KRAMER-NEVINS, Cinceles, gubias	203
KROENIG, Espatulas bucales	179

L

LANGENBECK, Separadores	174
LANGER, instrumentos paradontología	37
LECLUSE, Elevadores para raíces	78
LICHTENBERG, Porta-agujas	185
Lima de hueso	199
Lima periodontal	51-53
Limas para paradontología	48-49
Limpiadores de sarro	38-39
Limpiadores de sarro - Limpiadores forma de hoz	40-43
LINDO-LEVIN, Elevadores para raíces	70
LISTER, Tijeras para cirugía	155
LISTON, Pinzas gubias / Pinzas cortantes para huesos	207
LOCKLIN, Tijeras, finas	150
LONDON COLLEGE, Pinzas para algodón y curaciones	20
LONDON COLLEGE, Pinzas para endodoncia	58
LUCAS, Curetas para huesos	197
LUER, Pinzas gubias	206
LUNIATSCHEK, Porta algodón	223

M

MAC FARLANE, Limpiadores de sarro - Limpiadores forma de hoz	43
Mangos de bisturí	141
Mangos para espejos	56
MANNERFELT MODIF., Cinceles, gubias	203
Martillos	200-201
MARTINI, Cucharillas de doble extremo, afiladas	191
MATHIEU, Pinzas para la ortodoncia	232
MATHIEU, Porta-agujas	184
MATHIEU-OLSEN, Porta-agujas	182-183
MAYO-HEGAR, Porta-agujas	184
MAZOUCH, DR., Instrumentos para coronas	225
MC CALL, instrumentos paradontología	36
MC CALL, Limpiadores de sarro	38
MC KELLOPS, Pinzas para la ortodoncia	235
MEAD, Forceps para niños de extracción, forma inglesa	105
MEAD, Martillos	201
MEAD, Pinzas gubias	206
MERIAM, Pinzas para algodón y curaciones	18
MERSHON, Instrumentos para ortodoncia	238
METZENBAUM, Tijeras quirúrgicas	146-147
Micro pinzas	161
Micro porta-agujas con mango redondo	190
Micro tijeras	153
Micro tijeras con mango redondo	152
MICRO-ADSON, Pinzas de disección - Pinzas de disección con dientes	157-158
Micro-espejos de resección	56
Micro-hojas	140
MICRO-MOSQUITO, Pinzas hemostáticas	163
MIDDELDORPF, Separadores	171
MILLER, Elevadores para raíces	77
MILLER, Lima de hueso	199
MILLER, Pinza para papel de articular	136
MILLER-COLBURN, Curetas para huesos	197-198
MILLER-COLBURN, Lima de hueso	199
MINI-FRIEDMANN, Pinzas gubias	205
MINI-LAMBOTTE, Cinceles, gubias	204

Inhaltsverzeichnis
Index

Table des matières
Indice
Indice

MINI-LANGENBECK, Separadores 171
 MOD. «PLASTIC», instrumentos para obturaciones plásticas 123
 Molino de huesos 215
 Mollejones 44
 MOLT, Raspatorios para la cirugía maxilofacial 195-196
 MOLT MOD., Abrebocas 169
 MOLT, Abrebocas 168
 MOLT, Curetas para huesos 198
 MORRISON, Sindesmotomos 83

N

NEIVERT, Porta-agujas 187
 NEUMANN, Tijeras finas 150
 NEVIUS, Forceps de extracción, forma americana 111
 NOYES, Tijeras para encías 153

O

O'BRIAN, Pinzas para la ortodoncia 235
 OBWEGESER, Ganchos para la cirugía maxilofacial 175-176
 OBWEGESER, Raspatorios para la cirugía maxilofacial 194
 OBWEGESER-FREER, Raspatorios para la cirugía maxilofacial 194
 OCHSENBEIN, Lima periodontal 51-53
 OLSEN-HEGAR, Porta-agujas 183
 ORBAN, Bisturís para la gingivectomia 46
 Osteotomo 211

P

PARMLY, Forceps de extracción, forma americana 109
 PÉAN, Pinzas hemostáticas 165
 PECK-JOSEF, Tijeras para cirugía 148
 PEET, Forceps para fragmentos de raíces 59
 Peridontómetros 24-25
 Periótomos, dobles 65
 Periótomos, simples 64
 PERRY, Pinzas para algodón y curaciones 19
 PHYSIK, Forceps de extracción, forma americana 106
 Pinza para papel de articular 136
 Pinzas cortantes para huesos 207
 Pinzas de campo 167
 Pinzas de disección 160
 Pinzas de disección con dientes 157-160
 Pinzas de disección atraumáticas 162
 Pinzas gubias 205-207
 Pinzas hemostáticas 163-165
 Pinzas para agujas de nervios 61
 Pinzas para algodón y curaciones 18-20
 Pinzas para coger Brackets 230
 Pinzas para endodoncia 58
 Pinzas para la ortodoncia 231-236
 Pinzas para marcar bolsas periodontales 47
 Pinzas para sujetar y romper hojas de afeitar 143
 Pinzas para tejidos 166
 Pinzas tiralengua 178
 Porta algodón 223
 Porta para micro-hojas 140
 Porta-agujas 181-189
 Porta-amalgama 120
 Portamatrices 134
 PRICHARD, Curetas quirúrgicas 50

PRICHARD, Raspatorios para la cirugía maxilofacial 195
 Punzones para encía 208

Q

QUINBY, Tijeras finas 150

R

RAGNELL-DAVIS, Separadores 173
 RALK, Forceps para fragmentos de raíces 59
 Rascador para cemento 237
 Raspatorios - Elevadores 193
 Raspatorios para la cirugía maxilofacial 194-196
 RHODES, Lima periodontal 52
 ROSER-KÖNIG, Abrebocas 168
 Rubber Dam instrumentos 133-134

S

SCHEUFLE, Cubetas para impresiones 221
 SCHLUGER, Limas para paradontología 48
 SEBILÉAU, Raspatorios para la cirugía maxilofacial 194
 SELDIN, Elevadores para raíces 76
 SEMKEN, Pinzas de disección & Pinzas de disección con dientes 160
 SEMKEN, Pinzas de disección 156
 SENN-GREEN, Separadores 173
 SENN-MILLER, Separadores 172
 Separador de mejillas 178
 Separadores 170-174, 177
 SHEEHAN, Cinceles, gubias 204
 Sindesmotomos 83
 Sinus-lift-instrumentos 209-210
 Sondas y exploradores 21-22
 Sondas y exploradores, simples 57
 SPECIAL, instrumentos paradontología 36
 SPENCER, Tijeras para cirugía plástica 151
 SPRENGEL, instrumentos para obturaciones plásticas 131
 STANDARD, Forceps de extracción, forma americana 106
 STANDARD, Mangos de bisturí 141
 STANDARD, Tijeras para cirugía 147
 STEIGMANN, Toma y aplicación de material de huesos 213
 STERNBERG, Separador de mejillas 178
 STIEGLITZ, Forceps para fragmentos de raíces 59
 STILLE, Pinzas de disección 156
 SUGERMAN, Limas para paradontología 48

T

Tijeras para cirugía plástica 151
 Tijeras para coronas 154-155
 Tijeras para coronas 154
 Tijeras para encías 149
 Tijeras quirúrgicas 146-148, 154-155
 Tijeras, finas 150
 TOFFLEMIRE, Portamatrices 134
 Toma y aplicación de material de huesos 212-214
 TOMATI, Punzones para encía 208
 Tornillos para raíces 83
 TOWNER-JAQUETTE, Limpiadores forma de hoz 40
 TROUTMAN-CHRIS, Pinzas para sujetar y romper hojas de afeitar 143
 TWEED LOOP, Pinzas para la ortodoncia 235
 TWEED STANDARD, Pinzas para la ortodoncia 233

Inhaltsverzeichnis
Index

Table des matières
Indice
Indice

U

ULTRA-MICRO-ADSON (BRAKA), Pinzas de disección con dientes ...	158
UNIVERSAL, Pinzas para la ortodoncia.....	235
UNIVERSAL, Tijera quirúrgica.....	154
USA, instrumentos para amalgama, gutapercha y cemento	121

V

VANNAS, Micro tijeras con mango redondo.....	152
VASCULAR, Porta-agujas	187

W

WACHTEL, Raspatorios para la cirugía maxilofacial.....	196
WARD, instrumentos para amalgama, gutapercha y cemento	121
WEBSTER, Porta-agujas.....	182
WEIL-BLAKESLEY, Punzones para encía	208
WEINGART, Pinzas para la ortodoncia	231
WESTCOTT, instrumentos para obturaciones plásticas.....	132
WESTCOTT, micro-tijeras.....	153
WHITE, Excavadores.....	118
WHITE, Forceps de extracción, forma inglesa	100
WHITE, instrumentos para obturaciones plásticas	132
WIEDER, Baja lenguas	178
WILLIAMS, Pinzas para tejidos.....	166
WILLIGER, Cucharillas de doble extremo, afiladas.....	191
WILLIGER, Raspatorios - Elevadores.....	193
WINTER, Elevadores para raíces.....	80
WITZEL, Forceps para fragmentos de raíces	60
WYNNMANN, Instrumentos para coronas	225

Y

YOUNG, Pinzas para la ortodoncia	233
YOUNG, Pinzas tiralengua	178
YOUNGER-GOOD, instrumentos paradontología.....	36

Inhaltsverzeichnis
Index

Table des matières
Indice
Indice

A

Abbassalingua..... 178, 179

ADSON BROWN, pinze per dissezione - pinze dissezione con denti . 157

ADSON, periostotomi - elevatori 193

ADSON, pinze per dissezione - pinze dissezione con denti..... 157-158

ADSON-GRAEFE, pinze per dissezione - pinze dissezione con denti . 157

AINSWORTH, strumenti Rubber Dam 133

ALLIS, pinze per tessuti..... 166

ALLIS-ADAIR, pinze per tessuti 166

ALLIS-BABY, pinze per tessuti 166

ANGLE (TWEED), pinze ortodontiche..... 231

APICAL, leve..... 76

Apribocca..... 168-169

ARKANSAS, mole 44

ASH, strumenti per otturazione..... 125

AUTOMATIC, strumenti per corone 224

B

BABY-CRILE-WOOD, porta aghi 182

BACKHAUS, pinze fissateli 167

BARNHART, strumenti per paradontologia 35

BARRAQUER, micro porta aghi con manico rotondo 190

BARRY, leve..... 79

BEEBEE, forbici per corone..... 155, 225

BEIN, leve..... 66

BERNARD, leve..... 73-74

Bisturi per gingivectomia..... 46

BLACK, strumenti per otturazione..... 129 / 132

BLUMENTHAL, pinze sgorbie..... 205

BÖHLER, pinze sgorbie / cesoie per ossa 207

BREWER, strumenti Rubber Dam..... 133

BROPHY (SULLIVAN), forbici per chirurgia 148

BRUENINGS, abbassalingua 179

BUSER, raspari per chirurgia massilofaciale..... 196

BUSER, strumenti per prelievo ed applicazione ossa..... 212, 214

C

CAEWOOD-MINNESOTA, divaricatori per guancia 178

Cannule d'aspirazione 137

Canule 138

CASTROVIEJO- JACOBSON, porta aghi 189

CASTROVIEJO, forbici per micro chirurgia con manico rotondo 152

CASTROVIEJO, rompi-lame di rasoio 143

CASTROVIEJO, strumenti di misura 136

CATTONI, levatartaro 39

Cesoie per ossa 207

CHOMPRET, syndesmotomi 83

CHOMPRET, viti per radici..... 83

CLEOID-DISCOLD, strumenti per otturazione..... 131

CLEVELAND, pinze sgorbie 206

COLLEGE MODIF., pinzette da medicazione 20

COLLIN, martelli 201

Coltelli per cera 222

Coltelli per gengive 144

COLUMBIA, strumenti per paradontologia 26

Container ed accessori dentali..... 242-249

COTTLE, divaricatori..... 172

COTTLE, martelli 200

COTTLE, mulino per ossa 215

CRANE-KAPLAN, pinzette per marcare le tasche 47

CRANE-KAPLAN, porta aghi 181

CRANE-KAPLAN, strumenti levatartaro 42

CRILE, pinze emostatiche..... 164

CRILE-RANKIN, pinze emostatiche 164

CRILE-WOOD, porta aghi..... 181

CROWN SCISSORS, forbici per corone 154

CRYER, leve..... 76

Curette doppie..... 191-192

Curette per ossa 197-198

Curette sinus-lift 209

Curette, chirurgiche 50

CUSHING, pinze per dissezione - pinze per dissezione con denti 160

CUSHING, pinzette anatomiche 156

D

DARBY-PERRY, strumenti levatartaro 39

DE BAKEY BAYONET, pinze per dissezione atraumatiche 162

DE BAKEY, pinze per dissezione, atraumatiche 162

DE BAKEY, porta aghi..... 188

DE BAKEY-GERALD, pinze per dissezione, atraumatiche 162

DEAN, forbici per chirurgia..... 154

DENHART, apribocca 168-169

DEPELER, strumenti levatartaro 42

DERF, porta aghi 181

DESMARRES, divaricatori 170

Detergente - olio speciale spray 250

Divaricatori 170-174, 177

Divaricatori per guancia 178

E

EMOS, abbassalingua 179

Escavatori 118-119

F

FAHNENSTOCK, coltelli per cera 222

FARABEUF, divaricatori 177

FERGUSON-ACKLAND, apribocca 168

FLAGG, pinzette da medicazione..... 19

Forbici fini..... 150

Forbici per chirurgia..... 146-148, 154-155

Forbici per chirurgia plastica..... 151

Forbici per corone..... 154-155

Forbici per gengive..... 149

Forbici per microchirurgia con manico rotondo..... 152

FOSTER-GILLIES, porta aghi 186

FRAHM, strumenti per otturazione..... 131

FREER, raspari per chirurgia massilofaciale 195

FREER, sgorbi 203

FRIEDMANN, leve 77

FRIEDMANN, pinze sgorbie 205

FURRER, strumenti per corone..... 224

G

GÄRTNER, leve 68-69

GILLIES, porta aghi 185-186

GLICKMANN, raspari per chirurgia massilofaciale..... 195

GOLDMAN-FOX, forbici per chirurgia plastica 151

GOLDMAN-FOX, strumenti levatartaro 43

GOLDMAN-FOX, strumenti per paradontologia 34

GRACEY LARGE, strumenti per paradontologia 27, 30, 31

Inhaltsverzeichnis Index

Table des matières Indice Indice

GRACEY SMALL, strumenti per paradontologia	27, 32, 33
GRACEY STANDARD, strumenti per paradontologia	27, 28, 29
GRAEFE, pinze per dissezione - pinze per dissezione con denti	159
GROSS-MAIER, pinze fissateli	167

H

HALSEY, porta aghi	183
HALSTED- MOSQUITO, pinze emostatiche	163
HALSTED- MOSQUITO, pinze ortodontiche	233
HARTMANN, pinze emostatiche	163
HEGAR-BAUMGARTNER, porta aghi	182
HEIDBRINK, leve	81-82
HEIDEMANN, strumenti per otturazione	124, 130
HEMINGWAY, curette doppie	192
HENAHAN, pinze da estrazione, forma americana	106
HIRSCHFELD, lime per paradontologia	49
HIRSCHFELD, raspari per chirurgia massilofaciale	195
HOLLENBACK, strumenti per amalgama, guttapercha e cemento ...	121
HOLLENBECK, strumenti per otturazione	131
HÖSEL, porta aghi	185
HOW, pinze ortodontiche	232
HYGIENIST, levartartaro.....	40
HYGIENIST-TOWNER, levartartaro.....	40
HYLIN, leve	78

I

INDIA, mole.....	44
INDIANA UNIVERSITY, strumenti per parodontologia	35
IVORY, strumenti Rubber Dam	133

J

JAQUETTE, strumenti levartartaro	41
JAVANOVIC, strumenti per prelievo ed applicazione ossa.....	213

K

KELLY, forbici per chirurgia	146
KELLY, pinze emostatiche.....	164
KELLY-RANKIN, pinze emostatiche.....	164
KHOURY, raspari per chirurgia massilofaciale	196
KILNER, divaricatori	172
KILNER, porta aghi.....	187
KIRKLAND, bisturi per gingivectomia	46
KIRKLAND, scalpelli paradontali	52
KLEIN, pinze da estrazione per bambini, forma inglese	104
KOCHER, pinze emostatiche	165
KOCHER-LANGENBECK (OBWEGESER), divaricatori	174
KOPP, leve.....	67
KRAMER-NEVINS, scalpelli.....	203
KROENIG, abbassalingua	179

L

Lame per bisturi.....	142
LANGENBECK, divaricatori.....	174
LANGER, strumenti per parodontologia	37
LECLUSE, leve.....	78
Leve	66-82
LICHTENBERG, porta aghi	185
Lime di ossa.....	199
Lime per parodontologia	48-49
LINDO-LEVIN, leve	70

LISTER, forbici per bendaggi	155
LISTON, pinze sgorbie / cesoie per ossa	207
LOCKLIN, forbici fini.....	150
LONDON COLLEGE, pinzette per endonzia.....	58
LONDON COLLEGE, pinzette per medicazione	20
LUCAS, curette per osse	197
LUER, pinze sgorbie	206
LUNIATSCHEK, porta tamponi	223

M

MAC FARLANE, strumenti levartartaro	43
Manici per bisturi.....	141
Manici per specchietti	56
MANNERFELT MODIF., scalpelli, sgorbi	203
Martelli	200-201
MARTINI, curette doppie	191
MATHIEU, pinze ortodontiche	232
MATHIEU, porta aghi	184
MATHIEU-OLSEN, porta aghi.....	182-183
MAYO-HEGAR, porta aghi	184
MAZOUCH, DR., strumenti per corone	225
MC CALL, strumenti levartartaro	38
MC CALL, strumenti per parodontologia	36
MC KELLOPS, martelli	201
MC KELLOPS, pinze ortodontiche	235
MEAD, pinze da estrazione per bambini, forma inglese	105
MEAD, pinze sgorbie	206
MERIAM, pinzette da medicazione	18
MERSHON, strumenti per ortodonzia.....	238
METZENBAUM, forbici per chirurgia.....	146-147
Micro forbici.....	153
Micro pinze	161
Micro porta aghi con manico rotondo	190
Micro specchietti e manici	56
MICRO-ADSON, pinze per dissezione - dissezione con denti	157-158
Micro-lame.....	140
MICRO-MOSQUITO, pinze emostatiche	163
MIDDELDORPF, divaricatori	171
MILLER, leve	77
MILLER, lime di ossa	199
MILLER, pinzette per articolazione.....	136
MILLER-COLBURN, curette per osso	197-198
MILLER-COLBURN, lime di ossa	199
MINI- FRIEDMANN, pinze sgorbie	205
MINI-LAMBOTTE, scalpelli	204
MINI-LANGENBECK, divaricatori	171
MOD. «PLASTIC», strumenti per otturazione	123
Mole.....	44
MOLT MOD., apribocca	169
MOLT, apribocca	168
MOLT, curette per osso	198
MOLT, raspari per chirurgia massilofaciale	195-196
MORRISON, syndesmotomi.....	83
Molino per ossa	215

N

NEIVERT, porta aghi	187
NEUMANN, forbici fini	150
NEVIUS, pinze da estrazione, forma americana	111
NOYES, forbici per gengive.....	153

**Inhaltsverzeichnis
Index**
**Table des matières
Indice
Indice**

O	
O'BRIAN, pinze ortodontiche	235
OBWEGESER, raspari per chirurgia massilofaciale	194
OBWEGESER, uncini per chirurgia massilofaciale	175-176
OBWEGESER-FREER, raspari per chirurgia massilofaciale	194
OCHSENBEIN, scalpelli paradontali	51-53
OLSEN-HEGAR, porta aghi	183
ORBAN, bisturi per gingivectomia	46
Osteotomi	211

P	
PARMLY, pinze da estrazione, forma americana	109
PÉAN, pinze emostatiche	165
PECK-JOSEF, forbici per chirurgia	148
PEET, pinze per frammenti	59
Peridotometri	24-25
Periostotomi - elevatori	193
Periotomi, doppi	65
Periotomi, singoli	64
PERRY, pinzette da medicazione	19
PHYSIK, pinze da estrazione, forma americana	106
Pinze da estrazione denti del giudizio	99
Pinze da estrazione per bambini, forma inglese	102-105
Pinze da estrazione, forma inglese	85-101
Pinze da estrazione, forma americana	106-115
Pinze emostatiche	163-165
Pinze fissateli	167
Pinze per aghi di nervi	61
Pinze per dissezione	156
Pinze per dissezione atraumatiche	162
Pinze per dissezione con denti	157-160
Pinze per frammenti	59-60
Pinze per ortodonzia	231-236
Pinze per tessuti	166
Pinze sgorbie	205-207
Pinze taglia filo	239
Pinze taglienti per gengive	208
Pinze tiralingua	178
Pinzette per articolazione	136
Pinzette per endodonzia	58
Pinzette per marcare le tasche	47
Pinzette per medicazione	18-20
Pinzette porta bracket	230
Portaimpronte	218-221
Porta amalgama	120
Porta micro-lame	140
Porta tamponi	223
Portamatrici	134
PRICHARD, curette chirurgiche	50
PRICHARD, raspari per chirurgia massilofaciale	195

Q	
QUINBY, forbici fini	150

R	
RAGNELL- DAVIS, divaricatori	173
RALK, pinze per frammenti	59
Raschiatori	237
Raspari per chirurgia massilofaciale	194-196
RHODES, scalpelli paradontali	52

Rompi-lame di rasoio	143
ROSER-KÖNIG, apribocca	168
Rubber Dam, strumenti	133-134

S	
Scalpelli paradontali	51-53
Scalpelli per ossa	202-204
SCHEUFLE, portaimpronte	221
SCHLUGER, lime per parodontologia	48
SEBILEAU, raspari per chirurgia massilofaciale	194
SELDIN, leve	76
SEMKEN, pinze per dissezione - pinze per dissezione con denti	160
SEMKEN, pinzette anatomiche	156
SENN-GREEN, divaricatori	173
SENN-MILLER, divaricatori	172
SHEEHAN, scalpelli, sgorbi	204
Siringhe	138-139
Sonde d'esplorazione	21-22
Sonde d'esplorazione, singole	57
Spatole per cemento	122
Specchietti per bocca e manici	16-17
SPECIAL, strumenti per parodontologia	36
SPENCER, forbici per chirurgia plastica	151
Spingi ossa	211
SPRENGEL, strumenti per otturazione	131
STANDARD, forbici per chirurgia	147
STANDARD, manici per bisturi	141
STANDARD, pinze da estrazione, forma americana	106
STEIGMANN, strumenti per prelievo ed applicazione ossa	213
STERNBERG, divaricatori per guancia	178
STIEGLITZ, pinze per frammenti	59
STILLE, pinzette anatomiche	156
Strumenti di misura	136, 222
Strumenti levatartaro	38-43
Strumenti per amalgama, guttapercha e cemento	121
Strumenti per corone	224-227
Strumenti per ligatura	237
Strumenti per ortodonzia	229-238
Strumenti per otturazione	123-132
Strumenti per parodontologia	26-37
Strumenti per prelievo ed applicazione ossa	212-214
Strumenti sinus-lift	209-210
SUGERMAN, lime per parodontologia	48
Syndesmotomi	83

T	
TOFFLEMIRE, portamatrici	134
TOMATI, pinze taglienti per gengive	208
TOWNER-JAQUETTE, strumenti levatartaro	40
TROUTMAN- CHRIS, rompi-lame di rasoio	143
TWEED LOOP, pinze ortodontiche	235
TWEED STANDARD, pinze ortodontiche	233

U	
ULTRA-MICRO-ADSON (BRAKA), pinze per dissezione - pinze per dissezione con denti	158
Uncini per chirurgia massilofaciale	175-176
UNIVERSAL, forbici per chirurgia	154
UNIVERSAL, pinze ortodontiche	235
USA, strumenti per amalgama, guttapercha e cemento	121

Inhaltsverzeichnis
Index

Table des matières
Indice
Indice

V

VANNAS, forbici per micro chirurgia con manico rotondo	152
VASCULAR, porta aghi	187
Viti per radici	83

W

WACHTEL, raspari per chirurgia massilofaciale	196
WARD, strumenti per amalgama, guttapercha e cemento	121
WEBSTER, porta aghi	182
WEIL-BLAKESLEY, pinze taglienti per gengive	208
WEINGART, pinze ortodontiche	231
WESTCOTT, strumenti per otturazione	132
WESTCOTT, micro-forbici.....	153
WHITE, escavatori	118
WHITE, pinze da estrazione, forma inglese	100
WHITE, strumenti per otturazione	132
WIEDER, abbassalingua	178
WILLIAMS, pinze per tessuti	166
WILLIGER, curette doppie	191
WILLIGER, periostotomi - elevatori	193
WINTER, leve	80
WITZEL, pinze per frammenti	60
WYNNMANN, strumenti per corone.....	225

Y

YOUNG, pinze ortodontiche	233
YOUNG, pinze tiralingua.....	178
YOUNGER-GOOD, strumenti per parodontologia	36



*Solutions for surgery,
endoscopy and dental.*

*With over 10.000 products of highest
quality in our portfolio we are able to
fulfill even most extraordinary requests.*

*makes
the difference*

TEKNO-MEDICAL Optik-Chirurgie GmbH
Sattlerstrasse 11 · 78532 Tuttlingen, Germany
Telefon +49 (74 61) 17 01-0 · Fax +49 (74 61) 17 01-50
mail@tekno-medical.com · www.tekno-medical.com

Wichtige Hinweise

Dieser Katalog bleibt Eigentum der Firma TEKNO-MEDICAL Optik-Chirurgie GmbH, auch wenn dafür eine Schutzgebühr bezahlt wurde. Er kann von uns jederzeit zurückgefordert werden, wenn er gegen unsere Interessen und nicht zum Vertrieb und Einkauf von TEKNO Produkten verwendet wird. Auch behalten wir uns in solch einem Falle weitergehende Maßnahmen vor.

Der Nachdruck oder Kopieren dieses Kataloges – im Gesamten oder auch nur auszugsweise – ist ohne unsere schriftliche Genehmigung verboten. Modelländerungen vorbehalten. Gedruckt in der Bundesrepublik Deutschland

Important notice

This catalogue remains property of TEKNO-MEDICAL Optik-Chirurgie GmbH even if we have asked for a lending fee. We can at any time recall the catalogue, in case that it has been not used according to our interests, i.e. sale or purchase of TEKNO products. We preserve the right for further steps in that case.

Reproduction or copying of this catalogue in whole or in parts is forbidden without our written permission. Patterns are subject to change. Printed in Germany

Indications importantes

Ce catalogue reste la propriété de TEKNO-MEDICAL Optik-Chirurgie GmbH, même si nous avons demandé le paiement d'une taxe de protection. Nous pouvons demander le retour du catalogue dans le cas où celui-ci n'est pas utilisé conformément à nos intérêts, pour la vente ou l'achat de nos produits. Dans ce cas nous nous réservons le droits de mener des actions juridiques.

La reproduction ou la copie totale ou partielle de ce catalogue est interdite sans notre accord écrit. Sous réserve des modifications techniques. Imprimé en Allemagne

Avisos importantes

Este catálogo es propiedad de TEKNO-MEDICAL Optik-Chirurgie GmbH, aún en el caso de haber abonado por él una tasa de colaboración. Podemos solicitar la devolución del catálogo en caso de que no sea utilizado para la compra o venta de nuestros productos. En este caso nos reservamos el derecho de tomar medidas jurídicas.

La reproducción o copia total o parcial de este catálogo esta prohibido sin nuestro consentimiento escrito. Salvo modificaciones técnicas. Impreso en la República Federal de Alemania

Avvertenze importanti

Questo catalogo rimane proprietà della TEKNO-MEDICAL Optik-Chirurgie GmbH, anche se è stato rilasciato gratuitamente contro pagamento. Possiamo in ogni momento richiederlo indietro, in caso non stato usato in accordo con i nostri interessi (acquisto e vendita dei prodotti TEKNO-Medical). Ci riserviamo in questo caso il diritto di prendere ulteriori provvedimenti.

La copia o la riproduzione di questo catalogo in parte o nella sua totalità è vietata senza il nostro permesso scritto. Ci riserviamo la facoltà di cambiamenti nei modelli. Stampato in Germania



TEKNO-MEDICAL Optik-Chirurgie GmbH

Sattlerstrasse 11 · 78532 Tuttlingen, Germany
Telefon +49 (74 61) 1701-0 · Fax +49 (74 61) 1701-50
mail@tekno-medical.com · www.tekno-medical.com

© 08.2013 - TEKNO-MEDICAL Optik-Chirurgie GmbH
TEKNO is a registered trademark of TEKNO-MEDICAL Optik-Chirurgie GmbH