



Knochenchirurgie
Bone surgery

Chirurgie osseuse
Cirurgía ósea
Chirurgia ossea



Amputations- und Resektionssägen
Amputating and resection saws

Scies à amputation et résection
Sierra para amputación y resección
Seghe per amputazione



CHARRIÈRE

350 mm – 13³/₄"

tk 24001-35



12 mm

tk 24001-12

15 mm

tk 24001-15

Ersatzsägeblätter
Spare saw blades

Lames de rechange

Hojas de cambio

Lame di ricambio



**HELFERICH-
BIER**

390 mm – 15¹/₂"

tk 24002-39



3 mm

tk 24002-03

5 mm

tk 24002-05

7 mm

tk 24002-07

Ersatzsägeblätter

Spare saw blades

Lames de rechange

Hojas de cambio

Lame di ricambio

Amputations- und Resektionssägen
Amputating and resection saws

Scies à amputation et résection
Sierra para amputación y resección
Seghe per amputazione



SATTERLEE

310 mm – 12¼"

tk 24003-31



LANGENBECK

230 mm – 9"

tk 24004-23



CHARRIÈRE

270 mm – 10¾"

tk 24005-27

300 mm – 12"

tk 24005-30

340 mm – 13½"

tk 24005-34

Raspeln, Feilen
Rasps, files

Râpes, limes
Escofinas, limas
Raspe, lime

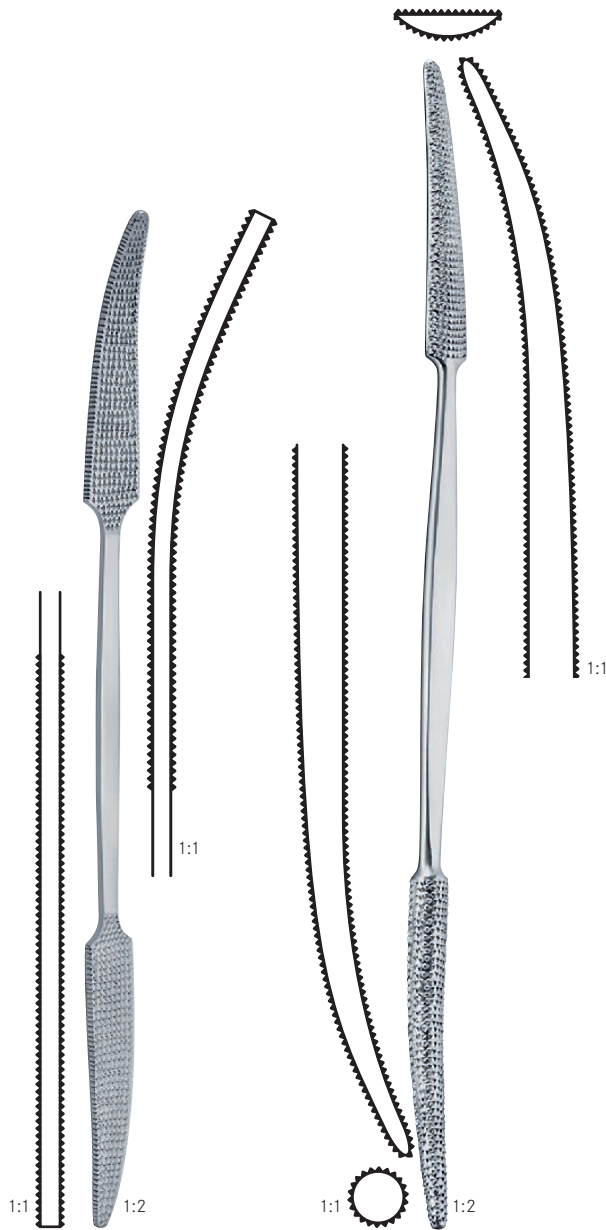

PUTTI

270 mm – 10¾"	tk 24011-27	
300 mm – 12"		tk 24010-30



280 mm – 11"	tk 24014-28
--------------	--------------------

245 mm – 9¾"	tk 24015-24
x = 13 mm	

220 mm – 8¾"	tk 24016-22
x = 20 mm	

halbrund
semicircular
semi-ronde
semi-redonda
semi-rotonda

halbrund
semicircular
semi-ronde
semi-redonda
semi-rotonda

flach
flat
plate
plana
piatta

Hämmer
Mallets

Maillets
Martillos
Martelli



DOYEN

	195 mm – 7¾"
25 mm Ø – 120 g	tk 24025-21
30 mm Ø – 180 g	tk 24030-21
35 mm Ø – 260 g	tk 24035-21

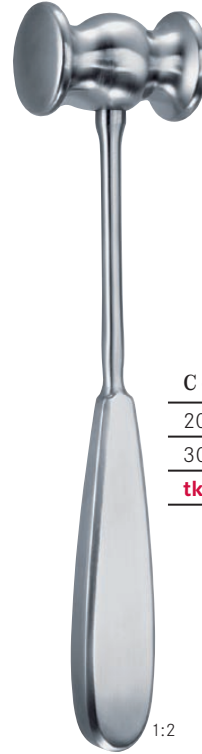

COLLIN

	200 mm – 8"
30 mm Ø – 220 g	tk 24051-20

1:2

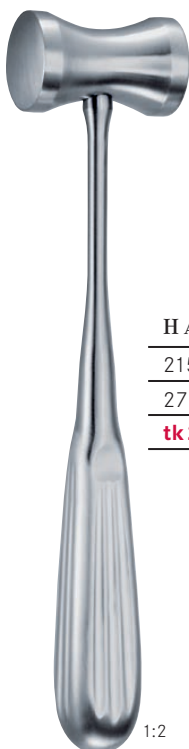

HAJEK

	215 mm – 8½"
27 mm Ø – 140 g	tk 24047-21

1:2



KIRK

	190 mm – 7½"
38 mm Ø – 750 g	tk 24040-19

1:2

Hämmer | Maillets
 Mallets | Martillos
 Martelli

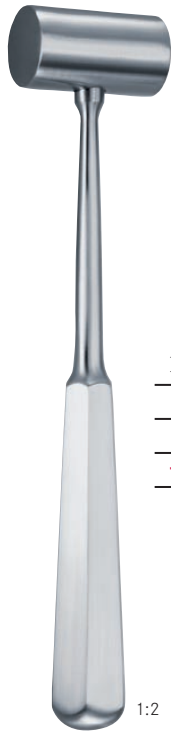

PARTSCH
 180 mm – 7"
 22 mm Ø – 200 g
tk 24053-18

1:2

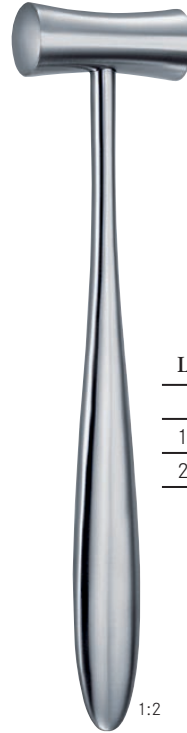

LUCAE
 190 mm – 7½"
 19 mm Ø – 230 g **tk 24057-01**
 25 mm Ø – 260 g **tk 24057-02**

1:2

Hämmer | Maillets
Mallets | Martillos
Martelli



1:2
BERGMANN
245 mm – 9¾"
45 mm Ø – 300 g
tk 24043-24



1:2
OMBREDANNE
240 cm – 9½"
40 mm Ø – 550 g
tk 24041-24



HEATH

40 mm Ø – 700 g	180 mm – 7"	tk 24044-18
45 mm Ø – 1000 g	200 mm – 8"	tk 24044-20

Kupferfüllung
Copper filled head
Rempli de cuivre
Llenado de cobre
Riempito di rame

Hämmer | Maillets
Mallets | Martillos
Martelli



1:2

190 mm – 7½"

250 mm Ø – 205 g

tk 24056-19

Massiver Stahl, mit Kunststoffbacken
Solid steel, with plastic faces

Acier solid, avec plaques en plastique
Acero solido, con placas en plastica
Acciaio massiccio, con punte di plastica

tk 24056-90

Ersatzbacken, 1 Paar
Spare faces, 1 pair

Plaques de rechange, 1 paire
Placas de cambio, 1 par
Punte di ricambio, 1 paio



1:2

COTTLE

185 mm – 7¼"

30 mm Ø – 240 g

tk 50581-19

1 Seite flach / 1 Seite convex
1 side flat / 1 side convex

1 coté plat / 1 coté convex
1 lado plano / 1 lado convexo
1 lato piatto / 1 lato convesso



WILLIGER

240 mm – 9½"

28 mm Ø – 340 g

tk 24042-28

30 mm Ø – 400 g

tk 24042-30

bleigefüllt
lead filled

rempli de plomb
llenado con plomo
riempito di piombo

Hämmer
Mallets

Maillets
Martillos
Martelli



1:2

WILLIGER

165 mm – 6½"

20 mm Ø – 140 g

tk 24055-16



1:2

MEAD

170 mm – 6¾"

26 mm Ø – 320 g

tk 24050-17

Stahl massiv, mit Kunststoffbacken
Steel solid, with plastic faces

Acier solid, avec plaques en plastique
Acero solido, con placas en plastica
Acciaio massiccio, con punte di plastica

tk 24050-90

Ersatzbacken, 1 Paar
Spare faces, 1 pair

Plaques de rechange, 1 paire
Placas de cambio, 1 par
Punte di ricambio, 1 paio

Hämmer
Mallets

Maillets
Martillos
Martelli



225 mm – 8³/₄"

37 mm Ø – 370 g

tk 24052-22

Kopf massiver Stahl, mit Ferrozellbacken
Head solid steel, with Ferrozell faces

Tête acier solid, avec plaques en Ferrozell
Cabeza acero solido, con placas en Ferrozell
Testa acciaio massiccio, con punte di Ferrozell

tk 24052-90

Ersatzbacken, 1 Paar
Spare faces, 1 pair

Plaques de rechange, 1 paire
Placas de cambio, 1 par
Punte di ricambio, 1 paio



240 mm – 9¹/₂"

30 mm Ø – 480 g

tk 24059-24

Kopf massiver Stahl, mit Ferrozellstiel
Head solid steel, Ferrozell handle

Tête acier solid, manche en matière Ferrozell
Cabeza acero solido, con mango en Ferrozell
Testa acciaio massiccio, con manico di Ferrozell

Hämmer | Maillets
Mallets | Martillos
Martelli



1:2

	42 mm Ø – 250 g	42 mm Ø – 400 g
260 mm – 10¼"	tk 24045-26	tk 24046-26

Ferrozell, ohne Blei	Kunststoff, bleigefüllt
<i>Ferrozell, without lead</i>	<i>Plastic, lead filled</i>
Ferrozell, sans plomb	Matière plastique, rempli de plomb
<i>Ferrozell, sin plomo</i>	<i>Plastico, llenado con plomo</i>
Ferrozell, senza piombo	Plastica, riempito di piombo



1:2

	30 mm Ø – 450 g	50 mm Ø – 900 g
265 mm – 10½"	tk 24054-01	tk 24054-02

Knochenmeißel
Bone chisels and gouges

Ciseaux-burins, gouges
Cinceles, gubias
Scalpelli, sgorbi



1:2

185 mm – 7 1/4"

tk 24084-00

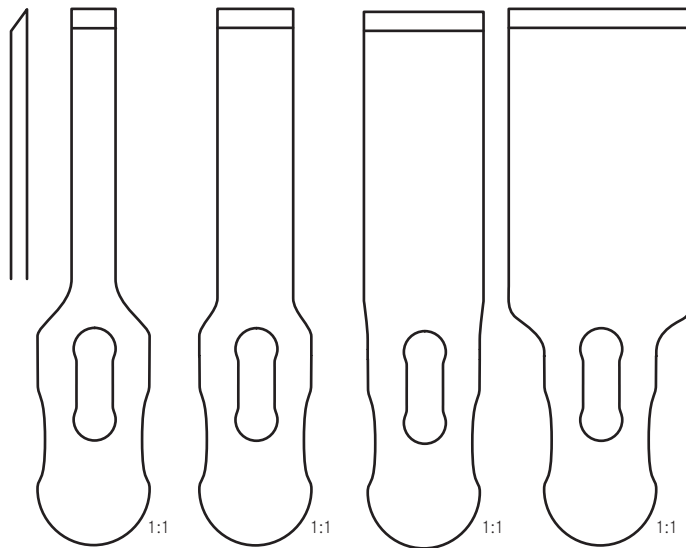

	5 mm	10 mm	16 mm	25 mm
85 mm – 3 1/4"	tk 24084-05	tk 24084-10	tk 24084-16	tk 24084-25

Meißelklingen, auswechselbar
Chisel blades, interchangeable

Lames ciseaux-burin, interchangeables
Hojas de cincel, intercambiables
Lame, intercambiabili

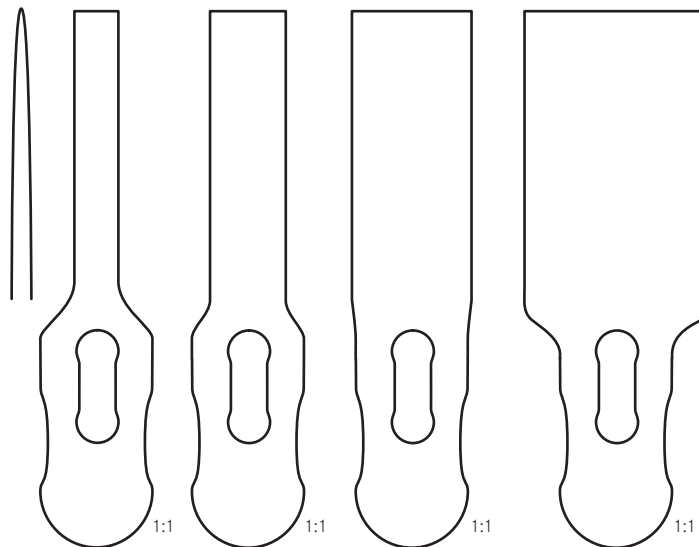

	5 mm	10 mm	16 mm	25 mm
85 mm – 3 1/4"	tk 24085-05	tk 24085-10	tk 24085-16	tk 24085-25

Osteotomklingen, auswechselbar
Osteotome blades, interchangeable

Lames d'osteotomos interchangeable
Hojas de osteótomo, intercambiables
Lame per osteotomia, intercambiabili



1:2

90 mm – 3 1/2"

tk 24084-01

Spannschlüssel
Key

Clé
Llave
Chiave

Knochenmeißel
Bone chisels and gouges

Ciseaux-burins, gouges
Cinceles, gubias
Scalpelli, sgorbi

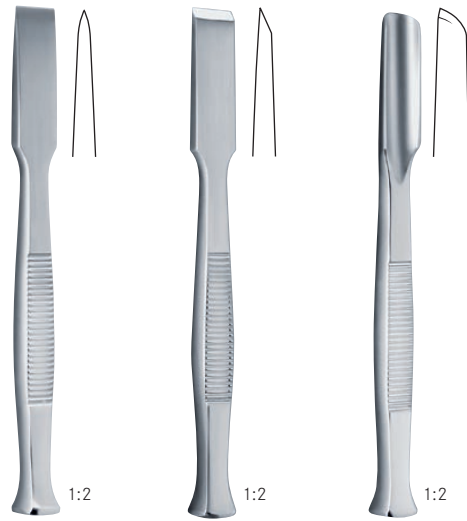

	135 mm – 5¼"	135 mm – 5¼"	135 mm – 5¼"
8 mm	tk 24060-08	tk 24062-08	tk 24064-08
10 mm	tk 24060-10	tk 24062-10	tk 24064-10
12 mm	tk 24060-12	tk 24062-12	tk 24064-12
14 mm	tk 24060-14	tk 24062-14	tk 24064-14
16 mm	tk 24060-16	tk 24062-16	tk 24064-16



LUCAS

	160 mm – 6¼"	160 mm – 6¼"
3 mm		tk 24228-03
4 mm	tk 24227-04	tk 24228-04
5 mm		tk 24228-05
6 mm	tk 24227-06	tk 24228-06

Flachmeißel <i>Chisel</i>	Hohlmeißel <i>Gouge</i>
Ciseau burin	Gouge
Cinzel	Gubia
Scalpello	Sgorbi

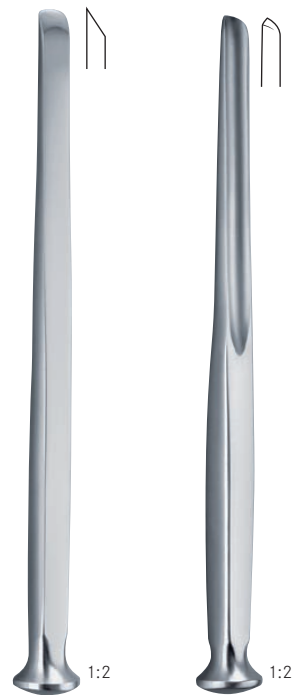

ALEXANDER

	180 mm – 7"	180 mm – 7"
4 mm	tk 24090-04	tk 24091-04
6 mm	tk 24090-06	tk 24091-06
8 mm	tk 24090-08	tk 24091-08
10 mm	tk 24090-10	tk 24091-10
12 mm	tk 24090-12	tk 24091-12
14 mm	tk 24090-14	tk 24091-14

Knochenmeißel
Bone chisels and gouges

Ciseaux-burins, gouges
Cinceles, gubias
Scalpelli, sgorbi



PARTSCH

	115 mm – 4½"	135 mm – 5¼"	170 mm – 6¾"
2 mm	tk 24111-02	tk 24113-02	tk 24117-02
3 mm	tk 24111-03	tk 24113-03	tk 24117-03
4 mm	tk 24111-04	tk 24113-04	tk 24117-04
5 mm	tk 24111-05	tk 24113-05	tk 24117-05
6 mm	tk 24111-06	tk 24113-06	tk 24117-06
7 mm	tk 24111-07	tk 24113-07	tk 24117-07
8 mm	tk 24111-08	tk 24113-08	tk 24117-08



	115 mm – 4½"	135 mm – 5¼"	170 mm – 6¾"
	tk 24211-02	tk 24213-02	tk 24217-02
	tk 24211-03	tk 24213-03	tk 24217-03
	tk 24211-04	tk 24213-04	tk 24217-04
	tk 24211-05	tk 24213-05	tk 24217-05
	tk 24211-06	tk 24213-06	tk 24217-06
	tk 24211-07	tk 24213-07	tk 24217-07
	tk 24211-08	tk 24213-08	tk 24217-08

Knochenmeißel
Bone chisels and gouges

Ciseaux-burins, gouges
Cinceles, gubias
Scalpelli, sgorbi



LAMBOTTE

	250 mm – 9¾"	250 mm – 9¾"
6 mm	tk 24092-06	tk 24093-06
8 mm	tk 24092-08	tk 24093-08
10 mm	tk 24092-10	tk 24093-10
13 mm	tk 24092-13	tk 24093-13
15 mm	tk 24092-15	tk 24093-15
20 mm	tk 24092-20	tk 24093-20
25 mm	tk 24092-25	tk 24093-25
30 mm	tk 24092-30	tk 24093-30
38 mm	tk 24092-38	tk 24093-38
44 mm	tk 24092-44	tk 24093-44
50 mm	tk 24092-50	tk 24093-50



MINI-LAMBOTTE

	125 mm – 5"	170 mm – 6¾"
3 mm	tk 24094-03	tk 24095-03
4 mm	tk 24094-04	tk 24095-04
6 mm	tk 24094-06	tk 24095-06
8 mm	tk 24094-08	tk 24095-08
10 mm	tk 24094-10	tk 24095-10
12 mm	tk 24094-12	tk 24095-12
15 mm	tk 24094-15	tk 24095-15

Knochenmeißel
Bone chisels and gouges

Ciseaux-burins, gouges
Cinceles, gubias
Scalpelli, sgorbi



LEXER

	220 mm – 8¾"	300 mm – 12"	220 mm – 8¾"	300 mm – 12"
7 mm	tk 24096-07	tk 24088-07	tk 24097-07	tk 24089-07
10 mm	tk 24096-10	tk 24088-10	tk 24097-10	tk 24089-10
15 mm	tk 24096-15	tk 24088-15	tk 24097-15	tk 24089-15
20 mm	tk 24096-20	tk 24088-20	tk 24097-20	tk 24089-20
25 mm	tk 24096-25	tk 24088-25	tk 24097-25	tk 24089-25
30 mm	tk 24096-30	tk 24088-30	tk 24097-30	tk 24089-30

Ferrozellgriff

Ferrozell handle

Manche en Ferrozell

Mango en Ferrozell

Manico di Ferrozell

MINI-LEXER

	180 mm – 7"	180 mm – 7"
4 mm	tk 24086-04	tk 24087-04
6 mm	tk 24086-06	tk 24087-06
8 mm	tk 24086-08	tk 24087-08
10 mm	tk 24086-10	tk 24087-10
12 mm	tk 24086-12	tk 24087-12

Ferrozellgriff

Ferrozell handle

Manche en Ferrozell

Mango en Ferrozell

Manico di Ferrozell

Knochenmeißel
Bone chisels and gouges

Ciseaux-burins, gouges
Cinceles, gubias
Scalpelli, sgorbi

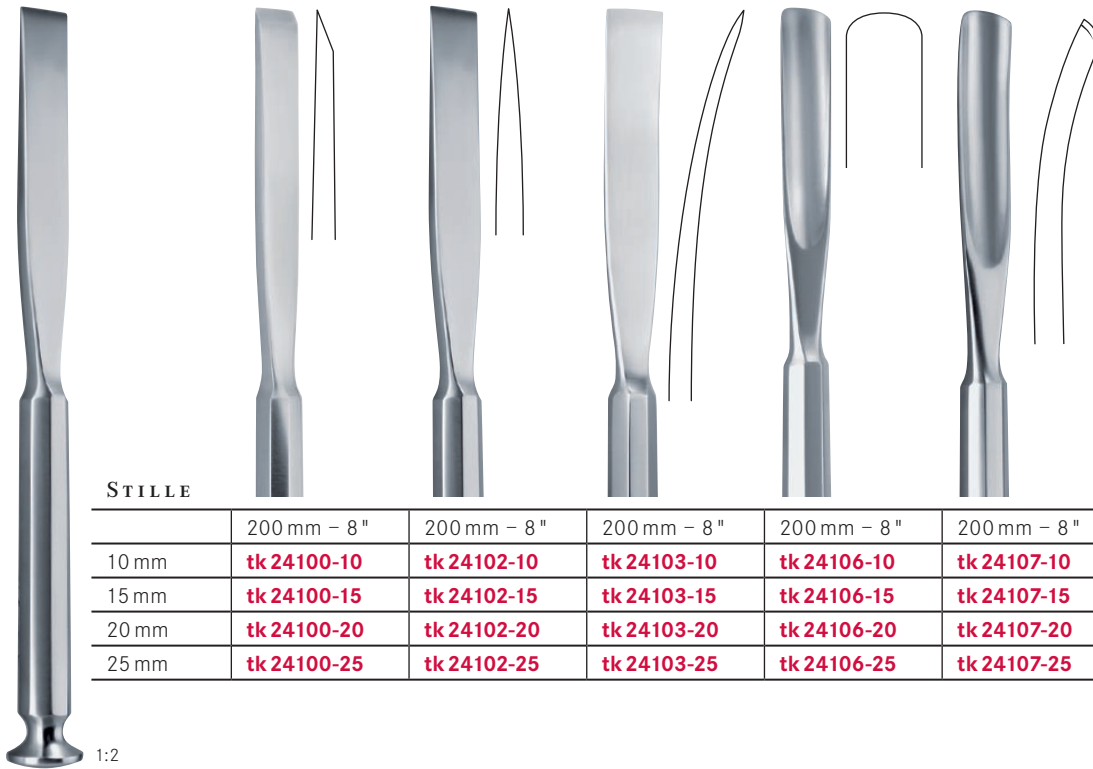

STILLE

	200 mm – 8"	200 mm – 8"	200 mm – 8"	200 mm – 8"	200 mm – 8"
10 mm	tk 24100-10	tk 24102-10	tk 24103-10	tk 24106-10	tk 24107-10
15 mm	tk 24100-15	tk 24102-15	tk 24103-15	tk 24106-15	tk 24107-15
20 mm	tk 24100-20	tk 24102-20	tk 24103-20	tk 24106-20	tk 24107-20
25 mm	tk 24100-25	tk 24102-25	tk 24103-25	tk 24106-25	tk 24107-25

1:2

Knochenmeißel
Bone chisels and gouges

Ciseaux-burins, gouges
Cinceles, gubias
Scalpelli, sgorbi

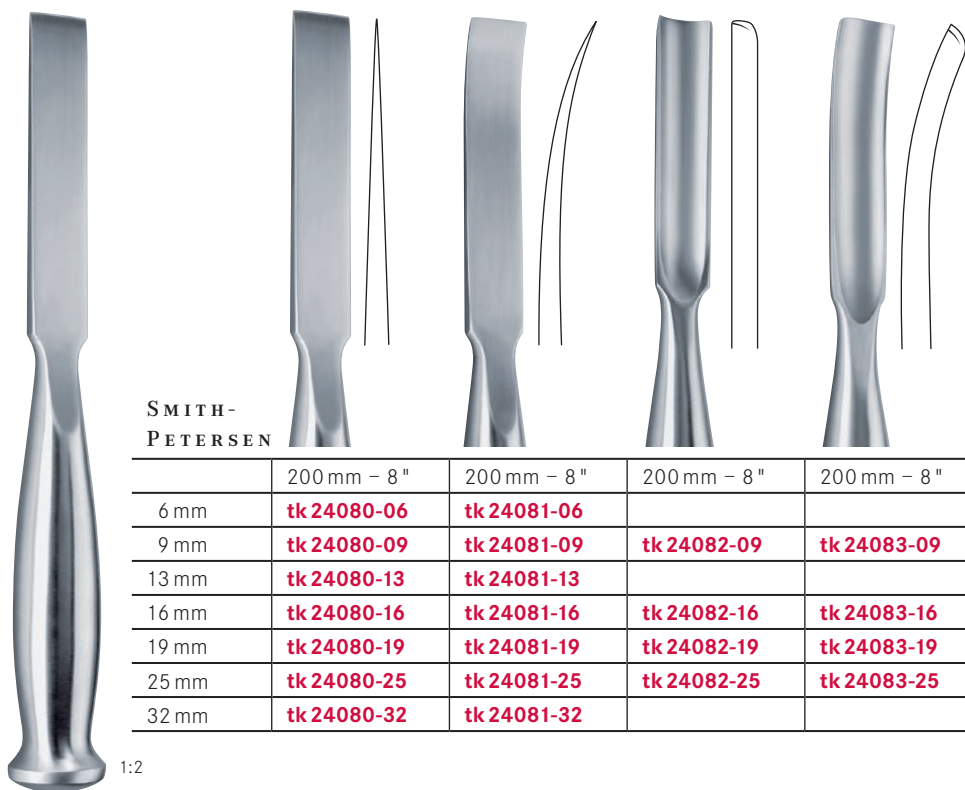

SMITH-
PETERSEN

	200 mm – 8 "	200 mm – 8 "	200 mm – 8 "	200 mm – 8 "
6 mm	tk 24080-06	tk 24081-06		
9 mm	tk 24080-09	tk 24081-09	tk 24082-09	tk 24083-09
13 mm	tk 24080-13	tk 24081-13		
16 mm	tk 24080-16	tk 24081-16	tk 24082-16	tk 24083-16
19 mm	tk 24080-19	tk 24081-19	tk 24082-19	tk 24083-19
25 mm	tk 24080-25	tk 24081-25	tk 24082-25	tk 24083-25
32 mm	tk 24080-32	tk 24081-32		

1:2

Knochenmeißel
Bone chisels and gouges

Ciseaux-burins, gouges
Cinceles, gubias
Scalpelli, sgorbi



H I B B S

	240 mm – 9½"	240 mm – 9½"	240 mm – 9½"	240 mm – 9½"	240 mm – 9½"
6 mm	tk 24221-06	tk 24222-06	tk 24223-06	tk 24224-06	tk 24225-06
13 mm	tk 24221-13	tk 24222-13	tk 24223-13	tk 24224-13	tk 24225-13
19 mm	tk 24221-19	tk 24222-19	tk 24223-19	tk 24224-19	tk 24225-19
25 mm	tk 24221-25	tk 24222-25	tk 24223-25	tk 24224-25	tk 24225-25
32 mm	tk 24221-32	tk 24222-32	tk 24223-32	tk 24224-32	tk 24225-32

1:2

Knochenmeißel
Bone chisels and gouges

Ciseaux-burins, gouges
Cinceles, gubias
Scalpelli, sgorbi

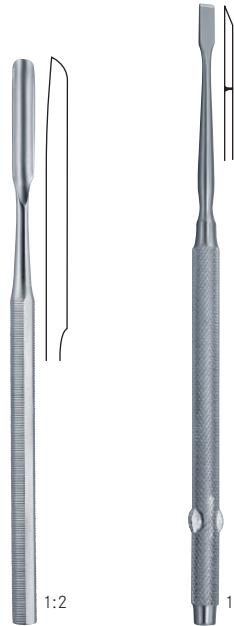

FREER	
	150 mm – 6" 160 mm – 6¼"
6 mm	tk 24251-15
4 mm	tk 24252-16

Hohlmeißel
Gouge
Gouge
Gubia
Sgorbio

Flachmeißel
Chisel
Ciseau-burin
Cinzel
Scalpello



BALLENGER	
	160 mm – 6¼"
4 mm	tk 24255-04
6 mm	tk 24255-06
8 mm	tk 24255-08



MANNERFELT MODIF.	
	155 mm – 6" 155 mm – 6"
3 mm	tk 24254-03
4 mm	tk 24253-04
6 mm	tk 24253-06
8 mm	tk 24253-08

Osteotome
Osteotomes
Ostéotomes
Osteótomos
Osteotomi

Hohlmeißel
Gouge
Gouge
Gubia
Sgorbio

Meißel zur Nasenplastik
Chisels, osteotomes for rhinoplastic

Ostéotomes, ciseaux-burins pour rhinoplastique
Cinceles para rinoplastica
Scalpelli per plastica nasale



KILIAN

1:2

160 mm – 6¼"

5 mm

tk 24261-16



KILIAN-
CLAUS

1:2

160 mm – 6¼"

5 mm

tk 24263-16



COTTLE

1:2

150 mm – 6"

7 mm

tk 24270-07

12 mm

tk 24270-12



COTTLE

1:2

190 mm – 7½"

4 mm

tk 24272-19

6 mm

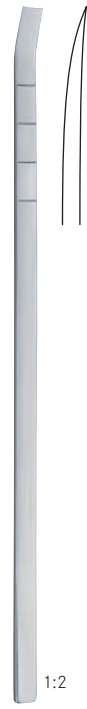

1:2

180 mm – 7"

tk 24277-06



1:2

FOMON



4 mm



5 mm



6 mm



7 mm



8 mm

170 mm – 6¾"

tk 24278-04

tk 24278-05

tk 24278-06

tk 24278-07

tk 24278-08

Meißel zur Nasenplastik
Chisels, osteotomes for rhinoplastic

Ostéotomes, ciseaux-burins pour rhinoplastique
Cinceles para rinoplastica
Scalpelli per plastica nasale



1:2

CINELLI	10 mm	12 mm	14 mm	16 mm
180 mm – 7"	tk 24279-10	tk 24279-12	tk 24279-14	tk 24279-16



1:2

COTTLE	4 mm	7 mm	9 mm	12 mm
180 mm – 7"	tk 24280-04	tk 24280-07	tk 24280-09	tk 24280-12

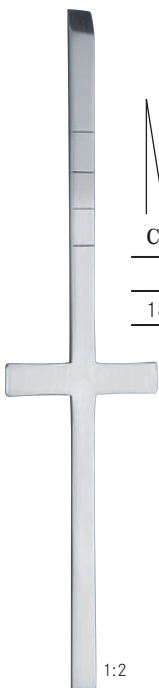

1:2

COTTLE	4 mm	7 mm	9 mm	12 mm
180 mm – 7"	tk 24281-04	tk 24281-07	tk 24281-09	tk 24281-12

Meißel zur Nasenplastik
Chisels, osteotomes for rhinoplastic

Ostéotomes, ciseaux-burins pour rhinoplastique
Cinceles para rinoplastica
Scalpelli per plastica nasale

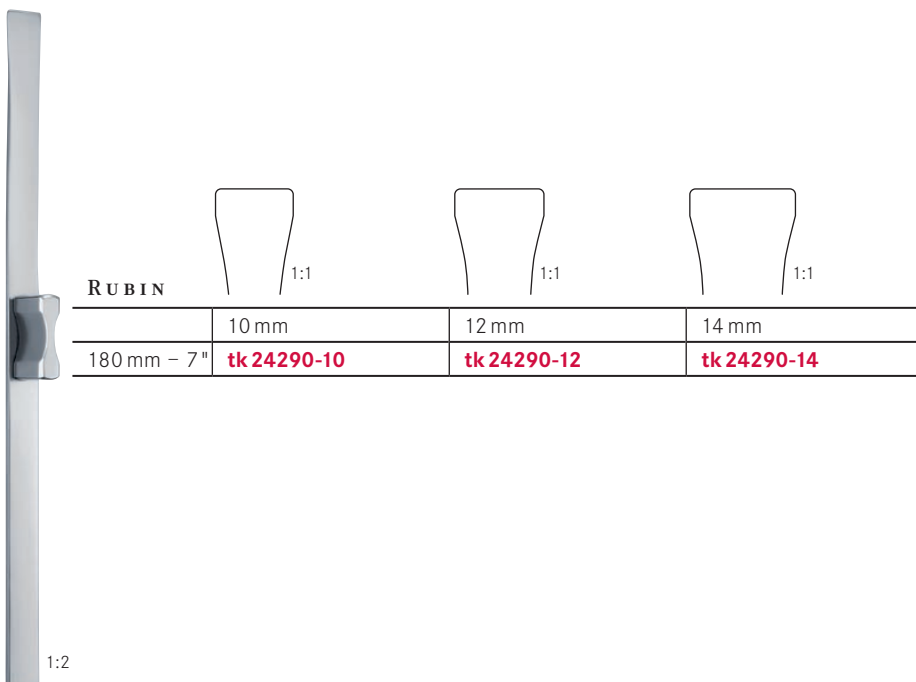
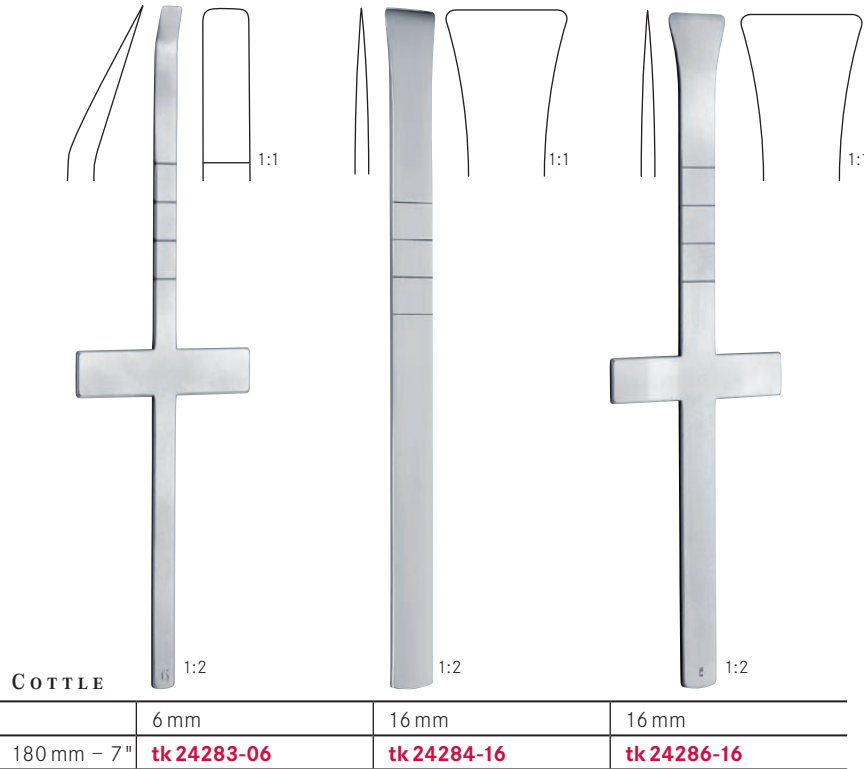





Meißel zur Nasenplastik
Chisels, osteotomes for rhinoplastic

Ostéotomes, ciseaux-burins pour rhinoplastique
Cinceles para rinoplastica
Scalpelli per plastica nasale





1:2

COTTLE				
	4 mm	7 mm	9 mm	12 mm
200 mm – 8"	tk 24287-04	tk 24287-07	tk 24287-09	tk 24287-12











1:2

WALTER		
	3 mm	4,5 mm
190 mm – 7½"	tk 24292-03	tk 24292-04



1:2

SHEEHAN				
	2 mm	4 mm	6 mm	8 mm
160 mm – 6¼"	tk 24295-02	tk 24295-04	tk 24295-06	tk 24295-08

			
10 mm	12 mm	15 mm	18 mm
tk 24295-10	tk 24295-12	tk 24295-15	tk 24295-18

Meißel zur Nasenplastik
Chisels, osteotomes for rhinoplastic

Ostéotomes, ciseaux-burins pour rhinoplastique
Cinceles para rinoplastica
ScalPELLI per plastica nasale



SILVER

180 mm – 7"

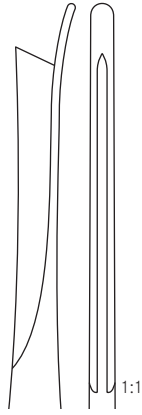

gerade
straight

droit
recta
retta

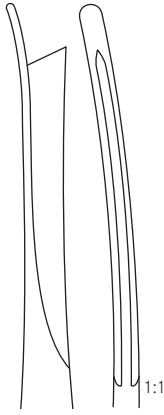

rechts
right

droite
derecha
destra

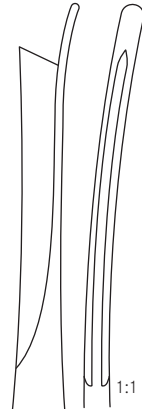

links
left

gauche
izquierda
sinistra

tk 24296-01

tk 24296-02

tk 24296-03

1:2



NEIVERT-ANDERSON

200 mm – 8"

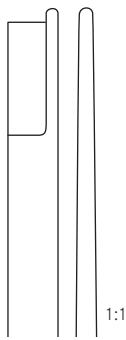

gerade
straight

droit
recta
retta

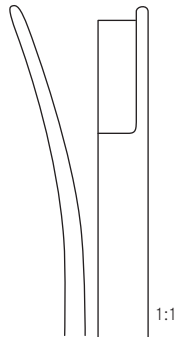

rechts
right

droite
derecha
destra

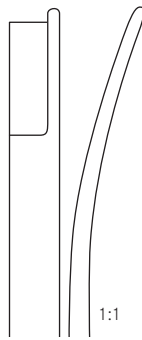

links
left

gauche
izquierda
sinistra

tk 24298-01

tk 24298-02

tk 24298-03

1:2

Meißel für die Kieferchirurgie
Osteotomes for maxillo-facial surgery

Ostéotomes pour la chirurgie maxillo-faciale
Cinceles para la cirugía maxilofacial
 Scalpelli per chirurgia massilofaciale



OBWEGESER
 235 mm – 9¼"

 11 mm

tk 52744-24



OBWEGESER	7 mm	10 mm
215 mm – 8½"	tk 52755-21	tk 52756-21

Stößel
Tampers

Pilons
Punzones
Pestoni



1:2

	1:1	1:1	1:1	1:1	1:1	1:1	1:1
	2 mm Ø	3 mm Ø	4 mm Ø	5 mm Ø	6 mm Ø	8 mm Ø	10 mm Ø
155 mm – 6"	tk 24250-02	tk 24250-03	tk 24250-04	tk 24250-05	tk 24250-06	tk 24250-08	tk 24250-10



1:2

PASSOW	1:1	1:1
	Fig. 1	Fig. 2
	2.5 mm x 2.5 mm	3.5 mm x 3.5 mm
120 mm – 4¾"	tk 24239-11	tk 24239-12



1:2

CASPAR	1:1	1:1	1:1
	3 mm Ø	5 mm Ø	8 mm Ø
200 mm – 8"	tk 24248-03	tk 24248-05	tk 24248-08







1:2





	1:1	1:1	1:1
	12 mm Ø	14 mm Ø	16 mm Ø
200 mm – 8"	tk 24249-12	tk 24249-14	tk 24249-16

Scharfe Löffel
Bone curettes

Curettes tranchantes
Cucharillas cortantes
Cucchiai taglianti









VOLKMANN	 1:1	 1:1	 1:1	 1:1	 1:1
	Fig. 0000	Fig. 000	Fig. 00	Fig. 0	Fig. 1
170 mm – 6¾"	tk 24450-40	tk 24450-30	tk 24450-20	tk 24450-10	tk 24450-01

 1:1	 1:1	 1:1	 1:1	 1:1
Fig. 2	Fig. 3	Fig. 4	Fig. 5	Fig. 6
tk 24450-02	tk 24450-03	tk 24450-04	tk 24450-05	tk 24450-06

1:2



SCHEDE	 1:1	 1:1	 1:1	 1:1	 1:1
	Fig. 000	Fig. 00	Fig. 0	Fig. 1	Fig. 2
170 mm – 6¾"	tk 24451-30	tk 24451-20	tk 24451-10	tk 24451-01	tk 24451-02



 1:1	 1:1
Fig. 3	Fig. 4
tk 24451-03	tk 24451-04



1:2



Scharfe Löffel
Bone curettes

Curettes tranchantes
Cucharillas cortantes
Cucchiai taglienti









SPRATT	 1:1	 1:1	 1:1
	Fig. 0000	Fig. 000	Fig. 00
170 mm – 6 ³ / ₄ "	tk 24461-40	tk 24461-30	tk 24461-20



 1:1	 1:1	 1:1
Fig. 0	Fig. 1	Fig. 2
tk 24461-10	tk 24461-01	tk 24461-02

 1:1	 1:1	 1:1
Fig. 3	Fig. 4	Fig. 5
tk 24461-03	tk 24461-04	tk 24461-05



BRUNS	 1:1	 1:1	 1:1
	Fig. 000	Fig. 00	Fig. 0
160 mm – 6 ¹ / ₄ "	tk 24460-30	tk 24460-20	tk 24460-10







 1:1	 1:1	 1:1
Fig. 1	Fig. 2	Fig. 3
tk 24460-01	tk 24460-02	tk 24460-03

 1:1	 1:1	 1:1
Fig. 4	Fig. 5	Fig. 6
tk 24460-04	tk 24460-05	tk 24460-06

Scharfe Löffel
Bone curettes

Curettes tranchantes
Cucharillas cortantes
Cucchiai taglianti



VOLKMANN	 1:1	 1:1	 1:1	 1:1	 1:1	 1:1
	Fig. 0000	Fig. 000	Fig. 00	Fig. 0	Fig. 1	Fig. 2
185 mm – 7¼"	tk 24442-40	tk 24442-30	tk 24442-20	tk 24442-10	tk 24442-01	tk 24442-02





oval, mit Kunststoffgriff





oval, with plastic handle

ovale, avec manche en matière plastique

ovalada, con mango plástico

ovale, con manico in plastica

	 1:1	 1:1	 1:1	 1:1
	Fig. 3	Fig. 4	Fig. 5	Fig. 6
190 mm – 7½"	tk 24442-03	tk 24442-04	tk 24442-05	tk 24442-06

	 1:1	 1:1	 1:1	 1:1	 1:1
	Fig. 0	Fig. 1	Fig. 2	Fig. 3	Fig. 4
275 mm – 10¾"	tk 24443-00	tk 24443-01	tk 24443-02	tk 24443-03	tk 24443-04

Scharfe Löffel
Bone curettes

Curettes tranchantes
Cucharillas cortantes
Cucchiai taglienti



HALLER



	Fig. 1	Fig. 2	Fig. 3
210 mm – 8 ³ / ₄ "	tk 24462-01	tk 24462-02	tk 24462-03

flexibel
flexible
flexible
flexible
flessibile

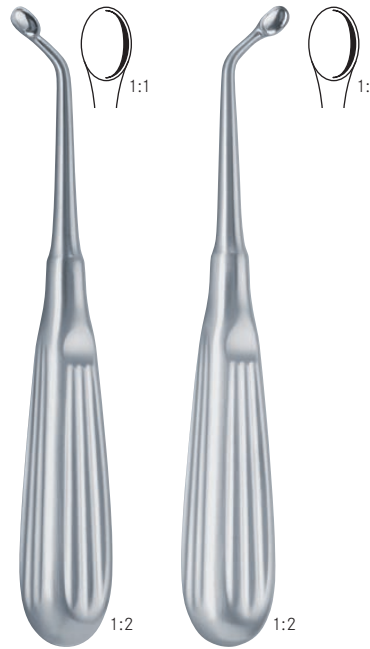

UFFENORDE

	Fig. 1	Fig. 2
170 mm – 6 ³ / ₄ "	tk 24463-01	tk 24463-02



BRUNS



	Fig. 00	Fig. 0	Fig. 1	Fig. 2
230 mm – 9 "	tk 24464-20	tk 24464-10	tk 24464-01	tk 24464-02

massiv
solid
solide
macizo
massiccio



Fig. 3	Fig. 4	Fig. 5	Fig. 6
tk 24464-03	tk 24464-04	tk 24464-05	tk 24464-06

Scharfe Löffel
Bone curettes

Curettes tranchantes
Cucharillas cortantes
Cucchiai taglianti



SCHROEDER



	Fig. 1	Fig. 2	Fig. 3
300 mm – 12"	tk 24448-01	tk 24448-02	tk 24448-03

scharf / fest
sharp / rigid

tranchante / rigide
cortante / rigida
tagliante / rigido

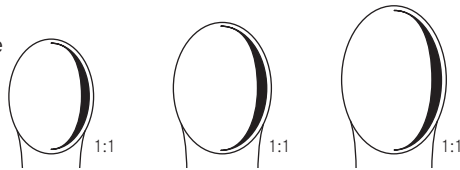

	Fig. 4	Fig. 5	Fig. 6
	tk 24448-04	tk 24448-05	tk 24448-06

1:2



1:2

SIMON



	Fig. 0000	Fig. 000	Fig. 00	Fig. 0
240 mm – 9½"	tk 24440-40	tk 24440-30	tk 24440-20	tk 24440-10

scharf / fest
sharp / rigid

tranchante / rigide
cortante / rigida
tagliante / rigido

SIMON

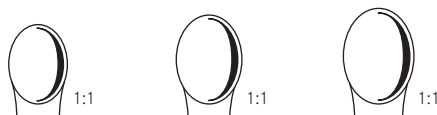

	Fig. 1	Fig. 2	Fig. 3
250 mm – 9¾"	tk 24445-01	tk 24445-02	tk 24445-03

scharf / fest
sharp / rigid

tranchante / rigide
cortante / rigida
tagliante / rigido

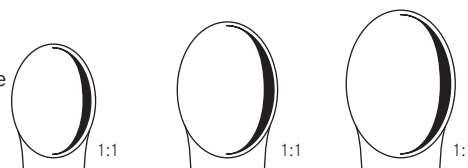





	Fig. 4	Fig. 5	Fig. 6
	tk 24445-04	tk 24445-05	tk 24445-06

Scharfe Löffel
Bone curettes



Curettes tranchantes
Cucharillas cortantes
Cucchiai taglienti





1:2

	 1:1	 1:1	 1:1
	Fig. 000	Fig. 00	Fig. 0
200 mm – 8 "	tk 24390-30	tk 24390-20	tk 24390-10



gerade
straight
droit
recta
retto

 1:1	 1:1	 1:1
Fig. 1	Fig. 2	Fig. 3
tk 24390-01	tk 24390-02	tk 24390-03



 1:1	 1:1	 1:1
Fig. 4	Fig. 5	Fig. 6
tk 24390-04	tk 24390-05	tk 24390-06





1:2

	 1:1	 1:1	 1:1
	Fig. 000	Fig. 00	Fig. 0
200 mm – 8 "	tk 24391-30	tk 24391-20	tk 24391-10

gebogen
curved
courbe
curva
curvo

 1:1	 1:1	 1:1
Fig. 1	Fig. 2	Fig. 3
tk 24391-01	tk 24391-02	tk 24391-03

 1:1	 1:1	 1:1
Fig. 4	Fig. 5	Fig. 6
tk 24391-04	tk 24391-05	tk 24391-06

Scharfe Löffel
Bone currettes

Curettes tranchantes
Cucharillas cortantes
Cucchiai taglienti



1:2



1:1



1:1



1:1



1:1

	Fig. 000	Fig. 00	Fig. 0	Fig. 1
	3.6 mm	4.4 mm	5.2 mm	6.8 mm
250 mm – 9 3/4"	tk 24392-30	tk 24392-20	tk 24392-10	tk 24392-01

gerade
straight
droit
recta
retto



1:2

DAUBENSPECK



1:1



1:1



1:1



1:1

	Fig. 0000	Fig. 000	Fig. 00	Fig. 0
	2.8 mm	3.6 mm	4.4 mm	5.2 mm
200 mm – 8"	tk 24394-40	tk 24394-30	tk 24394-20	tk 24394-10

Scharfe Löffel
Bone curettes

Curettes tranchantes
Cucharillas cortantes
Cucchiai taglienti







1:2

SCOVILLE	 1:1	 1:1	 1:1
	Fig. 1	Fig. 2	Fig. 3
250 mm – 9 3/4"	tk 24465-01	tk 24465-02	tk 24465-03

oval
oval
ovale
ovalada
ovale



1:2

LEMPERT	 1:1	 1:1	 1:1	 1:1	 1:1
	Fig. 00000	Fig. 0000	Fig. 000	Fig. 00	Fig. 0
	1.8 mm	2.0 mm	2.4 mm	2.6 mm	2.8 mm
215 mm – 8 1/2"	tk 24395-50	tk 24395-40	tk 24395-30	tk 24395-20	tk 24395-10

Scharfe Doppellöffel
Bone curettes, double-ended

Curettes doubles
Cucharillas de doble extremo
Curette doppia

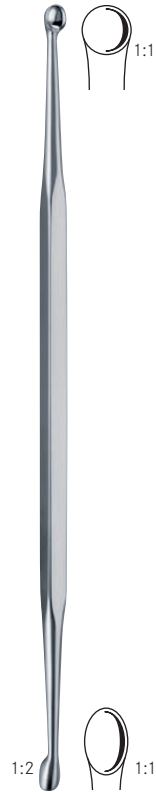

VOLKMANN

130 mm – 5"	tk 24400-13	tk 24410-13
140 mm – 5½"	tk 24400-14	
160 mm – 6¼"		tk 24410-16
170 mm – 6¾"	tk 24400-17	
200 mm – 8"		tk 24410-20

oval / oval
oval / oval
ovale / ovale
ovalada / ovalada
ovale / ovale



rund / oval
round / oval
ronde / ovale
redonda / ovalada
rotondo / ovale

210 mm – 8¼"
tk 24412-21
rund / oval
round / oval
ronde / ovale
redonda / ovalada
rotondo / ovale

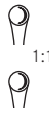

Scharfe Doppellöffel
Bone curettes, double-ended

Curettes doubles
Cucharillas de doble extremo
Curette doppia



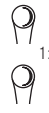

MARTINI			
	 1:1	 1:1	 1:1
	Fig. 00	Fig. 0	Fig. 1
	Fig. 0	Fig. 1	Fig. 2
135 mm – 5¼"	tk 24485-00	tk 24485-01	tk 24485-12





MARTINI			
	 1:1	 1:1	 1:1
	Fig. 00	Fig. 0	Fig. 1
	Fig. 00	Fig. 0	Fig. 1
155 mm – 6"	tk 24489-20	tk 24489-10	tk 24489-01



WILLIGER			
	 1:1	 1:1	 1:1
	Fig. 00	Fig. 0	Fig. 1
	Fig. 0	Fig. 1	Fig. 2
135 mm – 5¼"	tk 24487-00	tk 24487-01	tk 24487-12

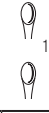

WILLIGER			
	 1:1	 1:1	 1:1
	Fig. 00	Fig. 0	Fig. 1
	Fig. 00	Fig. 0	Fig. 1
155 mm – 6"	tk 24490-20	tk 24490-10	tk 24490-01

Raspatorien für die Kieferchirurgie
Periosteal elevators for maxillo-facial surgery

Rugines – Décolleurs pour la chirurgie maxillo-faciale
Periostótomos para la cirugía maxilofacial
 Raspatori per chirurgia massilofaciale



Raspatorien und Ahlen für die Kieferchirurgie
Periosteal elevators and awls for maxillo-facial surgery

Rugines, décolleurs et passe-fils pour chirurgie maxillo-faciale
Periostótomos y leznas para la cirugía maxilofacial
Raspatori, punteruoli per chirurgia massilofaciale

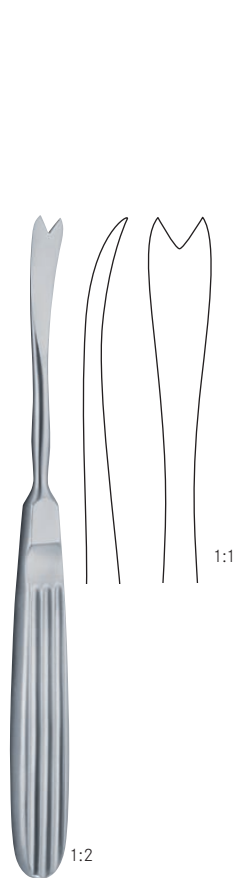

OBWEGESER

175 mm – 7"

tk 52735-01



OBWEGESER

230 mm – 9"

tk 52751-23



OBWEGESER

180 mm – 7"

tk 52749-18



OBWEGESER

140 mm – 5½"

tk 52750-14

Raspatorien – Elevatorien
Periosteal raspatories – Elevators

Rugines – Elevateurs
Raspatorios – Elevadores
 Periostotomi – Elevatori



DOYEN

170 mm – 6¾" "

links
left
 gauche
izquierda
 sinistra

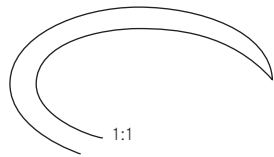

1:1

tk 24500-17

für Erwachsene
for adults
 pour adultes
para adultos
 per adulti

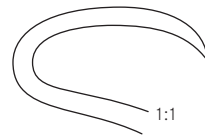

1:1

tk 24510-17

für Kinder
for children
 pour enfants
para niños
 per bambini

1:2



DOYEN

170 mm – 6¾" "

rechts
right
 droite
derecha
 destra

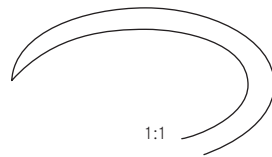

1:1

tk 24501-17

für Erwachsene
for adults
 pour adultes
para adultos
 per adulti

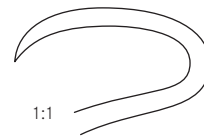

1:1

tk 24511-17

für Kinder
for children
 pour enfants
para niños
 per bambini

1:2

Raspatorien – Elevatorien
Periosteal raspatories – Elevators

Rugines – Elevateurs
Raspatorios – Elevadores
Periostotomi – Elevatori

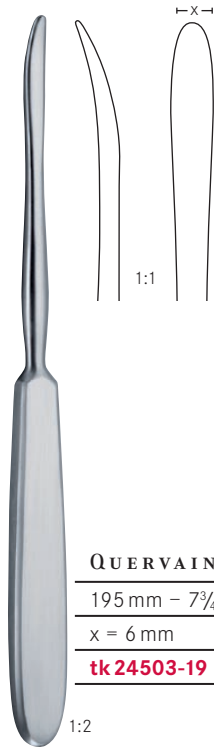

QUERVAIN

195 mm – 7³/₄ "

x = 6 mm

tk 24503-19

1:2

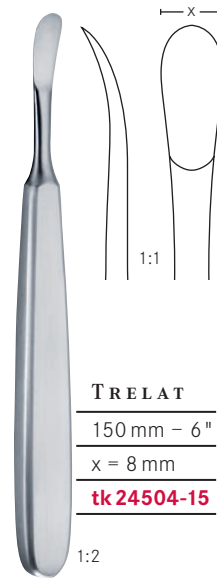

TRELAT

150 mm – 6 "

x = 8 mm

tk 24504-15

1:2

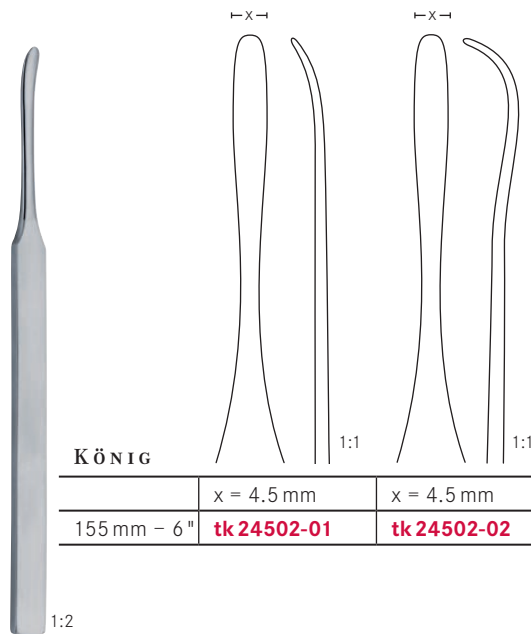

KÖNIG

x = 4.5 mm

x = 4.5 mm

155 mm – 6 "

tk 24502-01

tk 24502-02

1:2

Raspatorien – Elevatorien
 Periosteal raspatories – Elevators

Rugines – Elevateurs
 Raspatorios – Elevadores
 Periostotomi – Elevatori

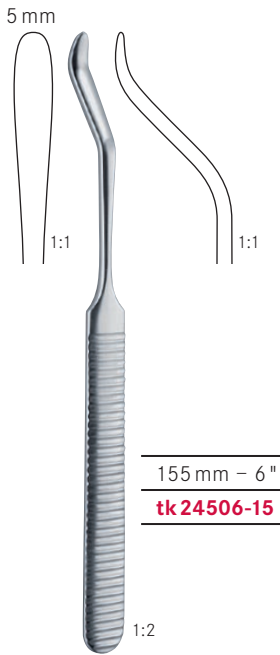

155 mm – 6"
tk 24506-15

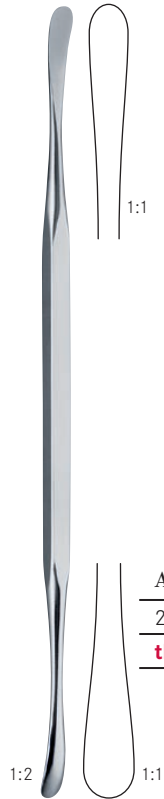

ALDERDYCE
 210 mm – 8¼"
tk 24518-21

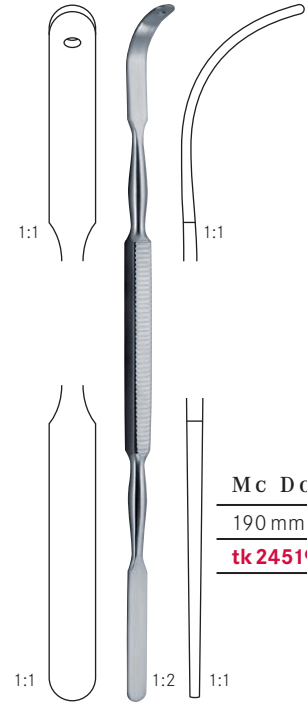

MC DONALD
 190 mm – 7½"
tk 24519-19

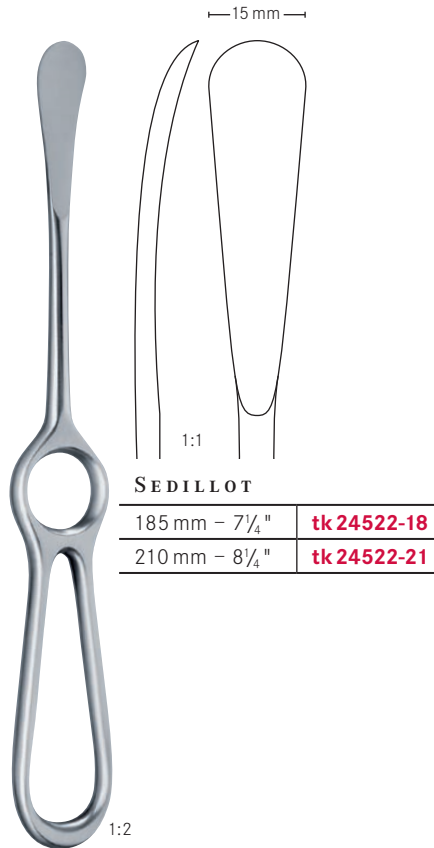

SEDILLOT
 185 mm – 7¼" **tk 24522-18**
 210 mm – 8¼" **tk 24522-21**



WATSON-CHEYNE
 190 mm – 7½"
tk 24529-19

Raspatorien – Elevatorien
Periosteal raspatories – Elevators

Rugines – Elevateurs
Raspatorios – Elevadores
 Periostotomi – Elevatori

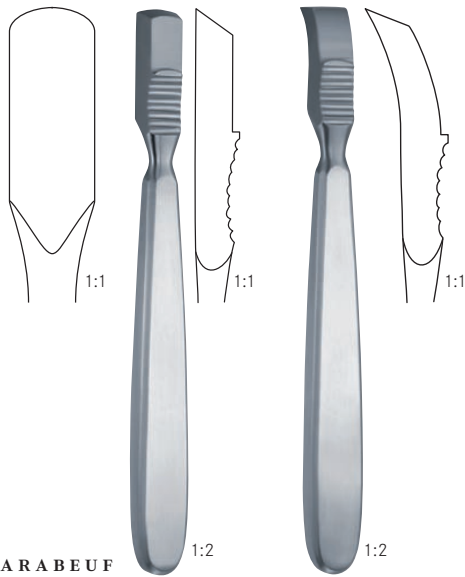

FARABEU F	
150 mm – 6"	tk 24520-15 tk 24521-15
gerade <i>straight</i>	gebogen <i>curved</i>
droit <i>recta</i>	courbe <i>curva</i>
retto	curvo

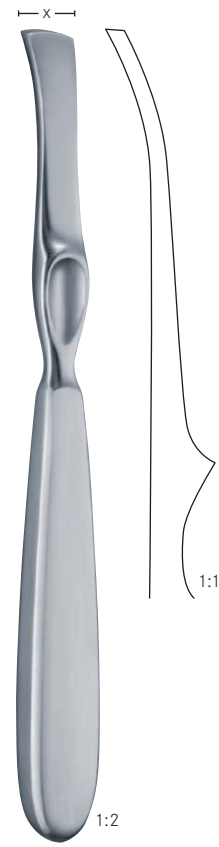

LAMBOTTE	
	210 mm – 8¼"
x = 5 mm	tk 24523-05
x = 10 mm	tk 24523-10
x = 15 mm	tk 24523-15
x = 20 mm	tk 24523-20
x = 25 mm	tk 24523-25

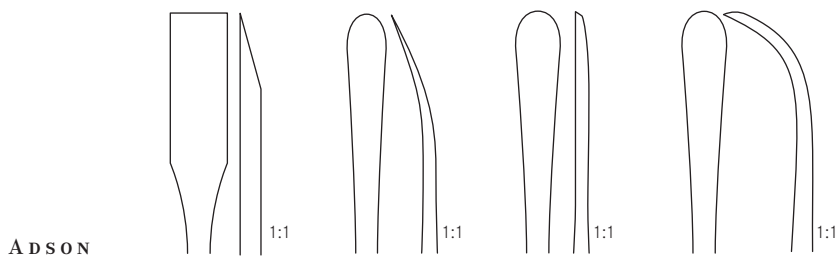

ADSON	Fig. 1	Fig. 2	Fig. 3	Fig. 4
170 mm – 6¾"	tk 24535-01	tk 24535-02	tk 24535-03	tk 24535-04

Raspatorien – Elevatorien
 Periosteal raspatories – Elevators

Rugines – Elevateurs
 Raspatorios – Elevadores
 Periostotomi – Elevatori

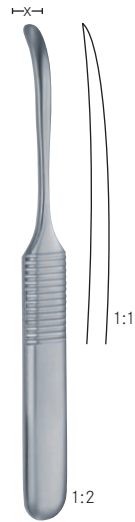

WILLIGER
 x = 5 mm
 130 mm – 5" **tk 24525-13**

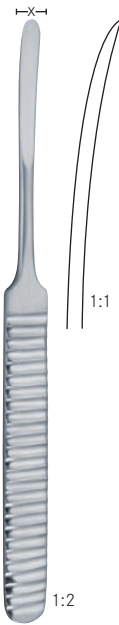

WILLIGER
 160 mm – 6¼"
 x = 4 mm **tk 24525-16**
 x = 6 mm **tk 24526-16**



WILLIGER
 x = 5 mm
 160 mm – 6¼" **tk 24532-16**



x = 6.5 mm
tk 24533-17



FARABEUF-COLLIN
 x = 11 mm
 160 mm – 6¼" **tk 24528-01**



x = 11 mm
tk 24528-02

Raspatorien – Elevatorien
Periosteal raspatories – Elevators

Rugines – Elevateurs
Raspatorios – Elevadores
Periostotomi – Elevatori



OBWEGESER

	2.5 mm	4 mm
150 mm – 6"	tk 52742-25	tk 52742-40



OBWEGESER

185 mm – 7 1/4"
tk 52746-19



OBWEGESER

185 mm – 7 1/4"
tk 52747-19

Raspatorien – Elevatorien
 Periosteal raspatories – Elevators

Rugines – Elevateurs
 Raspatorios – Elevadores
 Periostotomi – Elevatori



SEMB	 1:2	 1:2	 1:2	 1:2	 1:2	 1:2
	175 mm – 7"	210 mm – 8¼"	175 mm – 7"	210 mm – 8¼"	225 mm – 8¾"	220 mm – 8¾"
	12 mm	12 mm	13 mm	13 mm	13 mm	15 mm
	tk 24536-01	tk 24536-02	tk 24536-03	tk 24536-04	tk 24536-05	tk 24536-06

Raspatorien – Elevatorien
Periosteal raspatories – Elevators

Rugines – Elevateurs
Raspatorios – Elevadores
Periostotomi – Elevatori



HOWARTH

215 mm – 8½"

tk 24534-21

scharf / stumpf
sharp / blunt
pointu / mousse
aguda / roma
acuta / smussa



**LANGEN-
BECK**

180 mm – 7"

tk 24537-18

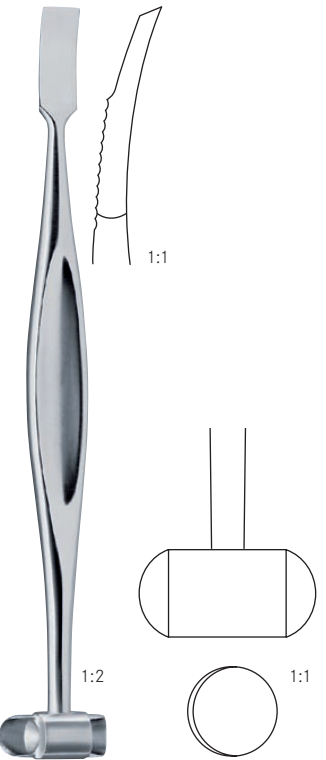
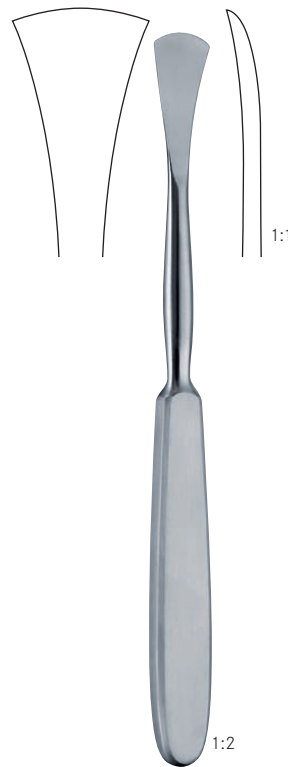

ALEXANDER

200 mm – 8"

tk 24539-20

Raspatorien – Elevatorien
Periosteal raspatories – Elevators

Rugines – Elevateurs
Raspatorios – Elevadores
 Periostotomi – Elevatori



LANGENBECK

	x = 8 mm	x = 10 mm
200 mm – 8"	tk 24540-20	tk 24542-20

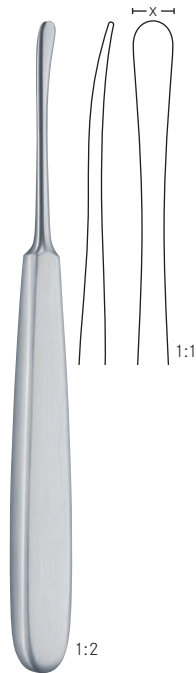

SEBILEAU

	x = 5 mm
175 mm – 7"	tk 24544-17

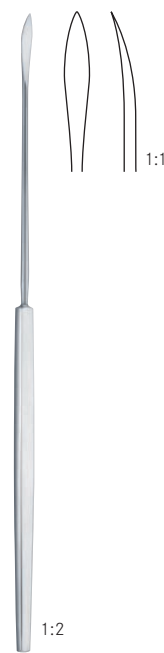

175 mm – 7"	tk 24546-17
-------------	--------------------

extrem leicht
extremely light
 extrêmement léger
 extremamente ligero
 estremamente leggera

Raspatorien – Elevatorien
Periosteal raspatories – Elevators

Rugines – Elevateurs
Raspatorios – Elevadores
Periostotomi – Elevatori

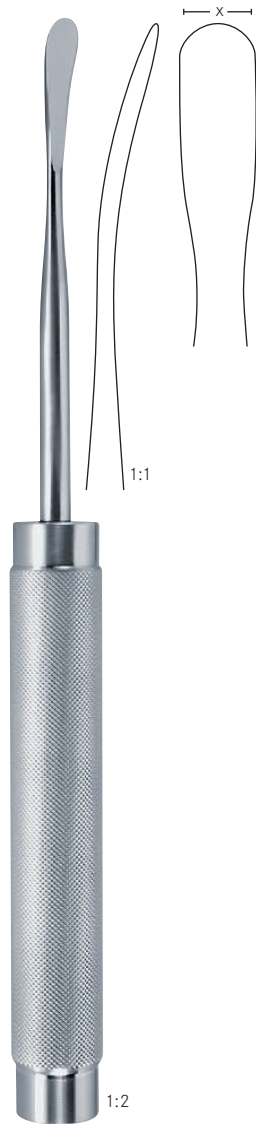

COBB	290 mm – 11½"
x = 10 mm	tk 24541-10
x = 13 mm	tk 24541-13
x = 19 mm	tk 24541-19

Wirbelsäulen-Raspatorium
Spinal raspatory
Rugine vertebral
Raspatorio vertebral
Periostotomo vertebrale



KEY	180 mm – 7"	190 mm – 7½"	190 mm – 7½"
	x = 6 mm	x = 10 mm	x = 12 mm
	tk 24545-06	tk 24545-10	tk 24545-12

200 mm – 8"	210 mm – 8¼"
x = 19 mm	x = 25 mm
tk 24545-19	tk 24545-25

Raspatorien
Periosteal raspatories

Rugines
Raspatorios
 Periostotomi

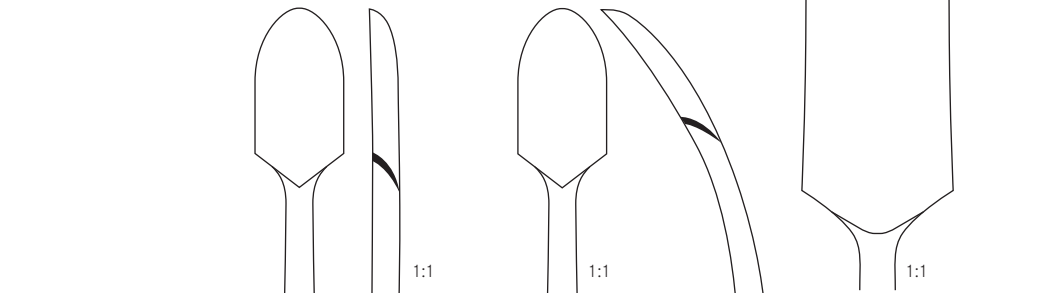

	Fig. 1	Fig. 2	Fig. 3
	14 mm	14 mm	20 mm
200 mm – 8"	tk 24548-01	tk 24548-02	tk 24548-03
Ferrozellgriff <i>Ferrozell handle</i>	gerade <i>straight</i>	gebogen <i>curved</i>	gerade <i>straight</i>
Manche en Ferrozell <i>Mango en Ferrozell</i>	droit <i>recta</i>	courbe <i>curva</i>	droit <i>recta</i>
Manico di Ferrozell	rette	curve	rette

1:2

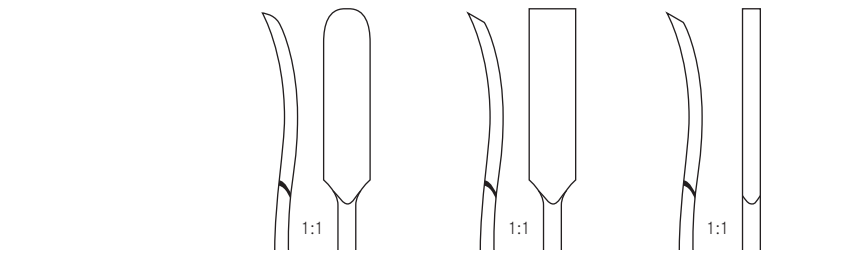

	Fig. 1	Fig. 2	Fig. 3
	6 mm	3 mm	6 mm
180 mm – 7"	tk 24549-01	tk 24549-02	tk 24549-03

Ferrozellgriff
Ferrozell handle
 Manche en Ferrozell
Mango en Ferrozell
 Manico di Ferrozell

1:2

Knochenhebel
Bone levers

Leviers à os
Elevadores para huesos
Elevatori per ossa



HOHMANN

220 mm – 8¾"	240 mm – 9½"	240 mm – 9½"	240 mm – 9½"
x = 8 mm	x = 18 mm	x = 43 mm	x = 70 mm
tk 24550-08	tk 24550-18	tk 24550-43	tk 24550-70

Knochenhebel
Bone levers

Leviers à os
Elevadores para huesos
Elevatori per ossa



HOHMANN

245 mm – 9¾"	260 mm – 10¼"	280 mm – 11"	265 mm – 10½"	260 mm – 10¼"
x = 43 mm	x = 22 mm	x = 33 mm	x = 24 mm	x = 22 mm
tk 24558-43	tk 24558-22	tk 24558-33	tk 24559-24	tk 24561-22

Knochenhebel
Bone levers

Leviers à os
Elevadores para huesos
Elevatori per ossa

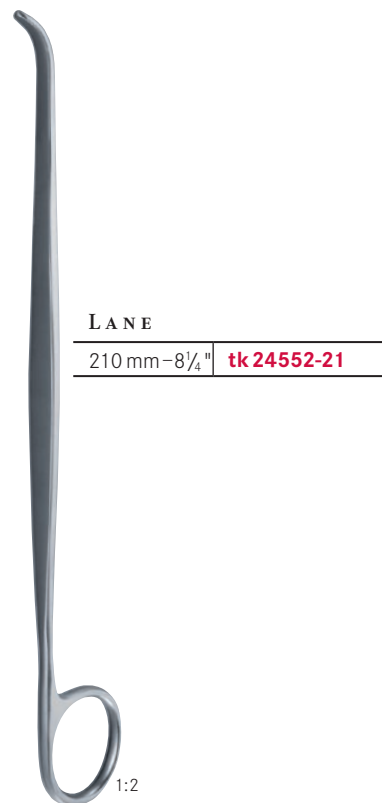
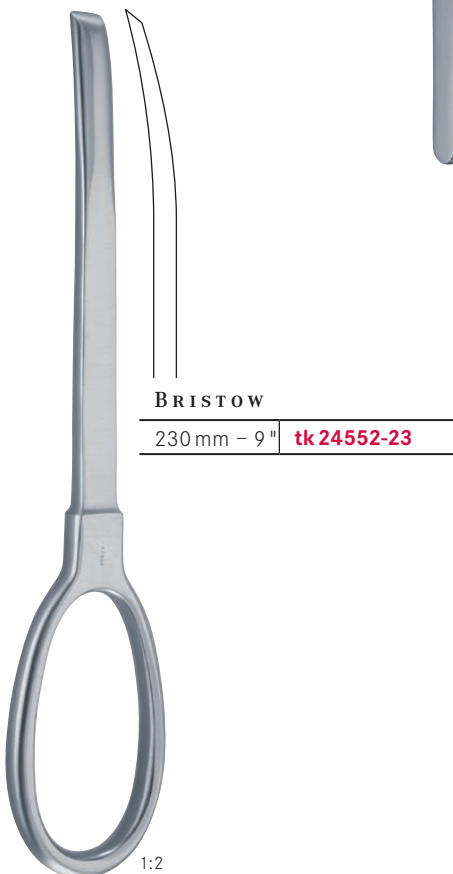
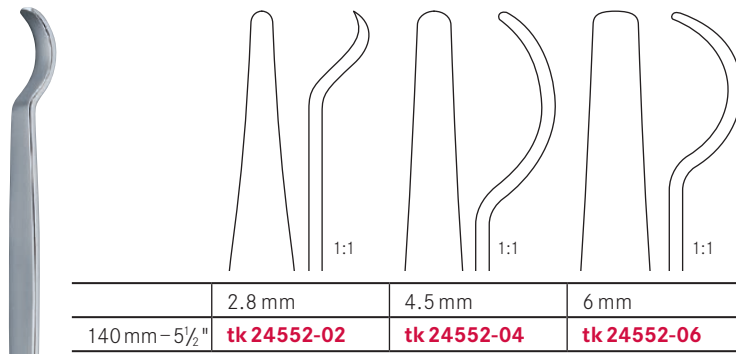
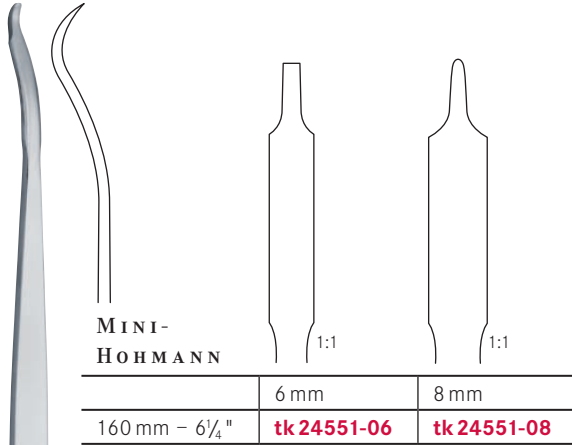

Knochenhebel
Bone levers

Leviers à os
Elevadores para huesos
Elevatori per ossa



BENNETT

	240 mm – 9½"
x = 43 mm	tk 24555-01
x = 60 mm	tk 24555-02

1:2



MURPHY-LANE

	340 mm – 13½"
	tk 24556-34

Luxationshebel
Luxation lever

Levier de luxation
Palanca de luxación
Leva per luxazione

1:2

← 18 mm →

Knochenhebel
Bone levers

Leviers à os
Elevadores para huesos
Elevatori per ossa



BLOUNT

1:2

1:2

260 mm – 10 $\frac{1}{4}$ "	tk 24562-26	tk 24563-26
-----------------------------	--------------------	--------------------



**LANGE-
HOHMANN MOD.**

265 mm – 10 $\frac{1}{2}$ "	280 mm – 11"
x = 30 mm	x = 33 mm
tk 24561-26	tk 24561-28

Knochenhebel
Bone levers

Leviers à os
Elevadores para huesos
Elevatori per ossa



**HOHMANN-
WILLIGER**

160 mm – 6¼"

tk 24560-16

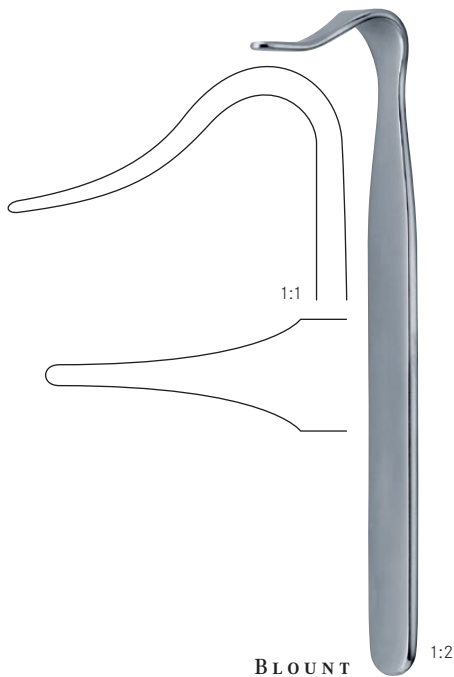

BLOUNT

175 mm – 7"

tk 24564-17



TAYLOR

a = 75 mm – b = 30 mm	165 mm – 6½"
a = 100 mm – b = 30 mm	tk 24566-16
	tk 24567-16

Meniskotome
Meniscotomy knives

Bistouries à ménisques
Bisturías para meniscos
Bisturi per menisco



BIRCHER

190 mm – 7½"

tk 24563-19

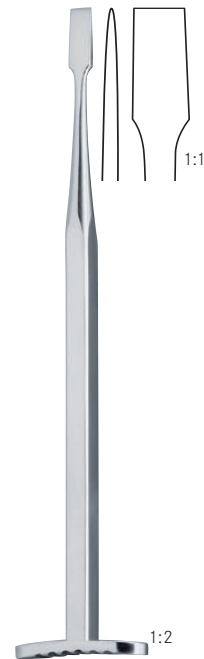

SMILLIE

170 mm – 6¾"

tk 24568-17



tk 24569-17



tk 24570-17

Meniskotome
Meniscotomy knives

Bistouries à ménisques
Bisturías para meniscos
Bisturi per menisco

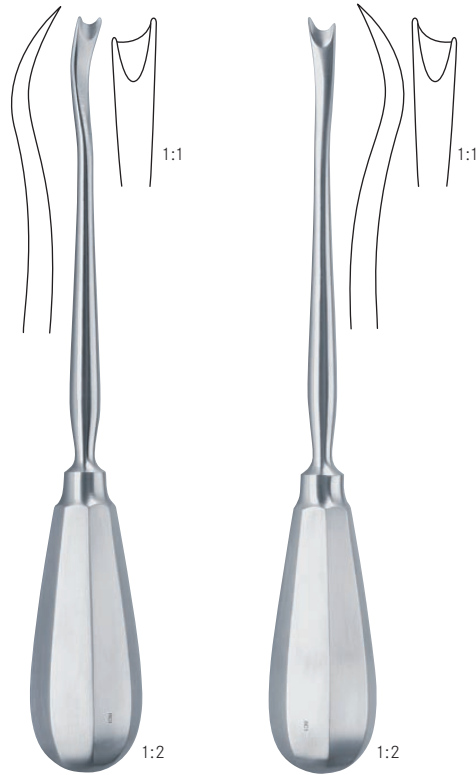

KANADISCHES
MODELL

	Fig. 1	Fig. 2
200 mm – 8"	tk 24571-01	tk 24571-02

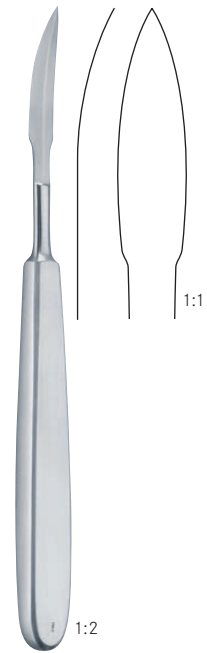

180 mm – 7"
tk 24573-18



1:2

NEFF

220 mm – 8 ³ / ₄ "	tk 24572-01	tk 24572-02
--	--------------------	--------------------

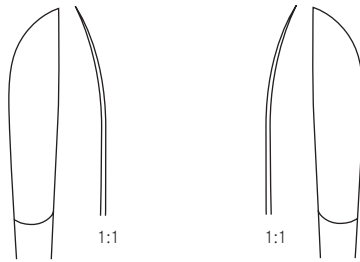



links
left
gauche
izquierda
sinistra

rechts
right
droit
derecha
destra

Sehnenstripper
Tendon strippers

Instrumente à écorcher les tendons
Enucleadores de tendones
Scollatendini







	 1:1	 1:1	 1:1
	4.0 mm Ø	4.5 mm Ø	5.5 mm Ø
230 mm – 9"	tk 24578-40	tk 24578-45	tk 24578-55

Schaft biegsam
Malleable shaft
Tige malléable
Tija maleable
Asta malleabile

1:2



BUNNELL	 1:1	 1:1	 1:1
	Fig. 1	Fig. 2	Fig. 3
150 mm – 6"	tk 24575-01	tk 24575-02	tk 24575-03

 1:1	 1:1
Fig. 4	Fig. 5
tk 24575-04	tk 24575-05

1:2

Sehnenstripper
Tendon strippers

Instruments à écorcher les tendons
Enucleadores de tendones
Scollatendini



FISCHER
310 mm – 12¼"
tk 24580-31



BUNNELL
230 mm – 9"
tk 24582-23





**KLEINERT-
KUTZ**
200 mm – 8"
20 mm Ø
tk 24588-20

Sehnedurchzugs-sonde
Tendon passer
Sonde conductrice pour tendons
Sonda conductora de tendones
Sonda conduttrice per tendini

Sehnenfazzangen
Tendon holding forceps

Pinces pour saisir les tendons
Pinzas para coger tendones
Pinze per afferrare tendini



BRAND	 1:1	 1:1	 1:1
	150 mm – 6"	190 mm – 7½"	240 mm – 9½"
	tk 24585-15	tk 24585-19	tk 24585-24

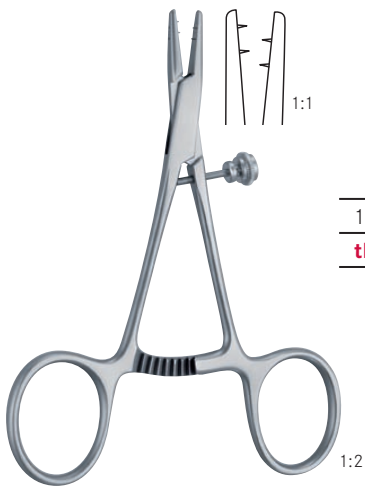

 1:1
130 mm – 5"
tk 38724-13



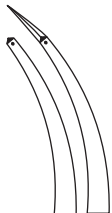

 1:1	 1:1
150 mm – 6"	tk 24589-15
	tk 24590-15

Hohlmeißelzangen
Bone rongeurs

Pinces gouges
Pinzas gubias
Pinze sgorbie



LUER		
	Fig. 1	Fig. 2
150 mm – 6"	tk 24601-15	tk 24602-15

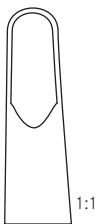
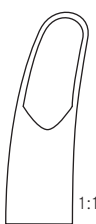

LUER		
	Fig. 1	Fig. 2
170 mm – 6¾"	tk 24603-17	tk 24604-17



	MINI-FRIEDMANN
	120 mm – 4¾"
	tk 24605-12





	FRIEDMANN
	140 mm – 5½"
	tk 24605-14

Hohlmeißelzangen
Bone rongeurs

Pinces gouges
Pinzas gubias
Pinze sgorbie

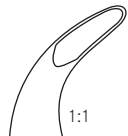

BLUMENTHAL			
	 1:1	 1:1	 1:1
	Fig. 1	Fig. 2	Fig. 3
155 mm – 6"	tk 24606-01	tk 24606-02	tk 24606-03

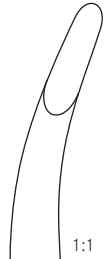

JANSEN		
	 1:1	 1:1
	Fig. 1	Fig. 2
180 mm – 7"	tk 24607-01	tk 24607-02

Hohlmeißelzangen
Bone rongeurs

Pinces gouges
Pinzas gubias
Pinze sgorbie



JANSEN
190 mm – 7½"

tk 24608-19



ADSON
200 mm – 8"

tk 24609-20



BACON
210 mm – 8¼"

tk 24610-21

Hohlmeißelzangen
Bone rongeurs

Pinces gouges
Pinzas gubias
Pinze sgorbie



LEMPERT

190 mm – 7½"

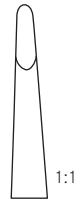

1:1

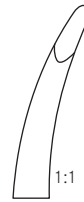

1:1

tk 24612-19

tk 24611-19

1:2



STELLBRINK

175 mm – 7"



1:1

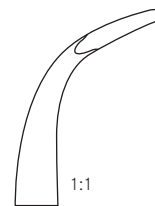

1:1

tk 24614-01

tk 24614-02

leicht gebogen

slightly curved

légèrement courbe

ligeramente curvada

legermente curvata

stark gebogen

strongly curved

très courbe

fuertemente curvada

fortemente curvata

1:2

Hohlmeißelzangen
Bone rongeurs

Pinces gouges
Pinzas gubias
Pinze sgorbie

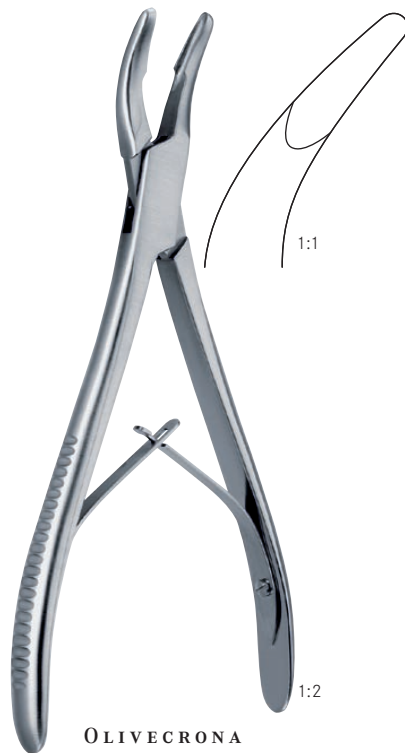

OLIVECRONA
205 mm – 8"
tk 24620-20

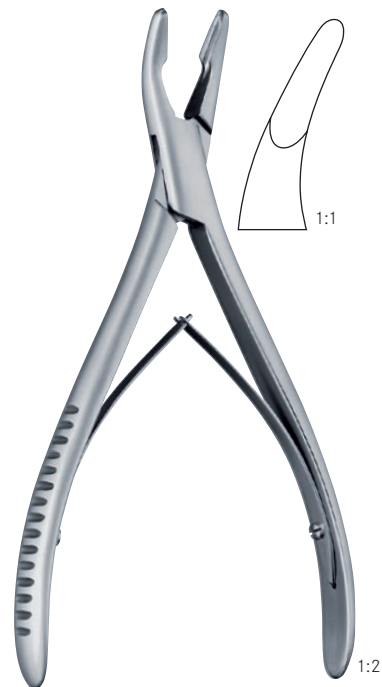

HARTMANN
175 mm – 7"
tk 24622-18

Hohlmeißelzangen
Bone rongeurs

Pinces gouges
Pinzas gubias
Pinze sgorbie



MEAD

165 mm – 6½"

tk 24631-16



1:1

CLEVELAND

170 mm – 6¾"

tk 24637-17

1:2



1:1

CLEVELAND

140 mm – 5½"

tk 24635-14

1:2

Hohlmeißelzangen | Pincés gougés
 Bone rongeurs | Pinzas gubias
 Pinze sgorbie



BÖHLER

150 mm – 6"

tk 24613-00

tk 24613-02

1:2

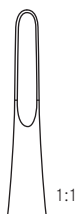

1:1



1:1



ZAUFAL-JANSEN

180 mm – 7"

tk 24614-18

1:2

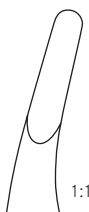

1:1



MARQUARDT

200 mm – 8"

tk 24614-20

1:2



1:1

Hohlmeißelzangen
Bone rongeurs

Pinces gouges
Pinzas gubias
Pinze sgorbie



BEYER

180 mm – 7"

tk 24615-18



RUSKIN

180 mm – 7"

tk 24616-05

tk 24616-04



MAYFIELD

175 mm – 7"

tk 24627-17

Hohlmeißelzangen
Bone rongeurs

Pinces gouges
Pinzas gubias
Pinze sgorbie



STILLE-
RUSKIN

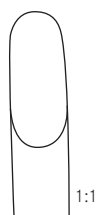

230 mm – 9"

tk 24617-23

tk 24618-23



STILLE

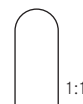

4 mm

6 mm

8 mm

230 mm – 9"

tk 24619-04



tk 24619-06

tk 24619-08



Hohlmeißelzangen
Bone rongeurs

Pinces gouges
Pinzas gubias
Pinze sgorbie



LEKSELL	 1:1	 1:1	 1:1
	4 mm	6 mm	8 mm
240 mm – 9½"	tk 24621-04	tk 24621-06	tk 24621-08

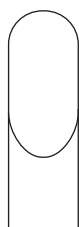

STILLE-LUER	 1:1	 1:1
220 mm – 8¾"	tk 24624-22	tk 24625-22

Hohlmeißelzangen | Pinces gouges
Bone rongeurs | *Pinzas gubias*
 Pinze sgorbie



**RÖTTGEN-
RUSKIN**

230 mm – 9"

tk 24629-23

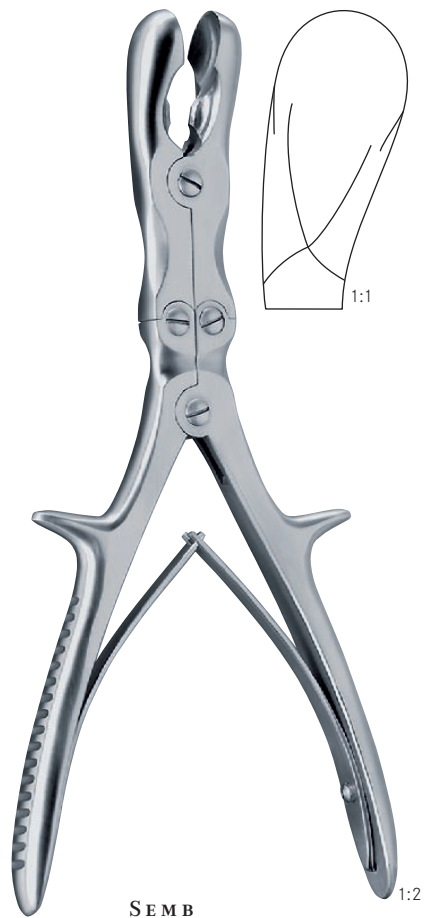

SEMB

240 mm – 9½"

tk 24630-23

Hohlmeißelzangen
Bone rongeurs

Pinces gouges
Pinzas gubias
Pinze sgorbie

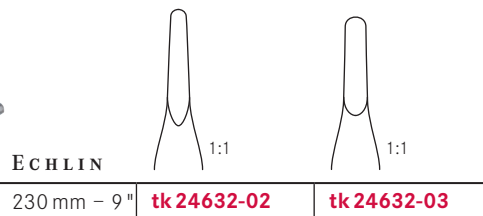

FRYKHOLM
240 mm – 9½"
tk 24634-24

Hohlmeißelzangen
Bone rongeurs

Pinces gouges
Pinzas gubias
Pinze sgorbie

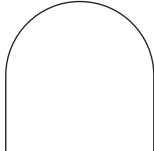

SAUERBRUCH		1:1		1:1
		Fig. 1		Fig. 2
300 mm – 12"	tk 24633-01		tk 24633-02	

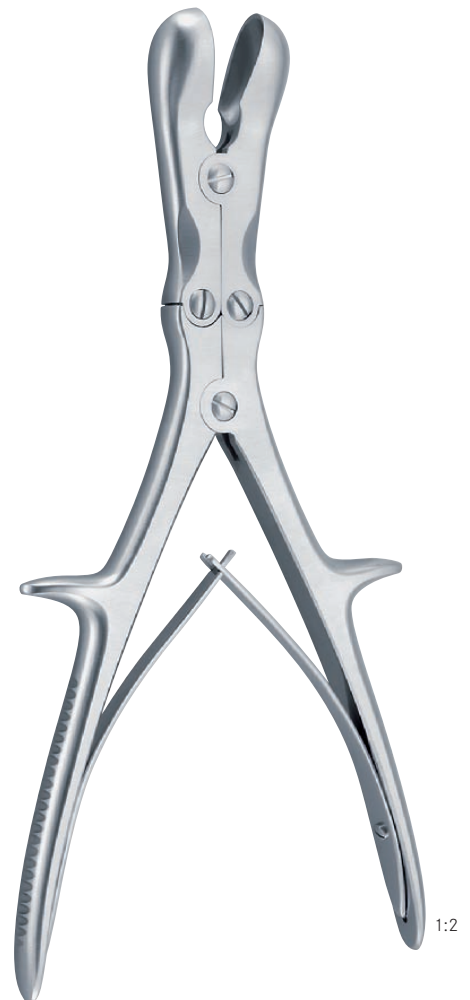

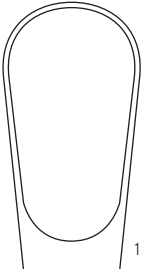
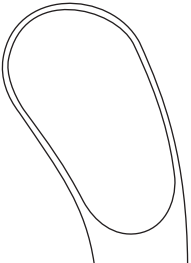
LUER-STILLE		1:1		1:1
270 mm – 10¾"	tk 24646-27		tk 24647-27	

Knochensplitterzangen
Bone cutting forceps

Pincés coupantes à os
Pinzas cortantes para huesos
Cesoie per ossa

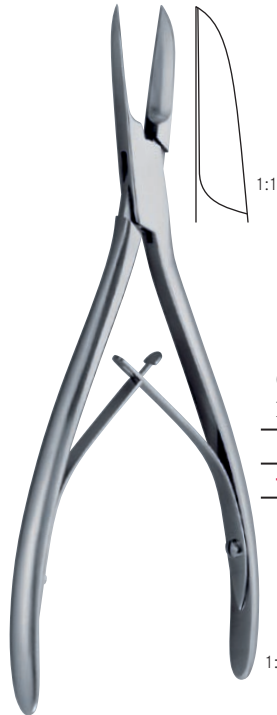

**COTTLE-
KAZANJIAN**

190 mm – 7½"

tk 24649-19



LISTON

140 mm – 5½"

tk 24650-14

tk 24651-14

170 mm – 6¾"

tk 24650-17

tk 24651-17

190 mm – 7½"

tk 24650-19

tk 24651-19

220 mm – 8¾"

tk 24650-22

tk 24651-22

Knochensplitterzangen
Bone cutting forceps

Pinces coupantes à os
Pinzas cortantes para huesos
Cesoie per ossa



BÖHLER

150 mm – 6"

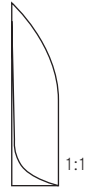

1:1



1:1

tk 24654-15

tk 24655-15



RUSKIN-
LISTON

185 mm – 7 1/4"



1:1



1:1

tk 24660-18

tk 24661-18



STILLE-
LISTON

270 mm – 10 3/4"

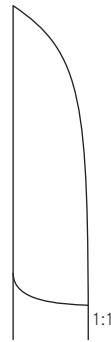

1:1



1:1

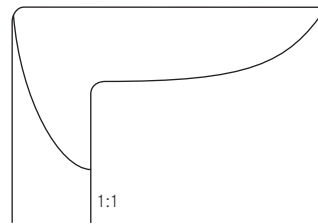

1:1

tk 24670-27

tk 24671-27

tk 24673-27

Knochensplitterzangen
Bone cutting forceps

Pincés coupantes à os
Pinzas cortantes para huesos
Cesoie per ossa



Knochenhalteklammern – Knochenhaltezangen
 Bone holding clamps – Bone holding forceps

Daviers à os – Daviers porte-os
 Pinzas porta huesos – Pinzas para huesos
 Tenaglie per ossa



1:2

GERSTER-LOWMANN

180 mm – 7"	x = 28 mm	tk 24696-18
200 mm – 8"	x = 35 mm	tk 24696-20
220 mm – 8¾"	x = 40 mm	tk 24696-22

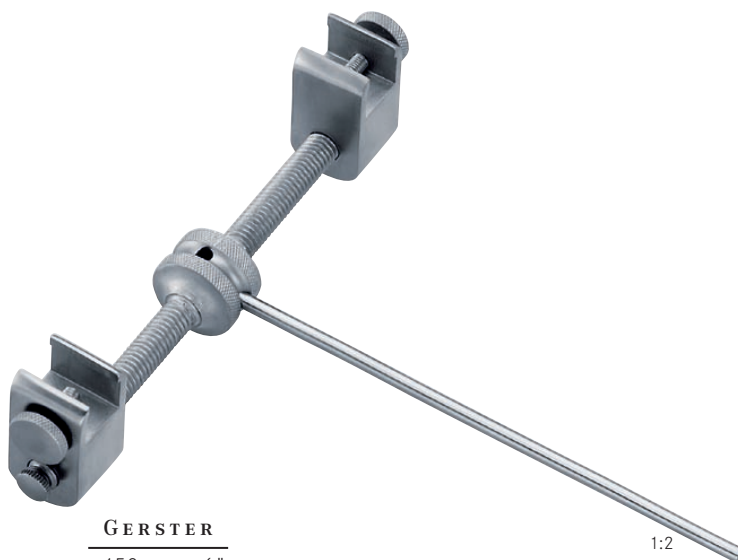

1:2

GERSTER

150 mm – 6"	tk 24698-00
-------------	--------------------

Knochenhaltezangen – Repositionszangen
Bone holding forceps – Reposition forceps

Daviers porte-os – Pincas de reposition
Pinzas para huesos – Pinzas para reposición
Tenaglie per ossa – Pinze per riposizioni

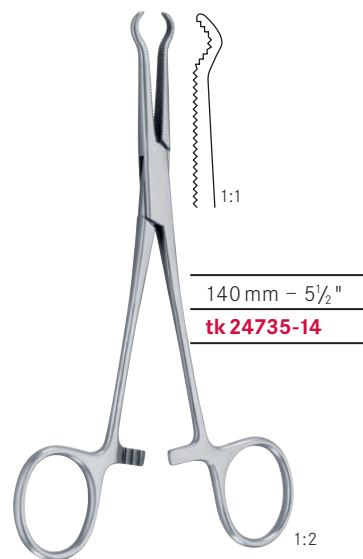

Knochenhalteklammern – Knochenhaltezangen
 Bone holding clamps – Bone holding forceps

Daviers à os – Daviers porte-os
 Pinzas porta huesos – Pinzas para huesos
 Tenaglie per ossa

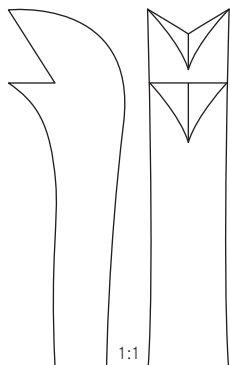

FERGUSSON

210 mm – 8 1/4"

tk 24700-21

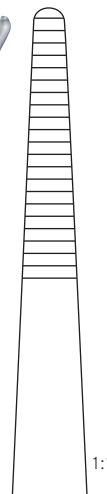

VAN BUREN

230 mm – 9"

tk 24701-23

Knochenhaltezangen
Bone holding forceps

Daviers porte-os
Pinzas para huesos
Tenaglie per ossa



LANGENBECK

210 mm – 8¼"

tk 24702-21



SEMB

190 mm – 7½"

tk 24704-19

Knochenhaltezangen
Bone holding forceps

Daviers porte-os
Pinzas para huesos
Tenaglie per ossa

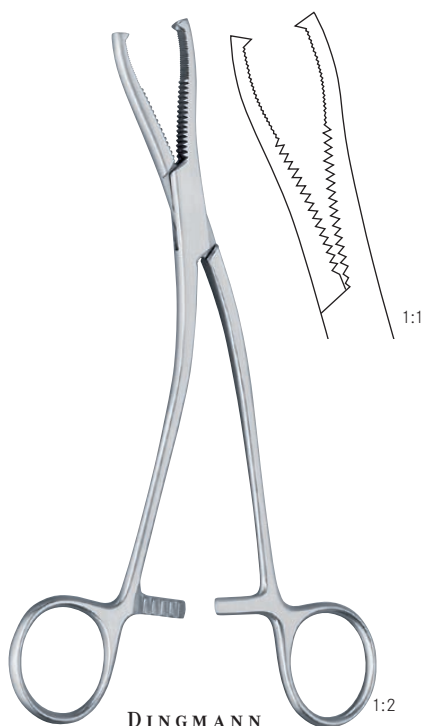

DINGMANN

190 mm – 7½"

tk 24705-19



200 mm – 8"

tk 24706-20

tk 24707-20

Sequesterzange

Sequestrum forceps

Pince pour Sequestrum

Pinza para Sequestrum

Pinza per Sequestrum

Knochenhaltezangen
Bone holding forceps

Daviers porte-os
Pinzas para huesos
Tenaglie per ossa



FARABEUF

230 mm – 9"	tk 24709-23
260 mm – 10¼"	tk 24709-26



FARABEUF-LAMBOTTE

260 mm – 10¼"	tk 24710-26
---------------	--------------------

Knochenhaltezangen
Bone holding forceps

Daviers porte-os
Pinzas para huesos
Tenaglie per ossa



1:1
MARTIN
190 mm – 7½"
tk 24712-19

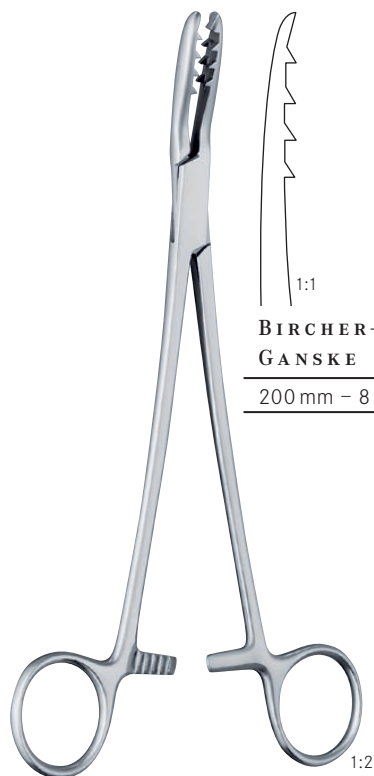

1:1
BIRCHER-GANSKE
200 mm – 8"
tk 24713-20 **tk 24714-20**

Knochenhaltezangen
Bone holding forceps

Daviers porte-os
Pinzas para huesos
Tenaglie per ossa

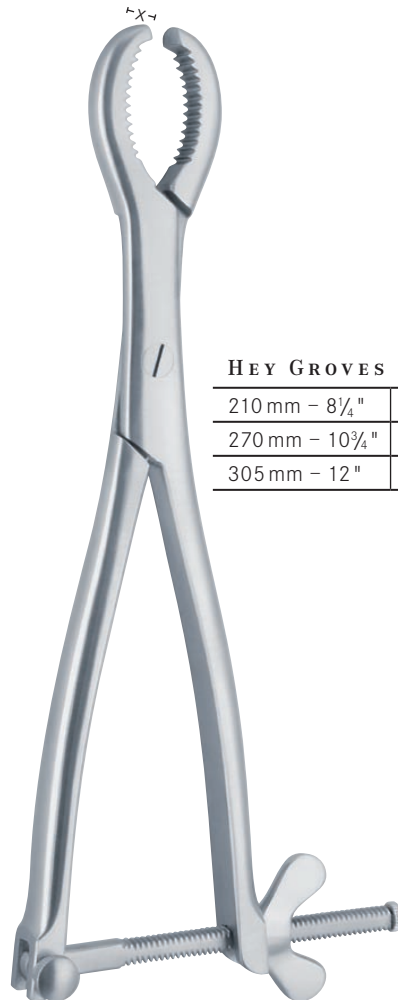

HEY GROVES

210 mm – 8¼"	x = 6.5 mm	tk 24724-21
270 mm – 10¾"	x = 7.5 mm	tk 24724-27
305 mm – 12"	x = 8.5 mm	tk 24724-30

Knochenhaltezangen
Bone holding forceps

Daviers porte-os
Pinzas para huesos
Tenaglie per ossa



VERBRUGGE	175 mm - 7"	250 mm - 10"	260 mm - 10¼"	270 mm - 10¾"
	x = 5.0 mm	x = 9.5 mm	x = 10.5 mm	x = 12.0 mm
	tk 24730-17	tk 24730-25	tk 24730-26	tk 24730-27

Knochenhaltezangen
Bone holding forceps

Daviers porte-os
Pinzas para huesos
Tenaglie per ossa



KERN

170 mm – 6¾"	tk 24720-17	tk 24721-17
210 mm – 8¼"	tk 24720-21	tk 24721-21

Knochenhaltezangen
Bone holding forceps

Daviers porte-os
Pinzas para huesos
Tenaglie per ossa



LANE

330 mm – 13"	tk 24722-33	tk 24723-33
450 mm – 17 ³ / ₄ "	tk 24722-45	tk 24723-45

Knochenhalte­zangen
Bone holding forceps

Daviers porte-os
Pinzas para huesos
Tenaglie per ossa



LAMBOTTE

220 mm – 8¾"	tk 24732-22
270 mm – 10¾"	tk 24732-27
300 mm – 12"	tk 24732-30

ein Maulteil beweglich
one jaw mobile

un mors mobile
una boca movable
una parte del morso mobile

150 mm – 6"	x = 2.5 mm	tk 24733-15
190 mm – 7½"	x = 6.5 mm	tk 24733-00
240 mm – 9½"	x = 9.5 mm	tk 24733-01
260 mm – 10¼"	x = 10.0 mm	tk 24733-02
280 mm – 11"	x = 11.0 mm	tk 24733-03

selbstzentrierend
self-centering

auto-centreur
autocentrante
autocentrante

Knochenhaltezangen
Bone holding forceps

Daviers porte-os
Pinzas para huesos
Tenaglie per ossa



ULRICH

230 mm – 9"	tk 24736-23	tk 24737-23
250 mm – 9¾"	tk 24736-25	tk 24737-25
280 mm – 11"	tk 24736-28	tk 24737-28

kniegebogen
angular
coudée
acodada
angolata



160 mm – 6¼"	tk 24738-16
240 mm – 9½"	tk 24738-24

Knochenhaltezangen – Repositionszangen
Bone holding forceps – Reposition forceps

Daviers porte-os – Pincas de reposition
Pinzas para huesos – Pinzas para reposición
Tenaglie per ossa – Pinze per riposizione

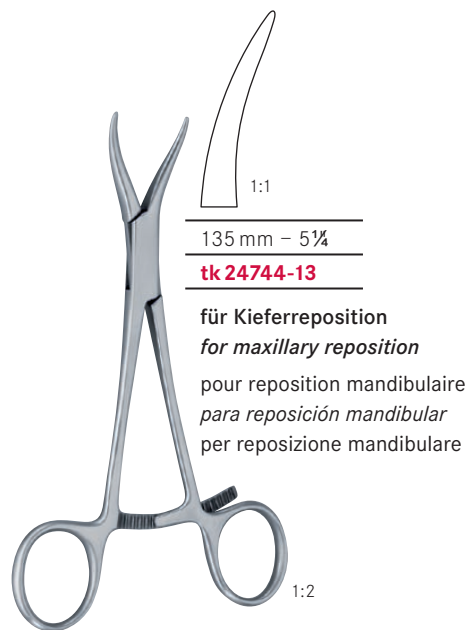
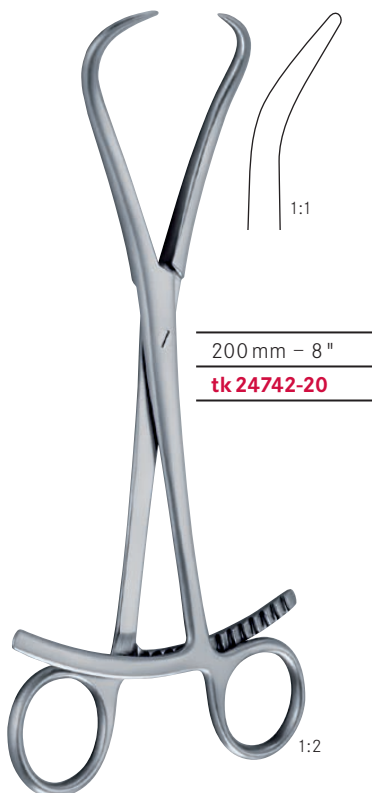

Repositionszangen
Reposition forceps

Pinces de reposition
Pinzas para reposición
 Pinze per riposizione

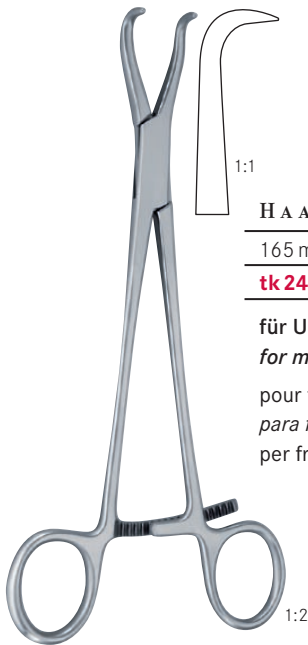

1:1

HAASE

165 mm – 6½"

tk 24745-16

für Unterkieferfrakturen
for mandibular fractures

pour fractures mandibulaires
para fracturas del mandibulo
 per fratture mandibulare

1:2

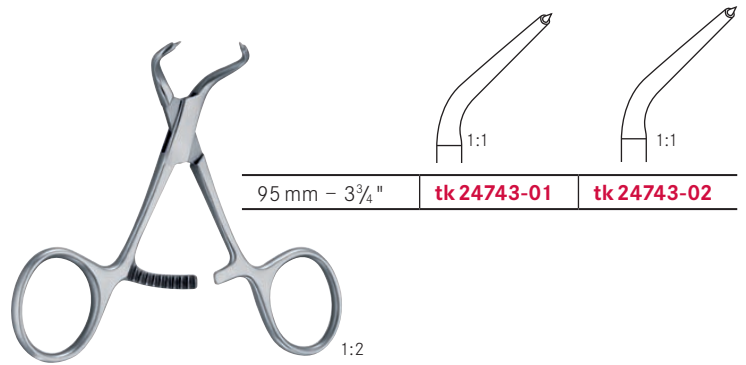

1:1

1:1

95 mm – 3¾"

tk 24743-01

tk 24743-02

1:2

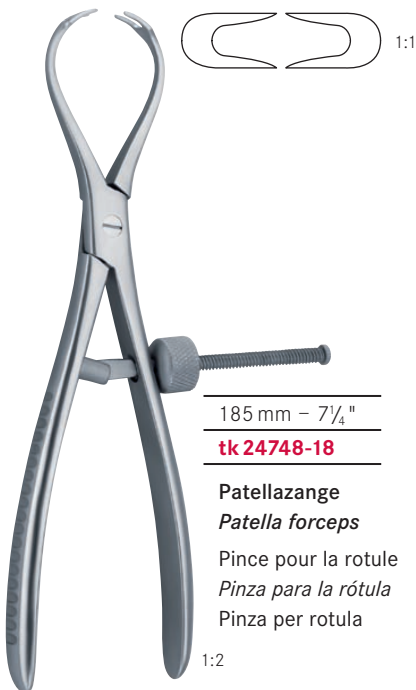

1:1

185 mm – 7¼"

tk 24748-18

Patellazange
Patella forceps

Pince pour la rotule
Pinza para la rótula
 Pinza per rotula

1:2



1:1

210 mm – 8¼"

tk 24749-21

Knöchelfasszange
Malleolar forceps

Pince pour le malléole
Pinza para el maleolo
 Pinza per malleolo

1:2

Draht-Instrumentarium
Wire instruments

Instruments pour cerclage
Instrumental para cerclaje
Strumenti per filo di cerchiaggio



DEMEL	280 mm – 11 "
x = 32 mm	tk 38517-01
x = 45 mm	tk 38517-02
x = 62 mm	tk 38517-03



DEMEL	280 mm – 11 "
	tk 38518-28

Draht-Instrumentarium
Wire instruments

Instruments pour cerclage
Instrumental para cerclaje
Strumenti per filo di cerchiaggio



LOUTE

210 mm – 8 1/4"

tk 38520-21

1:2



130 mm – 5"

tk 38532-13

1:2



0.2 mm Ø	tk 38550-02
0.3 mm Ø	tk 38550-03
0.4 mm Ø	tk 38550-04
0.5 mm Ø	tk 38550-05
0.6 mm Ø	tk 38550-06
0.7 mm Ø	tk 38550-07
0.8 mm Ø	tk 38550-08
0.9 mm Ø	tk 38550-09
1.0 mm Ø	tk 38550-10
1.2 mm Ø	tk 38550-12
1.5 mm Ø	tk 38550-15

Knochendraht, weich, in Ringen à 10 m
Bone wire, soft, in coils of 10 m

Fil de cerclage, souple, de 10 m
Alambre de cerclaje, blando, de 10 m
Filo per ossa, morbida, anelli da 10 m



0.8 mm Ø x 280 mm	tk 38552-08
1.0 mm Ø x 280 mm	tk 38552-10
1.2 mm Ø x 280 mm	tk 38552-12
1.0 mm Ø x 600 mm	tk 38553-10
1.2 mm Ø x 600 mm	tk 38553-12

Knochendraht mit Auge, weich, Packung à 10 Stück
Bone wire with eye, soft, package of 10 pieces

Fil de cerclage, souple, paquet de 10 pièces
Alambre de cerclaje, blando, paquete de 10 piezas
Filo per ossa con ansa, morbida, pacchetto di 10 pezzi

Drahtschneidezangen
Wire cutting forceps

Pinces coupantes
Alicates para cortar alambre
Pinze taglia filo

TUCARTK



220 mm – 8³/₄"

tk 38561-22 tucart

für harte Drähte bis 2.2 mm Ø, für weiche Drähte bis 3 mm Ø
for hard wires up to 2.2 mm Ø, for soft wires up to 3 mm Ø

pour fils durs à diam. 2.2 mm Ø, pour fils souples à 3 mm Ø
para alambres duros hasta 2.2 mm Ø, y alambres blandos de 3 mm Ø
per fili duri fina 2.2 mm Ø, per fili morbidi fino a 3 mm Ø



220 mm – 8³/₄"

tk 38554-22 tucart

für harte Drähte bis 2.2 mm Ø, für weiche Drähte bis 2.8 mm Ø
for hard wires up to 2.2 mm Ø, for soft wires up to 2.8 mm Ø

pour fils durs à 2.2 mm Ø, pour fils souples à 2.8 mm Ø
para alambres duros hasta 2.2 mm Ø, y alambres blandos de 2.8 mm Ø
per fili duri fina 2.2 mm Ø, per fili morbidi fino a 2.8 mm Ø



230 mm – 9"

tk 38554-23 tucart

für harte Drähte bis 2.2 mm Ø, für weiche Drähte bis 3 mm Ø
for hard wires up to 2.2 mm Ø, for soft wires up to 3 mm Ø

pour fils durs à 2.2 mm Ø, pour fils souples à 3 mm Ø
para alambres duros hasta 2.2 mm Ø, y alambres blandos de 3 mm Ø
per fili duri fina 2.2 mm Ø, per fili morbidi fino a 3 mm Ø

Drahtschneidezangen
Wire cutting forceps

Pinces coupantes
Alicates para cortar alambre
Pinze taglia filo



1:2

180 mm – 7"

tk38555-18 tucarc

für harte Drähte bis 1.5 mm Ø, für weiche Drähte bis 2 mm Ø
for hard wires up to 1.5 mm Ø, for soft wires up to 2 mm Ø
pour fils durs à 1.5 mm Ø, pour fils souples à 2 mm Ø
para alambres duros hasta 1.5 mm Ø, y alambres blandos de 2 mm Ø
per fili duri fina 1.5 mm Ø, per fili morbidi fino a 2 mm Ø



1:2

180 mm – 7"

tk38557-18 tucarc

für harte Drähte bis 1.7 mm Ø, für weiche Drähte bis 2 mm Ø
for hard wires up to 1.7 mm Ø, for soft wires up to 2 mm Ø
pour fils durs à 1.7 mm Ø, pour fils souples à 2 mm Ø
para alambres duros hasta 1.7 mm Ø, y alambres blandos de 2 mm Ø
per fili fina 1.7 mm Ø, per fili morbidi fino a 2 mm Ø



1:2

150 mm – 6"

tk38556-15 tucarc

für harte Drähte bis 1 mm Ø, für weiche Drähte bis 1.5 mm Ø
for hard wires up to 1 mm Ø, for soft wires up to 1.5 mm Ø
pour fils durs à 1 mm Ø, pour fils souples à 1.5 mm Ø
para alambres duros hasta 1 mm Ø, y alambres blandos de 1.5 mm Ø
per fili duri fina 1 mm Ø, per fili morbidi fino a 1.5 mm Ø



1:2

145 mm – 5¾"

tk38561-14 tucarc

für harte Drähte bis 1 mm Ø
for hard wires up to 1 mm Ø
pour fils durs à 1 mm Ø
para alambres duros hasta 1 mm Ø
per fili duri fino a 1 mm Ø

Drahtschneidezangen
Wire cutting forceps

Pinces coupantes
Alicates para cortar alambre
Pinze taglia filo



570 mm – 22½" | **tk 38558-57**

für Kirschner Drähte und Steinmann Nägel bis 6 mm Ø
for Kirschner wires and Steinmann pins up to 6 mm Ø
pour des broches Kirschner et clous Steinmann à 6 mm Ø
para agujas de Kirschner y clavos de Steinmann hasta 6 mm Ø
per fili Kirschner e chiodi Steinmann fino a 6 mm Ø

1:3

Drahtschneidezangen
Wire cutting forceps

Pinces coupantes
Alicates para cortar alambre
Pinze taglia filo



185 cm – 7 $\frac{1}{4}$ "

tk38560-04

Kopfschneider, durchbohrt für harte Drähte bis 1.6 mm Ø
Wire cutting forceps for hard wires up to 1.6 mm Ø

Pince coupante pour fils durs à 1.6 mm Ø
Alicate para alambres duros hasta 1.6 mm Ø
Pinza taglia fili per fili duri fino a 1.6 mm Ø



260 mm – 10 $\frac{1}{4}$ "

tk38560-26 tucar

für harte Drähte bis 3 mm Ø
for hard wires up to 3 mm Ø

pour fils durs à 3 mm Ø
para alambres duros hasta 3 mm Ø
per fili duri fino a 3 mm Ø

TUCAR

Technische Zangen
Technical forceps

Pincas técnicas
Pinzas técnicas
Pinze tecniche



130 mm – 5"	tk 38562-13
180 mm – 7"	tk 38562-18



140 mm – 5½"	tk 38563-14
170 mm – 6¾"	tk 38563-17



	180 mm – 7"	180 mm – 7"
x = 5 mm	tk 38564-05	tk 38571-05 tucar
x = 7 mm	tk 38564-07	tk 38571-07 tucar

TUCAR

Technische Zangen
Technical forceps

Pinces techniques
Pinzas tecnicas
 Pinze tecniche



170 mm – 6¾" 1:2

tk38565-17



220 mm – 8¾" 1:2

tk38565-22 tucar

Grip-Zange, kombiniert mit TC-Schneider
Grip forceps, combined with TC-Cutter

Pince grip, avec partie coupante TC
Pinza grip, con parte cortante TC
 Pinza grip, con morso tagliante a TC



190 mm – 7½" 1:2

tk38565-19

Technische Zange, verstellbar
Technical forceps, adjustable

Pince technique, ajustable
Pinza tecnica, ajustable
 Pinza tecnica, regolabile



Technische Zangen
Technical forceps

Pincés técnicas
Pinzas técnicas
Pinze tecniche



185 mm – 7¼" | **tk 38569-17**

Drahtbiegezange
Wire bending forceps
Pince à couder
Pinza para torcer
Pinza per piegare



185 mm – 7¼" | **tk 38569-01**

Flachzange mit Seitenschneider, parallelfassend, für harte Drähte bis 1.6 mm Ø
Flat nose plier, parallel grip, incorporated cutter, for hard wires up to 1.6 mm Ø
Pince à couder avec coupe latéral, pour des fils durs à de 1.6 mm Ø
Pinza para torcer con corte lateral, para alambres hasta 1.6 mm Ø
Pinza, morso piatto parallelo e taglia fili laterale fino a 1.6 mm Ø



180 mm – 7" | **tk 38573-18**
200 mm – 8" | **tk 38573-20**
240 mm – 9½" | **tk 38573-24**

Feststellzange
Locking plier
Pince à caler
Pinza de fijar
Pinza bloccante

Technische Zangen
Technical forceps

Pinces techniques
Pinzas tecnicas
 Pinze tecniche



220 mm – 8 $\frac{3}{4}$ "	tk 38573-05
250 mm – 9 $\frac{3}{4}$ "	tk 38573-03
300 mm – 12"	tk 38573-04

Feststellzange, allein
Locking plier, only

Pince à caler, seul
Pinza de fijar, sola,
 Pinza bloccante, sola

300 mm – 12"	tk 38573-08
--------------	--------------------

Feststellzange mit Aufnahmestift
Locking plier with holding pins

Pince à caler avec groupilles
Pinza de fijar con pivotes
 Pinza bloccante con perni per estrattore

460 mm – 18"	tk 38573-09
--------------	--------------------

Feststellzange mit Ausschlagvorrichtung
Locking plier with extraction device

Pince à caler avec devis d'extraction
Pinza de fijar con dispositivo de extracción
 Pinza bloccante con estrattore

1:2

Technische Zangen
Technical forceps

Pincés técnicas
Pinzas técnicas
Pinze tecniche



200 mm – 8" | **tk 38573-01**

Plattenbiegezange für Knochenplatten bis 2.7 mm Stärke
Plate bending plier for plates up to 2.7 mm

Pince à couder pour des plaques de 2.7 mm
Pinza para torcer, placas hasta 2.7 mm
Pinza piega placche fino a 2.7 mm

240 mm – 9½" | **tk 38573-02**

Plattenbiegezange für Knochenplatten bis 4 mm Stärke
Plate bending plier for plates up to 4 mm

Pince à conder pour des plaques de 4 mm
Pinza para torcer, para placas hasta 4 mm
Pinza piega placche fino a 4 mm



Bitte fordern Sie unseren Spezialkatalog für Traumatologie an.
Please ask for our special catalogue for traumatology.

Veuillez demander pour notre catalogue spécial pour la traumatologie.
Por favor preguntan para el catalogo especial para la traumatología.

Per favore domandate per il nostro catalogo speciale per la traumatologia.

Extensionsbügel
Extension bows

Etriers pour extension
Estribos para extensión
Archi per estensione



tk 38583-18 | 180 mm – 7"

Spannschlüssel für Kirschner Drähte
Wire strainer for Kirschner wires

Tendeur pour fils de Kirschner
Tensor para agujas de Kirschner
Chiave per estensione di fili Kirschner

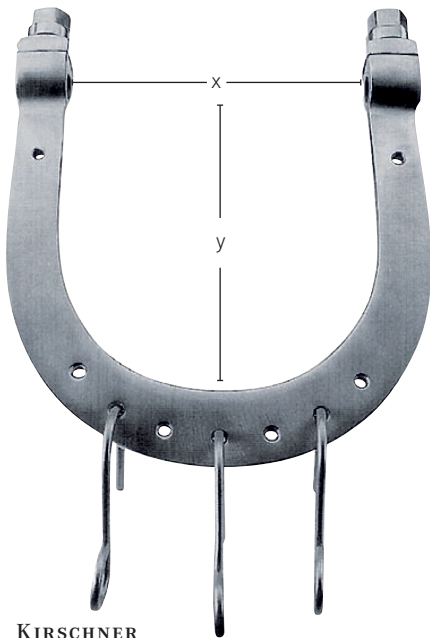

KIRSCHNER

x = 95 mm	y = 70 mm	tk 38580-01
x = 100 mm	y = 100 mm	tk 38580-02
x = 120 mm	y = 120 mm	tk 38580-03
x = 155 mm	y = 155 mm	tk 38580-04
x = 200 mm	y = 155 mm	tk 38580-05

mit 3 Zughaken
with 3 traction hooks
avec 3 crochets d'attelage
con 3 ganchos de tracción
con 3 ganci di trazione



KIRSCHNER

x = 130 mm	tk 38581-01
x = 185 mm	tk 38581-02
x = 220 mm	tk 38581-03

mit 3 Zughaken
with 3 traction hooks
avec 3 crochets d'attelage
con 3 ganchos de tracción
con 3 ganci di trazione

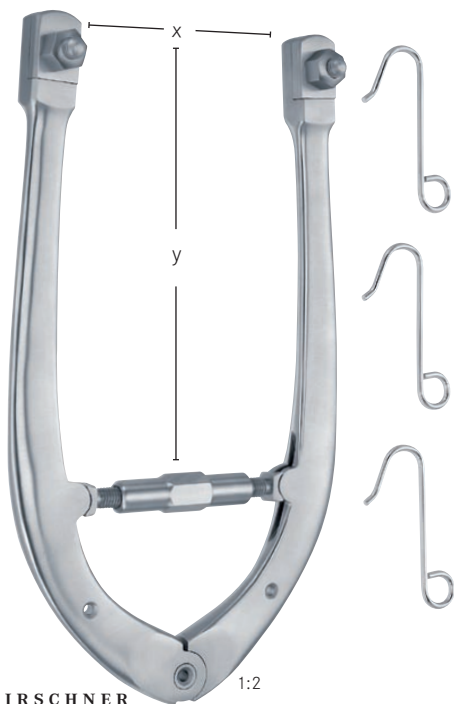
Extensionsbügel
Extension bows
Etriers pour extension
Estribos para extensión
Archi per estensione

KIRSCHNER 1:2

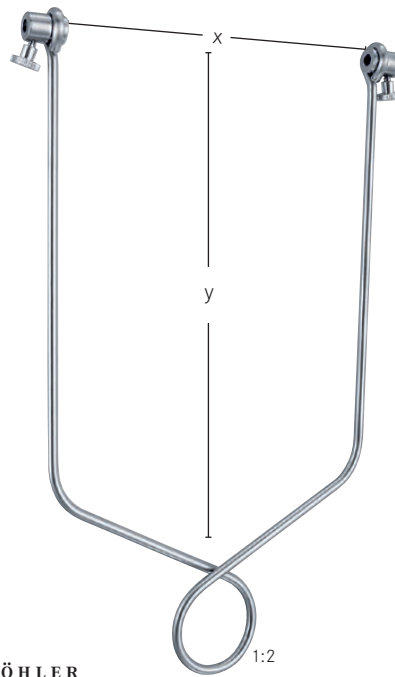
x = 180 mm	y = 100 mm	tk 38582-01
x = 270 mm	y = 160 mm	tk 38582-02

mit 3 Zughaken
with 3 traction hooks
avec 3 crochets d'attelage
con 3 ganchos de tracción
con 3 ganci di trazione

BÖHLER 1:2

x = 75 mm	y = 90 mm	tk 38596-75
x = 90 mm	y = 160 mm	tk 38597-90
x = 110 mm	y = 210 mm	tk 38598-11
x = 150 mm	y = 210 mm	tk 38598-21



1:2

	14 mm / 17 mm
190 mm – 7½"	tk 38584-19

Gabelschlüssel
Wrench
Clé de serrage
Llave de tuercas
Chiave per madreviti

Amputationsretraktor – Komprimeter
Amputation retractor – Comprimeter

Rétracteur pour amputation – Comprimètre
Retractor para amputación – Comprimetro
 Retrattore per amputazione – Comprimetro



PERCY

tk38599-00

1:3

Griffe abnehmbar, einfaches Modell
Handles detachable, simple pattern
 Manches à détacher, modèle simple
Mango desmontable, modelo simple
 Manici demontabili, modello semplice



tk4720-00

Komprimeter, bestehend aus Arm- und Oberschenkelmanschette,
 Manometer justiert bis 700 mm Hg und Metallpumpe
*Comprimeter, consisting of arm and upper thigh cuff,
 manometer calibrated up to 700 mm Hg, with metal pump*
 Comprimètre se composant du brassard pour bras et cuisse,
 manomètre calibré jusqu'à 700 mm Hg, avec pompe métallique
*Comprimetro, se compuesto de brazalete para brazo y muslo,
 manómetro calibrado hasta 700 mm Hg, con bomba metálica*
 Comprimetro, composto da torniquete, due bracciali e pompa d'aria
 e manometro graduato fino a 700 mm Hg

Handbohrapparate
Hand drills

Perforateurs à main
Perforadores de mano
Perforatori a mano

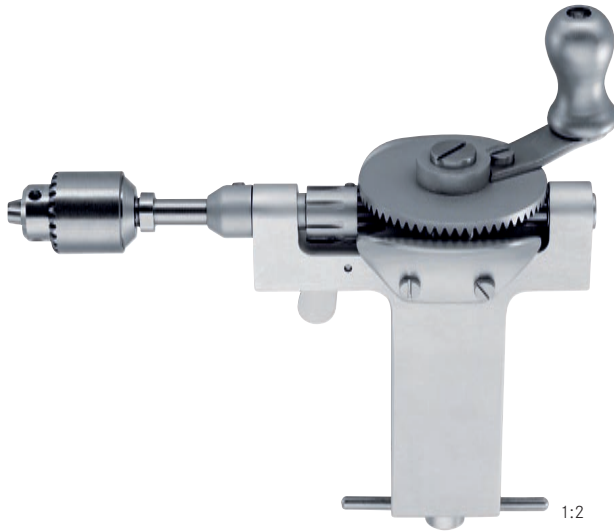

BUNELL

160 mm – 6¼" **tk 24860-00**

Öffnung bis 4 mm Ø
Opening up to 4 mm Ø

Ouverture jusqu'à 4 mm Ø
Apertura hasta 4 mm Ø
Apertura fino à 4 mm Ø

Leichtmetallgehäuse
Light metal housing

Carcasse en métal léger
Carcasa en metal ligero
In scatola di alluminio

Längsdurchbohrt
Longitudinally cannulated

À perforation axiale
Taladrado longitudinalmente
Forato longitudinalmente

tk 24860-01

Ersatzschlüssel für tk 24860-00
Spare key for tk 24860-00

Clé de réchange pour tk 24860-00
Llave de recambio para tk 24860-00
Chiave di ricambio per tk 24860-00



RALK

160 mm – 6¼" **tk 24862-00**

Öffnung bis 6,35 mm Ø
Opening up to 6.35 mm Ø

Ouverture jusqu'à 6.35 mm Ø
Apertura hasta 6.35 mm Ø
Apertura fino à 6.35 mm Ø

Leichtmetallgehäuse
Light metal housing

Carcasse en métal léger
Carcasa en metal ligero
In scatola di alluminio

Längsdurchbohrt
Longitudinally cannulated

À perforation axiale
Taladrado longitudinalmente
Forato longitudinalmente

Handbohrapparate
Hand drills

Perforateurs à main
Perforadores de mano
Perforatori a mano



STILLE

200mm – 8"

tk 24855-00

komplett mit 9 Bohrern (Fig. 1 – Fig. 9)
complete with 9 twist drills (Fig. 1 – Fig. 9)

complet avec 9 mèches (Fig. 1 – Fig. 9)
completa con 9 fresas (Fig. 1 – Fig. 9)
completa con 9 frese (Fig. 1 – Fig. 9)

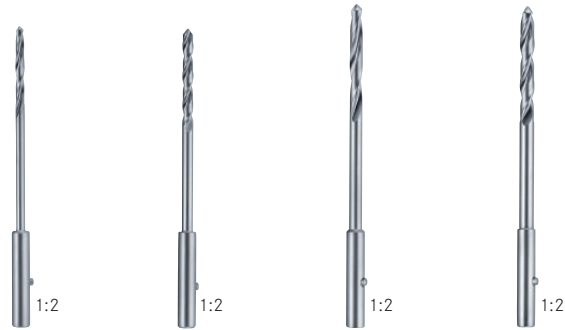

Fig. 1	Fig. 2	Fig. 3	Fig. 4
2.5 mm Ø	3.0 mm Ø	3.5 mm Ø	4.0 mm Ø
tk 24855-01	tk 24855-02	tk 24855-03	tk 24855-04



Fig. 7	Fig. 8	Fig. 9
8.0 mm Ø	12.0 mm Ø	16.0 mm Ø
tk 24855-07	tk 24855-08	tk 24855-09



Fig. 10	Fig. 11	Fig. 12
1.0 mm Ø	1.5 mm Ø	2.0 mm Ø
tk 24855-10	tk 24855-11	tk 24855-12

Handbohrapparate
Hand drills

Perforateurs à main
Perforadores de mano
Perforatori a mano

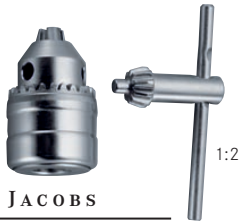

JACOBS

280 mm – 11 "

tk 24864-06

Öffnung bis 6,35 mm Ø
Opening up to 6.35 mm Ø
Ouverture jusqu'à 6.35 mm Ø
Apertura hasta 6.35 mm Ø
Apertura fino à 6.35 mm Ø



tk 24859-06

Öffnung bis 6,35 mm Ø
Opening up to 6.35 mm Ø
Ouverture jusqu'à 6.35 mm Ø
Apertura hasta 6.35 mm Ø
Apertura fino à 6.35 mm Ø

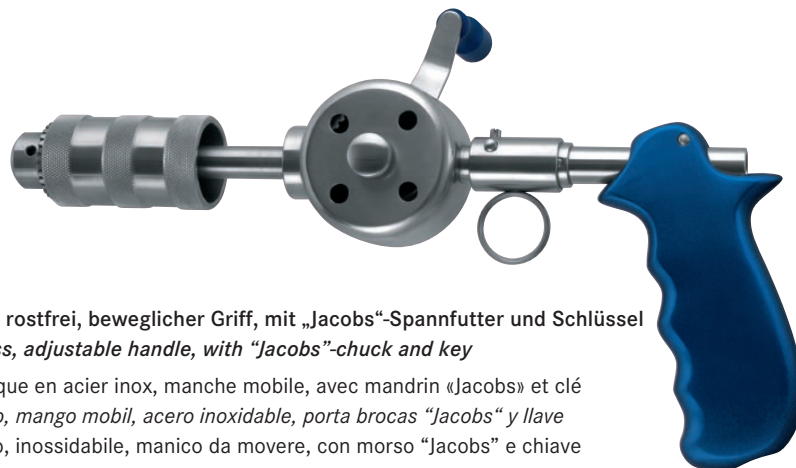

280 mm – 11 "

tk 24863-00

Handbohrapparat, rostfrei, beweglicher Griff, mit „Jacobs“-Spannfutter und Schlüssel
Hand drill, stainless, adjustable handle, with „Jacobs“-chuck and key

Perceuse mécanique en acier inox, manche mobile, avec mandrin «Jacobs» et clé
Taladradora a mano, mango mobil, acero inoxidable, porta brocas „Jacobs“ y llave
Perforatore a mano, inossidabile, manico da muovere, con morso „Jacobs“ e chiave

1:3

Spiralbohrer – Pfrieme
 Twist drills – Reamers

Mêches – Alênes
 Taladros espirales – Escariadores
 Punte a spirale – Perforatori a mano



1.0 mm Ø		tk 24885-10
1.5 mm Ø		tk 24885-15
2.0 mm Ø	tk 24880-20	tk 24885-20
2.5 mm Ø	tk 24880-25	tk 24885-25
2.8 mm Ø		tk 24885-28
3.0 mm Ø	tk 24880-30	tk 24885-30
3.2 mm Ø	tk 24880-32	tk 24885-32
3.5 mm Ø	tk 24880-35	tk 24885-35
4.0 mm Ø	tk 24880-40	tk 24885-40
5.0 mm Ø	tk 24880-50	tk 24885-50
6.0 mm Ø	tk 24880-60	tk 24885-60
7.0 mm Ø	tk 24880-70	tk 24885-70

AO Schaft	Rundschaft
AO shank	Round shank
Raccord AO	Tige ronde
Connector AO	Tija redonda
Attacco AO	Asta rotondo

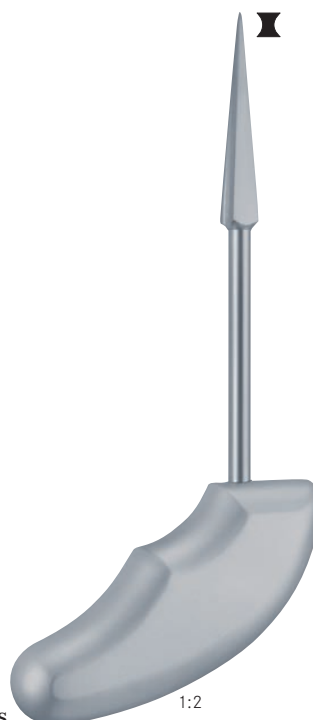

PERTHES	
180 mm – 7"	tk 24899-18
210 mm – 8 1/4"	tk 24899-21



140 mm – 5 1/2"
tk 24864-14



140 mm – 5 1/2"
tk 24898-14

